

PRODUCT INFORMATION PACKET

Model No: TCM0152A2113GAC011

Catalog No: TCM0152A2113GAC011

TerraMAX® IE3, Mining Duty Motors, 15 kW, 3Ph, 4 Pole, 400/690V, B3, 50Hz, 160L Frame, TEFC

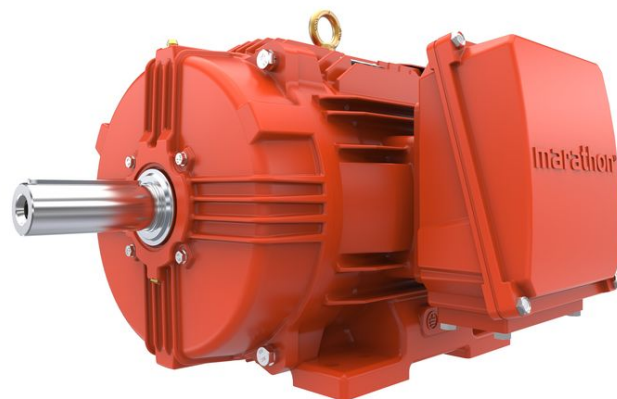

Regal and Marathon are trademarks of Regal Rexnord Corporation or one of its affiliated companies.

©2022 Regal Rexnord Corporation, All Rights Reserved. MC017097E

Nameplate Specifications

| | | | |
|------------------------|----------------------|----------------------------|------------------------------------|
| Output HP | 20 Hp | Output KW | 15.0 kW |
| Frequency | 50 Hz | Voltage | 400/690 V |
| Current | 27.7 A | Speed | 1476 rpm |
| Service Factor | 1 | Phase | 3 |
| Efficiency | 92.1 % | Power Factor | 0.85 |
| Duty | S1 | Insulation Class | H |
| Frame | 160L | Enclosure | Totally Enclosed Fan Cooled |
| Thermal Protection | No Protection | Ambient Temperature | 40 °C |
| Drive End Bearing Size | 6309 | Opp Drive End Bearing Size | 6209 |
| UL | NO | CSA | NO |
| CE | YES | IP Code | 66 |
| Number of Speeds | 1 | Efficiency Class | IE3 |

Technical Specifications

| | | | |
|-----------------------|----------------------|-----------------------|-----------------------|
| Electrical Type | Squirrel Cage | Starting Method | Direct On Line |
| Poles | 4 | Rotation | Bi-Directional |
| Mounting | B3 | Motor Orientation | Horizontal |
| Drive End Bearing | C3 | Opp Drive End Bearing | C3 |
| Frame Material | Cast Iron | Shaft Type | Keyed |
| Overall Length | 666 mm | Frame Length | 298 mm |
| Shaft Diameter | 42 mm | Shaft Extension | 110 mm |
| Assembly/Box Mounting | RHS | | |
| Connection Drawing | 8442000085 | Outline Drawing | 0216000925 |

This is an uncontrolled document once printed or downloaded and is subject to change without notice. Date Created:12/02/2022

OUTLINE

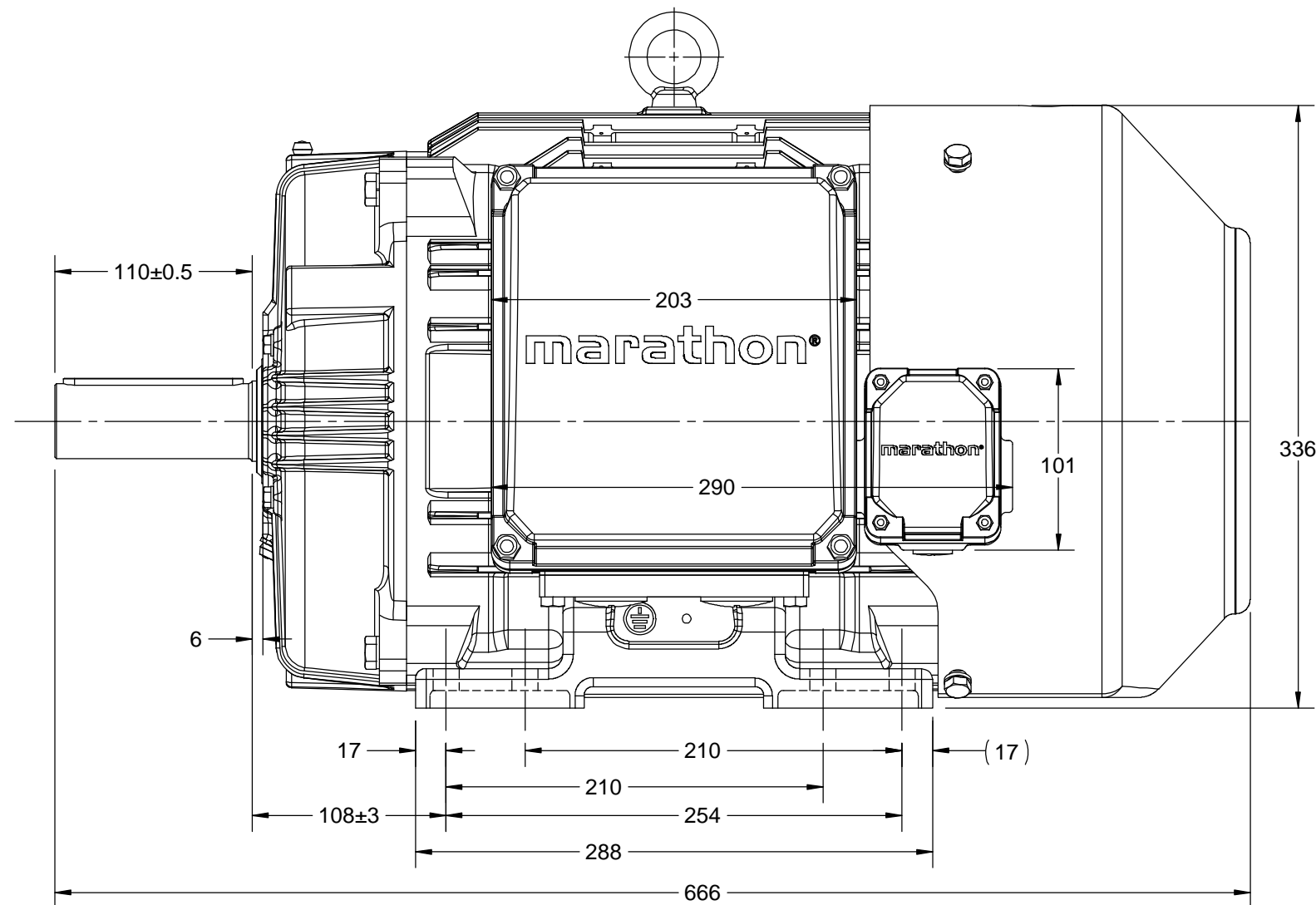
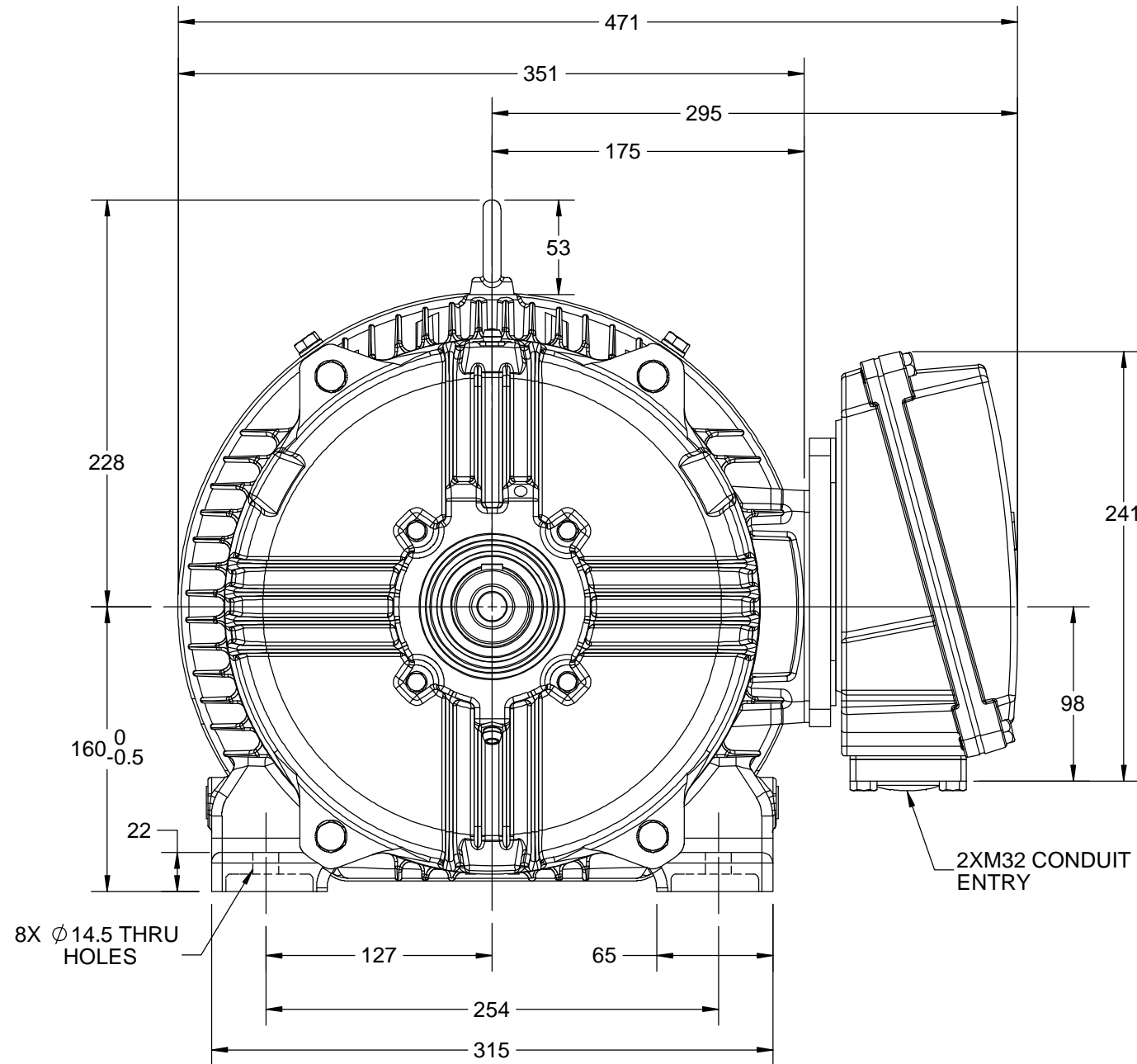
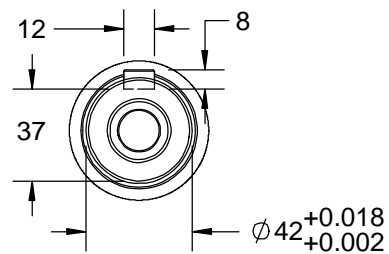

| | | |
|---|----------------------|--------------------|
| DRAWING REVISION B | REVISION BY BISWA | DATE 23/08/2018 |
| ECO ECO-0150058 | APPROVED BY SBD | DATE 23/08/2018 |
| ECO DESCRIPTION MODEL UPDATED WITH NEW STRUCTURE | | |
| <small>COPYRIGHT REGAL BELOIT AMERICA, INC. ALL RIGHTS RESERVED. PROPRIETARY AND CONFIDENTIAL INFORMATION - THIS DOCUMENT IS THE PROPERTY OF REGAL BELOIT AMERICA, INC. ("OWNER") AND CONTAINS OWNER'S PROPRIETARY INFORMATION. ANY PERSON, CORPORATION OR OTHER FIRM RECEIVING IT IS DEEMED, BY RECEIVING IT, TO AGREE THAT IT, AND/OR ANY PART OF IT, SHALL NOT BE DISCLOSED TO ANY PERSON, CORPORATION OR OTHER ENTITY, DUPLICATED, AND/OR USED, EXCEPT AS EXPRESSLY APPROVED IN WRITING IN ADVANCE BY OWNER. THIS DOCUMENT SHALL BE RETURNED TO OWNER UPON REQUEST. IT MAY BE SUBJECT TO CERTAIN RESTRICTIONS UNDER APPLICABLE EXPORT CONTROL LAWS AND REGULATIONS.</small> | | |

| |
|---------------------------|
| DRAWN BY LK |
| DATE 18/12/2017 |
| APPROVED BY SBD |
| DATE 18/12/2017 |
| REFERENCE |
| THIRD ANGLE PROJECTION |

| | |
|---|-------------------------------------|
| marathon™ Motors | |
| DESCRIPTION OUTLINE 160L FR B3-MTG.TYPE: TCM | |
| MATERIAL | PROCESS/FINISH |
| SIZE B | DRAWING NUMBER 0216000925 |
| SHEET 1 OF 1 | |

COPYRIGHT REGAL BELOIT AMERICA, INC. ALL RIGHTS RESERVED. PROPRIETARY AND CONFIDENTIAL INFORMATION - THIS DOCUMENT IS THE PROPERTY OF REGAL BELOIT AMERICA, INC. ("OWNER") AND CONTAINS OWNER'S PROPRIETARY INFORMATION. ANY PERSON, CORPORATION OR OTHER FIRM RECEIVING IT IS DEEMED, BY RECEIVING IT, TO AGREE THAT IT, AND/OR ANY PART OF IT, SHALL NOT BE DISCLOSED TO ANY PERSON, CORPORATION OR OTHER ENTITY, DUPLICATED, AND/OR USED, EXCEPT AS EXPRESSLY APPROVED IN WRITING IN ADVANCE BY OWNER. THIS DOCUMENT SHALL BE RETURNED TO OWNER UPON REQUEST. IT MAY BE SUBJECT TO CERTAIN RESTRICTIONS UNDER APPLICABLE EXPORT CONTROL LAWS AND REGULATIONS.

| | | |
|---|---------------------------|---------------------------|
| DRAWING REVISION A | REVISION BY SN | DATE 13/01/2017 |
| ECO ECO-0116390 | APPROVED BY SBD | DATE 13/01/2017 |
| ECO DESCRIPTION NEW DRAWING RELEASE | | |

| GEOMETRIC TOLERANCE | | |
|---------------------|---------|------|
| LINEAR DIM | >0~6 | ±0.1 |
| | >6~30 | ±0.2 |
| | >30~120 | ±0.3 |



NOTES:

1. PRESSURE-SENSITIVE ADHESIVE COATED PAPER ON THE BACK OF SELF-ADHESIVE.
2. AT THE END OF YELLOW, WORDS, SYMBOLS, LETTERS ARE BLACK, BORDER IS BLACK.
3. THE TOLERANCE OF THE LINEAR SIZE OF THE TOLERANCE WITHOUT THE TOLERANCE BY THE TABLE.

8WD.442.2017



| | | | |
|-----------------------|--|------------------|--|
| DRAWN BY SN | DATE 16/12/2016 | |  Regal Beloit America, Inc. |
| | APPROVED BY SBD | | |
| | DATE 16/12/2016 | | DESCRIPTION CONN DIAGRAM-NAMEPLATE |
| | REFERENCE | MATERIAL | PROCESS/FINISH |
| | THIRD ANGLE PROJECTION  | SIZE A | DRAWING NUMBER 8442000085 |

Model No. TCM0152A2113GAC011

| U (V) | Δ / Y Conn | f [Hz] | P | | I [A] | n [RPM] | T [Nm] | IE Class | % EFF at __ load | | | | PF at __ load | | | I_A/I_N [pu] | T_A/T_N [pu] | T_K/T_N [pu] |
|----------|----------------------|-----------|------|------|----------|------------|-----------|-------------|------------------|------|-------|-------|---------------|-------|-------|-------------------|-------------------|-------------------|
| | | | [kW] | [hp] | | | | | 5/4FL | FL | 3/4FL | 1/2FL | FL | 3/4FL | 1/2FL | | | |
| 400 | Δ | 50 | 15 | 20 | 27.7 | 1476 | 96.53 | IE3 | - | 92.1 | 92.1 | 91.6 | 0.85 | 0.8 | 0.69 | 7.6 | 2.7 | 3.4 |
| | | | | | | | | | | | | | | | | | | |

| | | | |
|----------------------------------|--------------------|---|--|
| Motor type | TCM | Degree of protection | IP 66 |
| Enclosure | TEFC | Mounting type | IM B3 |
| Frame Material | Cast Iron | Cooling method | IC 411 |
| Frame size | 160L | Motor weight - approx. | 180 kg |
| Duty | S1 | Gross weight - approx. | 200 kg |
| Voltage variation * | $\pm 10\%$ | Motor inertia | 0.1597 kgm ² |
| Frequency variation * | $\pm 5\%$ | Load inertia | Customer to Provide |
| Combined variation * | 10% | Vibration level | 2.2 mm/s |
| Design | N | Noise level (1meter distance from motor) | 64 dB(A) |
| Service factor | 1.15 | No. of starts hot/cold/Equally spread | 2/3/4 |
| Insulation class | H | Starting method | DOL |
| Ambient temperature | -20 to +40 °C | Type of coupling | Direct |
| Temperature rise (by resistance) | 80 [Class B] K | LR withstand time (hot/cold) | 10/20 s |
| Altitude above sea level | 1000 meter | Direction of rotation | Bi-directional |
| Hazardous area classification | NA | Standard rotation | Clockwise form DE |
| Zone classification | NA | Paint shade | RAL 2008 |
| Gas group | NA | Accessories | |
| Temperature class | NA | Accessory - 1 | PTC 150°C |
| Rotor type | Aluminum Die cast | Accessory - 2 | - |
| Bearing type | Anti-friction ball | Accessory - 3 | - |
| DE / NDE bearing | 6309-C3 / 6209-C3 | Terminal box position | RHS |
| Lubrication method | Greased for life | Maximum cable size/conduit size | 1R x 3C x 35mm ² /2 X M32 x 1.5 |
| Type of grease | NA | Auxiliary terminal box | YES |

 I_A/I_N - Locked Rotor Current / Rated Current T_K/T_N - Breakdown Torque / Rated Torque T_A/T_N - Locked Rotor Torque / Rated Torque**NOTE**

All performance values at rated voltage and frequency.

All performance parameters are subjected to standard tolerance as per IEC 60034-1

* Voltage, Frequency and combine variation are as per IEC60034-1

Technical data are subject to change. There may be slight variations between calculated values in this datasheet and the motor nameplate figures.

| Efficiency Standards | Europe IEC:60034-30-1 | China - | India - | Aus/Nz AS/NZ 1359:5:2004 | Brazil - | Global IEC IEC:60034-30-1 |
|----------------------|--------------------------|------------|------------|-----------------------------|-------------|------------------------------|
| | | | | | | |

Model No. TCM0152A2113GAC011

| Enclosure | U (V) | Δ / Y Conn | f [Hz] | P [kW] | P [hp] | I [A] | n [RPM] | T [kgm] | T [Nm] | IE Class | Amb [°C] | Duty | Elevation [m] | Inertia [kg-m ²] | Weight [kg] |
|-----------|-------|------------|--------|--------|--------|-------|---------|---------|--------|----------|----------|------|---------------|------------------------------|-------------|
| TEFC | 400 | Δ | 50 | 15 | 20.0 | 27.7 | 1476 | 9.84 | 96.53 | IE3 | 40 | S1 | 1000 | 0.1597 | 180 |

Motor Load Data

| Load Point | | NL | 1/4FL | 1/2FL | 3/4FL | FL | 5/4FL |
|--------------|-------|------|-------|-------|-------|------|-------|
| Current | A | 11.2 | 12.7 | 17.2 | 21.9 | 27.7 | |
| Torque | Nm | 0.0 | 23.8 | 47.9 | 72.1 | 96.5 | |
| Speed | r/min | 1500 | 1494 | 1488 | 1482 | 1476 | |
| Efficiency | % | 0.0 | 87.5 | 91.6 | 92.1 | 92.1 | |
| Power Factor | % | 6.3 | 48.4 | 69.0 | 80.0 | 85.0 | |

Performance vs Load Chart

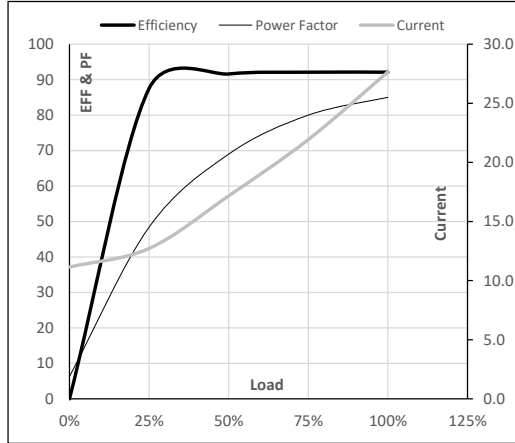

Motor Speed Torque Data

| Load Point | | LR | P-Up | BD | Rated | NL |
|------------|-------|-------|-------|-------|-------|------|
| Speed | r/min | 0 | 214 | 1312 | 1476 | 1500 |
| Current | A | 210.2 | 189.2 | 120.4 | 27.7 | 11.2 |
| Torque | pu | 2.7 | 2.3 | 3.4 | 1 | 0 |

Starting Characteristics Chart

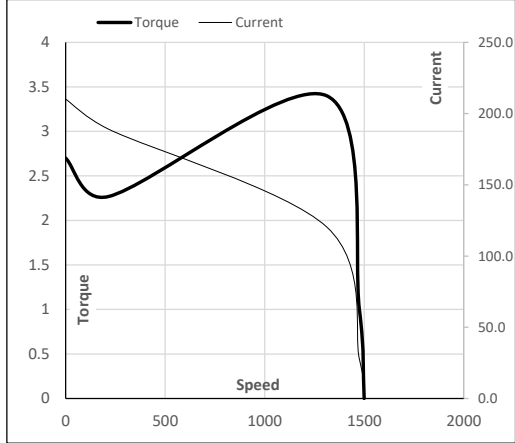

NOTE Refer data sheet for applicable standard and tolerances on performance parameters

Issued By
Issued Date



Model No. TCM0152A2113GAC011

| | | | | | | | | | | | | | | | |
|-----------|----------|---------------|-----------|-----------|-----------|----------|------------|------------|-----------|-------------|-------------|------|------------------|---------------------------------|----------------|
| Enclosure | U (V) | Δ / Y Conn | f [Hz] | P [kW] | P [hp] | I [A] | n [rpm] | T [kgm] | T [Nm] | IE Class | Amb [°C] | Duty | Elevation [m] | Inertia [kg-m ²] | Weight [kg] |
| TEFC | 400 | Δ | 50 | 15 | 20 | 27.7 | 1476 | 9.84 | 96.53 | IE3 | 40 | S1 | 1000 | 0.1597 | 180 |

Motor Speed Torque Data

| Load | FL | I ₁ | I ₂ | I ₃ | I ₄ | I ₅ | LR | |
|----------|---------|----------------|----------------|----------------|----------------|----------------|-----|-----|
| TWT Hot | s 10000 | 50 | 25 | 22 | 19 | 16 | 10 | |
| TWT Cold | s 10000 | 100 | 51 | 44 | 38 | 32 | 20 | |
| Current | pu | 1 | 2 | 3 | 4 | 5 | 5.5 | 7.6 |

Thermal Characteristics Chart

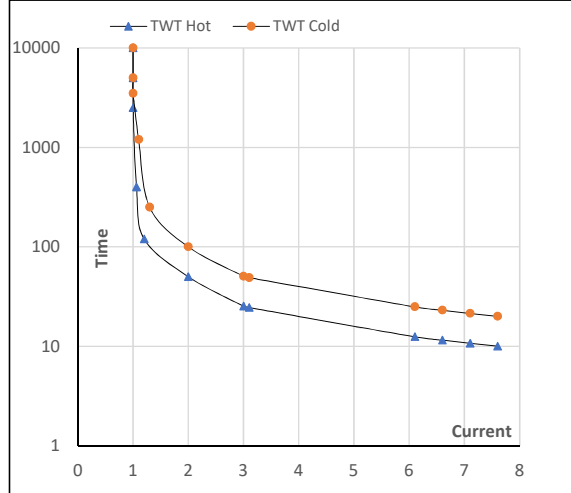

NOTE Refer data sheet for applicable standard and tolerances on performance parameters

Issued By
Issued Date

