

PRODUCT INFORMATION PACKET

marathon®
Motors

Model No: TCE0753A2121GAA001

Catalog No: TCE0753A2121GAA001

TerraMAX® Increased Safety Motors Ex eb, Totally Enclosed Fan Cooled, 100 HP, 3 Ph, 50 Hz, 400 V,
991 RPM, 315S Frame



Regal and Marathon are trademarks of Regal Rexnord Corporation or one of its affiliated companies.

©2022 Regal Rexnord Corporation, All Rights Reserved. MC017097E

RegalRexnord



Nameplate Specifications

Output HP	100 Hp	Output KW	75.0 kW
Frequency	50 Hz	Voltage	400 V
Current	142.1 A	Speed	991 rpm
Service Factor	1	Phase	3
Efficiency	94.6 %	Power Factor	0.8
Duty	S1	Insulation Class	F
Frame	315S	Enclosure	Totally Enclosed Fan Cooled
Thermal Protection	No Protection	Ambient Temperature	40 °C
Drive End Bearing Size	6319	Opp Drive End Bearing Size	6319
UL	No	CSA	No
CE	Yes	IP Code	IP55
Number of Speeds	3		

Technical Specifications

Electrical Type	Squirrel Cage	Starting Method	Direct On Line
Poles	6	Rotation	Bi-Directional
Mounting	B5	Motor Orientation	Horizontal
Drive End Bearing	2z-C3	Opp Drive End Bearing	2z-C3
Frame Material	Cast Iron	Shaft Type	Keyed
Overall Length	1206 mm	Frame Length	729 mm
Shaft Diameter	80.000 mm	Shaft Extension	170 mm
Assembly/Box Mounting	Top		
Connection Drawing	8442000085	Outline Drawing	0231500892

This is an uncontrolled document once printed or downloaded and is subject to change without notice. Date Created:12/02/2022

OUTLINE

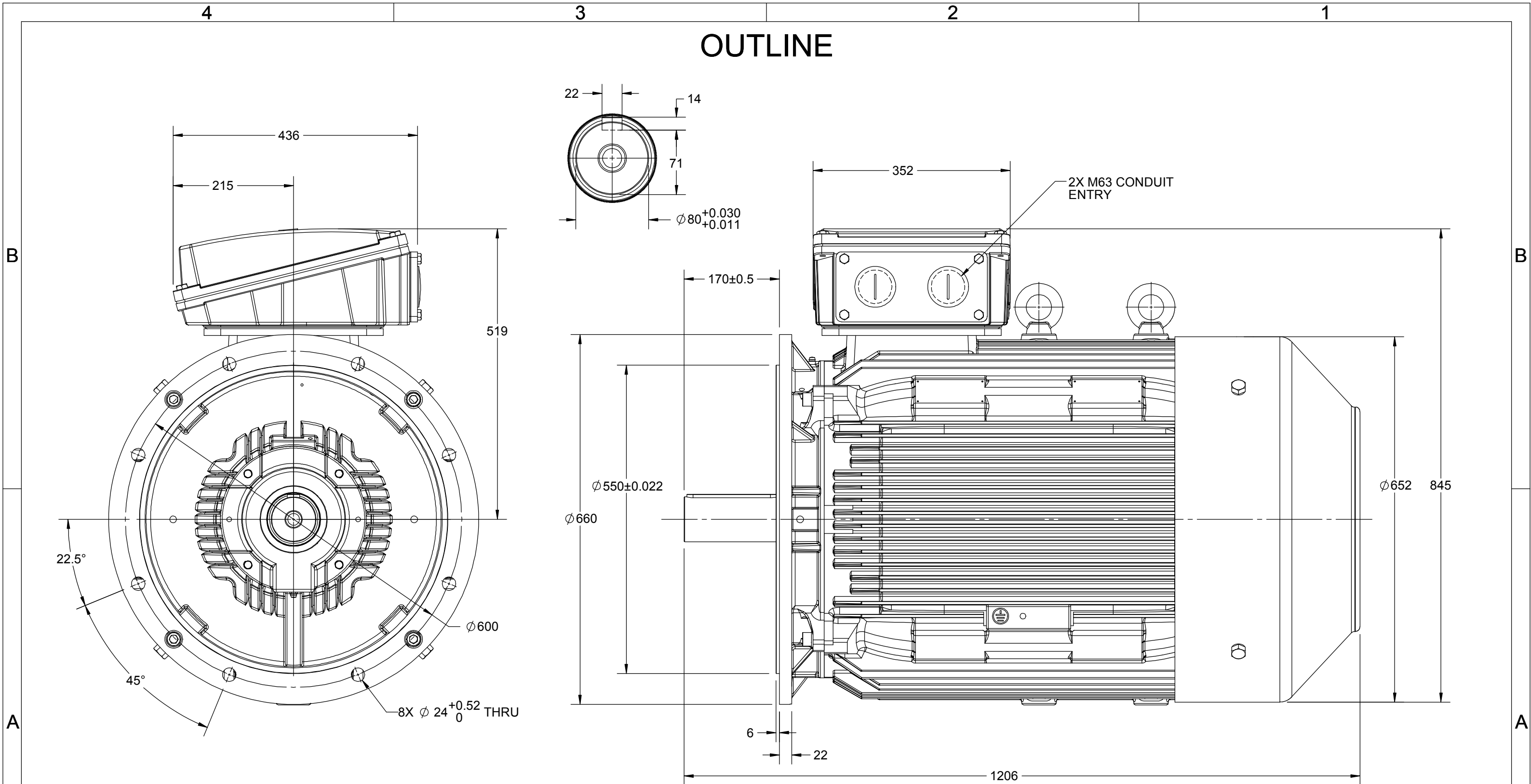

DRAWING REVISION B	REVISION BY NIV	DATE 14/05/2019
ECO ECO-0165600	APPROVED BY SR	DATE 14/05/2019
ECO DESCRIPTION MODEL UPDATED		
<small>COPYRIGHT REGAL BELOIT AMERICA, INC. ALL RIGHTS RESERVED. PROPRIETARY AND CONFIDENTIAL INFORMATION - THIS DOCUMENT IS THE PROPERTY OF REGAL BELOIT AMERICA, INC. ("OWNER") AND CONTAINS OWNER'S PROPRIETARY INFORMATION. ANY PERSON, CORPORATION OR OTHER FIRM RECEIVING IT IS DEEMED, BY RECEIVING IT, TO AGREE THAT IT, AND/OR ANY PART OF IT, SHALL NOT BE DISCLOSED TO ANY PERSON, CORPORATION OR OTHER ENTITY, DUPLICATED, AND/OR USED, EXCEPT AS EXPRESSLY APPROVED IN WRITING IN ADVANCE BY OWNER. THIS DOCUMENT SHALL BE RETURNED TO OWNER UPON REQUEST. IT MAY BE SUBJECT TO CERTAIN RESTRICTIONS UNDER APPLICABLE EXPORT CONTROL LAWS AND REGULATIONS.</small>		

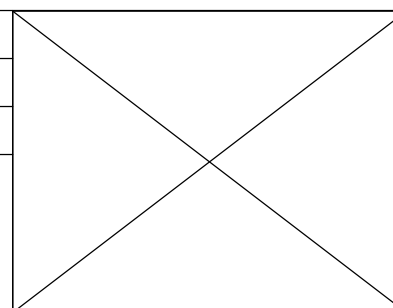

DRAWN BY JOY
DATE 18/07/2014
APPROVED BY SBD
DATE 18/07/2014
REFERENCE

marathon™ Motors	
DESCRIPTION OUTLINE 315M-B5 MTG. MOTOR TYPE: TCA	
MATERIAL	PROCESS/FINISH
SIZE B	DRAWING NUMBER 0231500892
SHEET 1 OF 1	

COPYRIGHT REGAL BELOIT AMERICA, INC. ALL RIGHTS RESERVED. UNAUTHORIZED REPRODUCTION OR DISTRIBUTION OF THIS DOCUMENT IS PROHIBITED. REGAL BELOIT AMERICA, INC. ("OWNER") AND CONTAINS OWNER'S PROPRIETARY INFORMATION. ANY PERSON, CORPORATION OR OTHER FIRM RECEIVING IT IS DEEMED, BY RECEIVING IT, TO AGREE THAT IT, AND/OR ANY PART OF IT, SHALL NOT BE DISCLOSED TO ANY PERSON, CORPORATION OR OTHER ENTITY, DUPLICATED, AND/OR USED, EXCEPT AS EXPRESSLY APPROVED IN WRITING IN ADVANCE BY OWNER. THIS DOCUMENT SHALL BE RETURNED TO OWNER UPON REQUEST. IT MAY BE SUBJECT TO CERTAIN RESTRICTIONS UNDER APPLICABLE EXPORT CONTROL LAWS AND REGULATIONS.

DRAWING REVISION A	REVISION BY SN	DATE 13/01/2017
ECO ECO-0116390	APPROVED BY SBD	DATE 13/01/2017
ECO DESCRIPTION NEW DRAWING RELEASE		

GEOMETRIC TOLERANCE		
LINEAR DIM	>0~6	±0.1
	>6~30	±0.2
	>30~120	±0.3

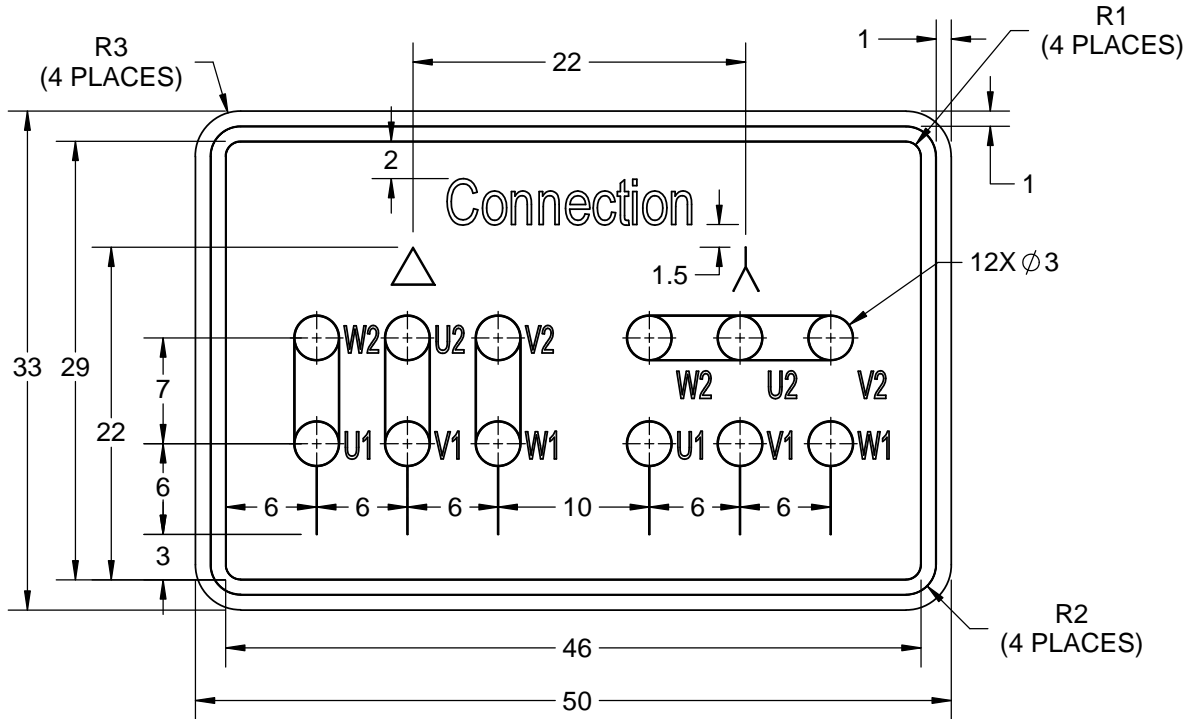



NOTES:

1. PRESSURE-SENSITIVE ADHESIVE COATED PAPER ON THE BACK OF SELF-ADHESIVE.
2. AT THE END OF YELLOW, WORDS, SYMBOLS, LETTERS ARE BLACK, BORDER IS BLACK.
3. THE TOLERANCE OF THE LINEAR SIZE OF THE TOLERANCE WITHOUT THE TOLERANCE BY THE TABLE.

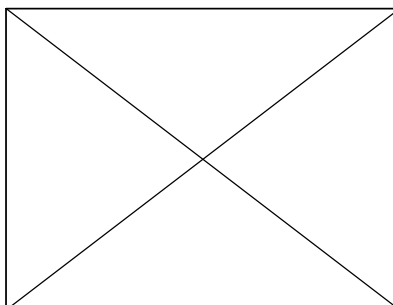
8WD.442.2017



DRAWN BY SN	DATE 16/12/2016		 Regal Beloit America, Inc.
	APPROVED BY SBD		
	DATE 16/12/2016		DESCRIPTION CONN DIAGRAM-NAMEPLATE
	REFERENCE	MATERIAL	PROCESS/FINISH
	THIRD ANGLE PROJECTION 	SIZE A	DRAWING NUMBER 8442000085

Model No. TCE0753A2121GAA001

U (V)	Δ / Y Conn	f [Hz]	P		I [A]	n [RPM]	T [Nm]	IE Class	% EFF at __ load				PF at __ load			I_A/I_N [pu]	T_A/T_N [pu]	T_K/T_N [pu]
			[kW]	[hp]					5/4FL	FL	3/4FL	1/2FL	FL	3/4FL	1/2FL			
400	Δ	50	75	100.0	142.1	991	718.58	IE3	-	94.6	94.6	94.4	0.81	0.76	0.64	5.9	1.9	2.5

Motor type	TCE	Degree of protection	IP 55
Enclosure	TEFC	Mounting type	IM B5
Frame Material	Cast Iron	Cooling method	IC 411
Frame size	315S	Motor weight - approx.	887 kg
Duty	S1	Gross weight - approx.	932 kg
Voltage variation *	$\pm 10\%$	Motor inertia	3.9975 kgm ²
Frequency variation *	$\pm 5\%$	Load inertia	Customer to Provide
Combined variation *	10%	Vibration level	2.8 mm/s
Design	N	Noise level (1meter distance from motor)	66 dB(A)
Service factor	1.0	No. of starts hot/cold/Equally spread	2/3/4
Insulation class	F	Starting method	DOL
Ambient temperature	-15 to +40 °C	Type of coupling	Direct
Temperature rise (by resistance)	70 [Class B] K	tE time	20 s
Altitude above sea level	1000 meter	Direction of rotation	Bi-directional
Hazardous area classification	Ex eb	Standard rotation	Clockwise form DE
Zone classification	Zone 2	Paint shade	RAL 7016
Gas group	IIC	Accessories	
Temperature class	T3	Accessory - 1	PTC 150°C
Rotor type	Aluminum Die cast	Accessory - 2	-
Bearing type	Anti-friction ball	Accessory - 3	-
DE / NDE bearing	6319 C3 / 6319 C3	Terminal box position	TOP
Lubrication method	Regreasable	Maximum cable size/conduit size	1R x 3C x 240mm ² /2 x M63 x 1.5
Type of grease	CHEVRON SRI-2 or Equivalent	Auxiliary terminal box	NA

I_A/I_N - Locked Rotor Current / Rated Current

T_K/T_N - Breakdown Torque / Rated Torque

T_A/T_N - Locked Rotor Torque / Rated Torque

NOTE

ATEX/IEC Ex certified as per IEC/EN 60079-0; IEC/EN 60079-7

All performance values at rated voltage and frequency.

All performance parameters are subjected to standard tolerance as per IEC 60034-1

* Voltage, Frequency and combined variation are as per IEC60034-1

Technical data are subject to change. There may be slight variations between calculated values in this datasheet and the motor nameplate figures.

Efficiency Standards	Europe	China	India	Aus/Nz	Brazil	Global IEC
	IEC:60034-30-1		-	-	-	IEC:60034-30-1

Model No. TCE0753A2121GAA001

Enclosure	U (V)	Δ / Y Conn	f [Hz]	P [kW]	P [hp]	I [A]	n [RPM]	T [kgm]	T [Nm]	IE Class	Amb [°C]	Duty	Elevation [m]	Inertia [kg-m ²]	Weight [kg]
TEFC	400	Δ	50	75	100	142.1	991	73.28	718.58	IE3	40	S1	1000	3.9975	887

Motor Load Data

Load Point		NL	1/4FL	1/2FL	3/4FL	FL	5/4FL
Current	A	58.2	65.8	88.6	112.4	142.1	
Torque	Nm	0.0	242.0	484.9	729.0	718.6	
Speed	r/min	1000	998	996	994	991	
Efficiency	%	0.0	91.2	94.4	94.6	94.6	
Power Factor	%	4.1	44.9	64.4	75.6	80.5	

Performance vs Load Chart

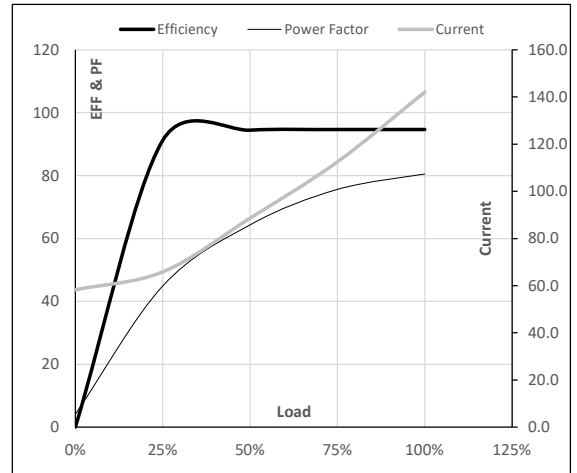

Motor Speed Torque Data

Load Point		LR	P-Up	BD	Rated	NL
Speed	r/min	0	143	912	991	1000
Current	A	838.4	754.6	456.4	142.1	58.2
Torque	pu	1.9	1.6	2.5	1	0

Starting Characteristics Chart

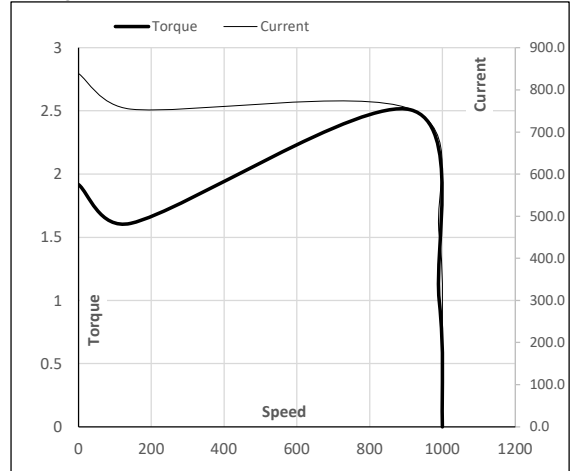

NOTE Refer data sheet for applicable standard and tolerances on performance parameters

Issued By
Issued Date

