

# PRODUCT INFORMATION PACKET

Model No: TCA5P52AE271GAA009

Catalog No: R628

Cast Iron Motor, 7.50 & 5.50 HP, 3 Ph, 60 & 50 Hz, 230/460 & 200/400 V, 1800 & 1500 RPM,  
132S Frame, TEFC



Regal and Marathon are trademarks of Regal Rexnord Corporation or one of its affiliated companies.

©2023 Regal Rexnord Corporation, All Rights Reserved. MC017097E

### Nameplate Specifications

Phase	<b>3</b>	Output HP	<b>7.50 &amp; 5.50 Hp</b>
Output KW	<b>5.5 &amp; 4.0 kW</b>	Voltage	<b>230/460 &amp; 200/400 V</b>
Speed	<b>1775 &amp; 1480 rpm</b>	Service Factor	<b>1.15 &amp; 1.15</b>
Frame	<b>132S</b>	Enclosure	<b>Totally Enclosed Fan Cooled</b>
Thermal Protection	<b>No Protection</b>	Efficiency	<b>91.7 &amp; 88.6 %</b>
Ambient Temperature	<b>40 °C</b>	Frequency	<b>60 &amp; 50 Hz</b>
Current	<b>19.6/9.8 &amp; 17.6/8.8 A</b>	Power Factor	<b>77</b>
Duty	<b>Continuous</b>	Insulation Class	<b>F</b>
Design Code	<b>N (IEC)</b>	KVA Code	<b>J</b>
Drive End Bearing Size	<b>6308</b>	Opp Drive End Bearing Size	<b>6208</b>
UL	<b>Recognized</b>	CSA	<b>N</b>
CE	<b>Y</b>	IP Code	<b>55</b>
Number of Speeds	<b>1</b>	Efficiency Class	<b>IE3</b>

### Technical Specifications

Electrical Type	<b>Squirrel Cage Inverter Rated</b>	Starting Method	<b>Line Or Inverter</b>
Poles	<b>4</b>	Rotation	<b>Reversible</b>
Resistance Main	<b>1.56 Ohms</b>	Mounting	<b>Round</b>
Motor Orientation	<b>Horizontal</b>	Drive End Bearing	<b>Ball</b>
Opp Drive End Bearing	<b>Ball</b>	Frame Material	<b>Cast Iron</b>
Shaft Type	<b>IEC</b>	Overall Length	<b>18.31 in</b>
Frame Length	<b>7.95 in</b>	Shaft Diameter	<b>1.496 in</b>
Shaft Extension	<b>3.15 in</b>	Assembly/Box Mounting	<b>F3</b>
Inverter Load	<b>CONSTANT 2:1/VARIABLE 10:1</b>		
Outline Drawing	<b>SS620900</b>	Connection Drawing	<b>8442000715</b>



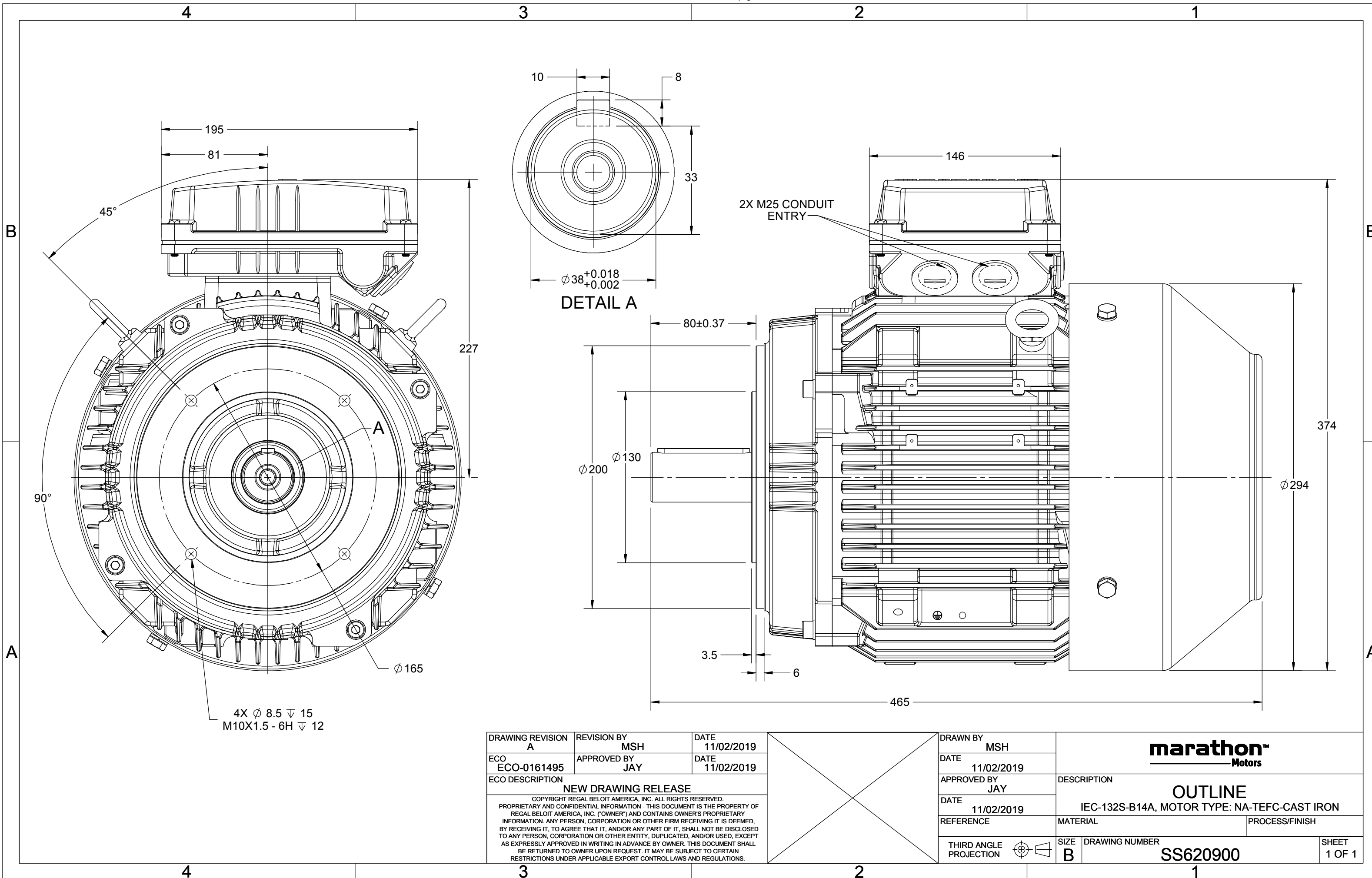

DRAWING REVISION A	REVISION BY MSH	DATE 11/02/2019
ECO ECO-0161495	APPROVED BY JAY	DATE 11/02/2019
ECO DESCRIPTION <b>NEW DRAWING RELEASE</b> COPYRIGHT REGAL BELOIT AMERICA, INC. ALL RIGHTS RESERVED. PROPRIETARY AND CONFIDENTIAL INFORMATION - THIS DOCUMENT IS THE PROPERTY OF REGAL BELOIT AMERICA, INC. ("OWNER") AND CONTAINS OWNER'S PROPRIETARY INFORMATION. ANY PERSON, CORPORATION OR OTHER FIRM RECEIVING IT IS DEEMED, BY RECEIVING IT, TO AGREE THAT IT, AND/OR ANY PART OF IT, SHALL NOT BE DISCLOSED TO ANY PERSON, CORPORATION OR OTHER ENTITY, DUPLICATED, AND/OR USED, EXCEPT AS EXPRESSLY APPROVED IN WRITING IN ADVANCE BY OWNER. THIS DOCUMENT SHALL BE RETURNED TO OWNER UPON REQUEST. IT MAY BE SUBJECT TO CERTAIN RESTRICTIONS UNDER APPLICABLE EXPORT CONTROL LAWS AND REGULATIONS.		

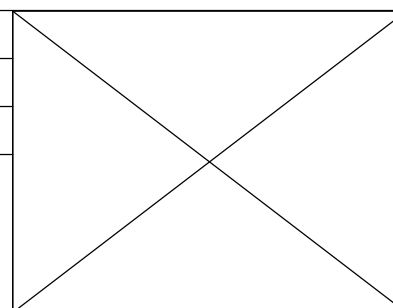

DRAWN BY MSH
DATE 11/02/2019
APPROVED BY JAY
DATE 11/02/2019
REFERENCE
THIRD ANGLE PROJECTION

<b>marathon™ Motors</b>	
<b>OUTLINE</b>	
IEC-132S-B14A, MOTOR TYPE: NA-TEFC-CAST IRON	
MATERIAL	PROCESS/FINISH
SIZE B	DRAWING NUMBER SS620900
SHEET 1 OF 1	

COPYRIGHT REGAL BELOIT AMERICA, INC. ALL RIGHTS RESERVED.  
 PROPRIETARY AND CONFIDENTIAL INFORMATION - THIS DOCUMENT IS THE PROPERTY OF  
 REGAL BELOIT AMERICA, INC. ("OWNER") AND CONTAINS OWNER'S PROPRIETARY  
 INFORMATION. ANY PERSON, CORPORATION OR OTHER FIRM RECEIVING IT IS DEEMED,  
 BY RECEIVING IT, TO AGREE THAT IT, AND/OR ANY PART OF IT, SHALL NOT BE DISCLOSED  
 TO ANY PERSON, CORPORATION OR OTHER ENTITY, DUPLICATED, AND/OR USED, EXCEPT  
 AS EXPRESSLY APPROVED IN WRITING IN ADVANCE BY OWNER. THIS DOCUMENT SHALL  
 BE RETURNED TO OWNER UPON REQUEST. IT MAY BE SUBJECT TO CERTAIN  
 RESTRICTIONS UNDER APPLICABLE EXPORT CONTROL LAWS AND REGULATIONS.

DRAWING REVISION <b>A</b>	REVISION BY <b>S.MUDDA</b>	DATE <b>16/11/2020</b>
ECO <b>ECO-0194685</b>	APPROVED BY <b>SUMANTA</b>	DATE <b>16/11/2020</b>
ECO DESCRIPTION <b>NEW DRAWING</b>		

GEOMETRIC TOLERANCE		
LINEAR DIM	>0~6	±0.1
	>6~30	±0.2
	>30~120	±0.3

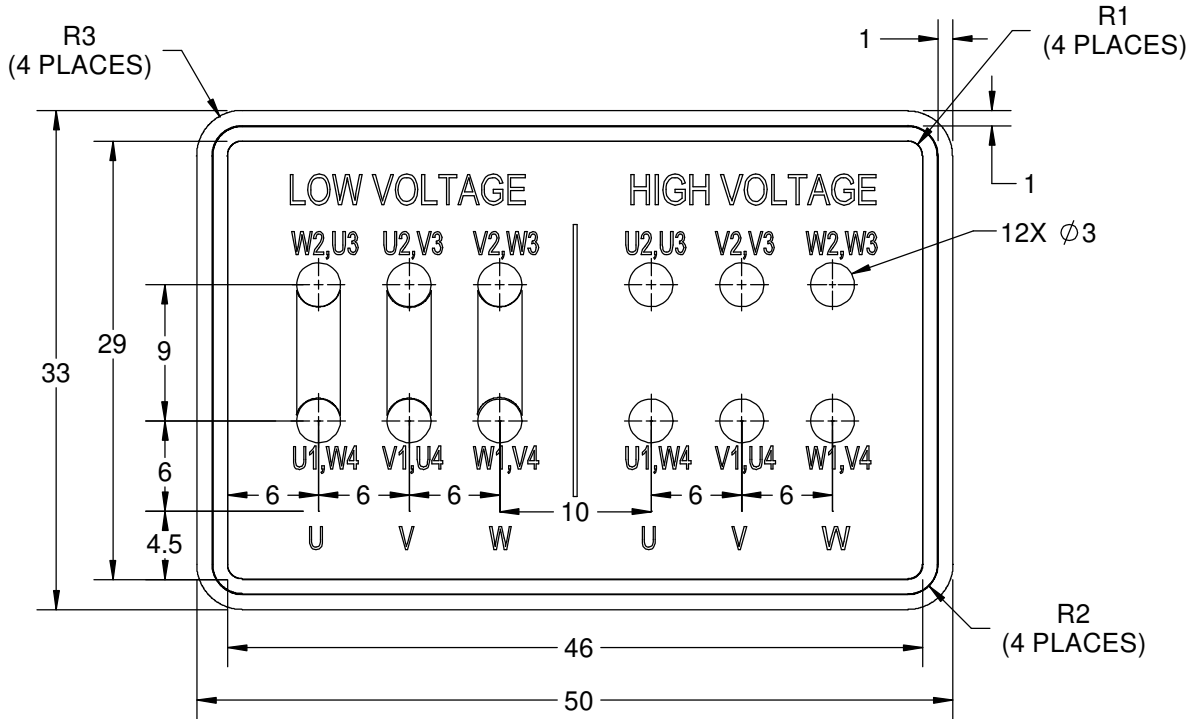



**NOTES:**

1. PRESSURE-SENSITIVE ADHESIVE COATED PAPER ON THE BACK OF SELF-ADHESIVE.
2. AT THE END OF YELLOW, WORDS, SYMBOLS, LETTERS ARE BLACK, BORDER IS BLACK.
3. THE TOLERANCE OF THE LINEAR SIZE OF THE TOLERANCE WITHOUT THE TOLERANCE BY THE TABLE.
4. LEAD TERMINAL MARKINGS FONT SIZE : T1-T12 & U1-U4,V1-V4& W1-W4 OF ARIAL WITH 3mm SIZE
5. OTHER LETTER FONT SIZE SHOULD BE 3.5mm.

8WD.442.2017



DRAWN BY <b>S.MUDDA</b>	DATE <b>16/11/2020</b>	 <b>Regal Beloit America, Inc.</b>		
	APPROVED BY <b>SUMANTA</b>		DESCRIPTION <b>CONN DIAGRAM-NAMEPLATE</b>	
	DATE <b>16/11/2020</b>	MATERIAL	PROCESS/FINISH	
	REFERENCE	SIZE <b>A</b>	DRAWING NUMBER <b>8442000715</b>	SHEET <b>1 OF 1</b>
	THIRD ANGLE PROJECTION 			



P.O. BOX 8003  
WAUSAU, WI 54401-8003  
PH. 715-675-3311

DATA VOLTS: 460

**CERTIFICATION DATA SHEET**

CUSTOMER: \_\_\_\_\_  
ORDER #: \_\_\_\_\_  
CONN. DIAGRAM: 8442000677  
OUTLINE: SS620900  
WINDING: IE3L1324201 NONE 1  
SPEED: \_\_\_\_\_

CUSTOMER P.O. #: \_\_\_\_\_  
REFERENCE MODEL #: TCA5P52AE271GAA009  
CAT #: R628  
CUSTOMER PART #: \_\_\_\_\_  
MOUNTING: F3

**TYPICAL MOTOR PERFORMANCE DATA**

HP	KW	SYNC RPM	FL RPM	FRAME	ENCLOSURE	TYPE	KVA CODE	DESIGN
7.5	5.6	1800	1775	132S	TEFC	TCA 132SA04	J	N

PH	HZ	VOLTS	AMPS	START TYPE	DUTY	INSL	S.F.	AMB (° C)	ELEV.(Ft.)
3	60/50	230/460#200/400	19.6/9.8&17.6/8.8	LINE OR INVERTER	CONT	F	1.15	40	3300

F.L. EFF	91.7	3/4 LD EFF	91.7	1/2 LD EFF	90.3	GTD EFF	ELECT. TYPE
F.L. PF	77.0	3/4 LD PF	69.0	1/2 LD PF	57.0	90.5	SQ CAGE INV RATED

F.L. TORQUE	LR AMPS @ 460 V	L.R. TORQUE	B.D. TORQUE	F.L. RISE (° C)
22.2 LB-FT	73.4	54.2 LB-FT 244%	71.3 LB-FT 321%	75

SOUND PRESSURE @ 3 FT.	SOUND POWER	ROTOR WK <sup>2</sup>	MAX. LOAD WK <sup>2</sup>	SAFE STALL TIME	STARTS/HOUR	APROX. MOTOR WGT
65 dBA	74 dBA	1.10 LB-FT <sup>2</sup>	1.1 LB-FT <sup>2</sup>	10 SEC.	2	93 KG.

**\*\*\* SUPPLEMENTAL INFORMATION \*\*\***

DE BRACKET TYPE	ODE BRACKET TYPE	MOUNT TYPE	MOTOR ORIENTATION	SEVERE DUTY	HAZARDOUS LOCATION	DRIP COVER	SCREENS	PAINT
FT-FLANGE-165	STANDARD	ROUND	HORIZONTAL	NO	NONE	NO	NONE	BLUE (ENAMEL)

BEARINGS		GREASE	SHAFT TYPE	SPECIAL DE	SPECIAL ODE	SHAFT MATERIAL	FRAME MATERIAL
DE BALL	ODE BALL	POLYREX EM	STANDARD IEC	NONE	NONE	1045 HOT ROLLED (C-204)	CAST IRON
6308	6208						

THERMOSTATS	PROTECTORS	WDG RTD's	BRG RTD's	THERMISTORS	CONTROL	SPACE HEATERS
NONE	NOT	NONE	NONE	NONE	FALSE	NA

R1 (ohms/ph)	R2 (ohms/ph)	X1 (ohms/ph)	X2 (ohms/ph)	Xm (ohms/ph)	VIBRATION (in/sec)	FLOAT
0.908	0.454	2.004	2.572	49.242	0.150	ODE

* N O T E S *	INVERTER TORQUE: CONSTANT 2:1/VARIABLE 10:1 INV. HP SPEED RANGE: NONE					
	ENCODER: NONE					
	NONE					
	NONE PPR					
	BRAKE: NONE					

PREPARED BY: _____	BRAKE: NONE
DATE: 11/16/2020	NONE NONE
	FT-LB: NA
	VOLTAGE: NONE HZ:
FORM: 3531 REV_4 2/27/06	UL: V - LI,ME-INS,CONST UL REC



Data Sheet

TCA5P52AE271GAA009

Date: 5/30/2019  
Customer:  
Attention:

Submittal

Submitted by: Fareeda Dudekula

Data @ 460 V

Motor Load Data

Load	0%	25%	50%	75%	100%	115%	125%	LR
Current (Amps)	5.2	6.1	6.8	8.3	9.8	11.1	11.9	73.4
Torque (ft-lb)	0.00	5.5	11.0	16.6	22.2	25.6	27.9	54.2
RPM	1800	1794	1788	1781	1775	1,770	1767	0
Efficiency (%)		85.0	90.3	91.7	91.7	91.0	90.7	
P.F. (%)	6.0	34.0	57.0	69.0	77.0	80.0	81.0	63.4

Motor Speed Data

	LR	Pull-Up	BD	Rated	Idle
Speed (RPM)	0	600	1587	1775	1800
Current (Amps)	73.4	69.8	42.7	9.8	5.2
Torque (ft-lb)	54.2	51.5	71.3	22.2	0.00

Information Block				
HP	7.5			
Sync. RPM	1800			
Frame	132			
Enclosure	TEFC			
Construction	TCA 132S04			
Voltage	230/460#200/400 V			
Frequency	60 Hz			
Design	N			
LR Code letter	J			
Service Factor	1.15			
Temp Rise @ FL	80 °C			
Duty	CONT			
Ambient	40 °C			
Elevation	3,300 feet			
Rotor/Shaft wk <sup>2</sup>	1.10 Lb-Ft <sup>2</sup>			
Ref Wdg	IE3L1324201 NONE			
Sound Pressure @ 1M	65 dBA			
VFD Rating	CONSTANT 2:1/VARIABLE 10:1			
Outline Dwg	SS620900			
Conn. Diag	8442000677			
Additional Specifications:				
0				
0				
EQUIV CKT (OHMS / PHASE)				
R1	R2	X1	X2	Xm
0.9080	0.4540	2.0040	2.5720	49.2420

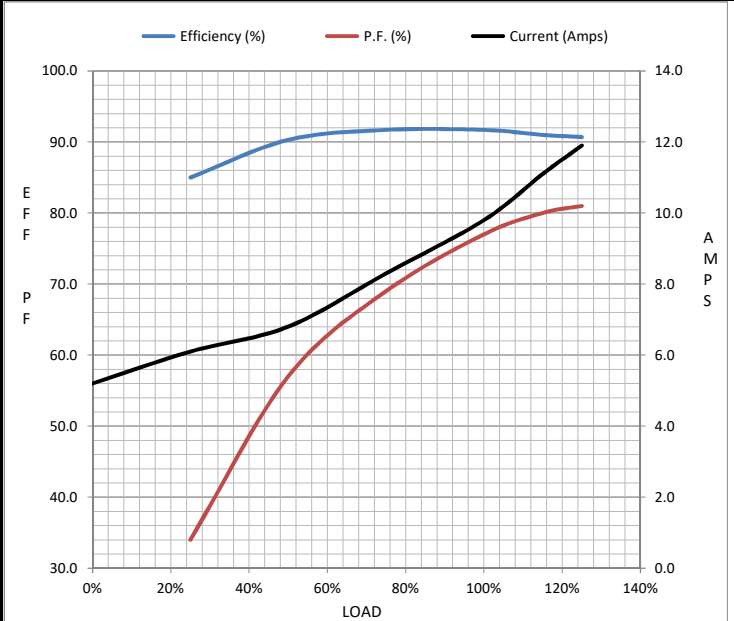

Speed - Torque Curve

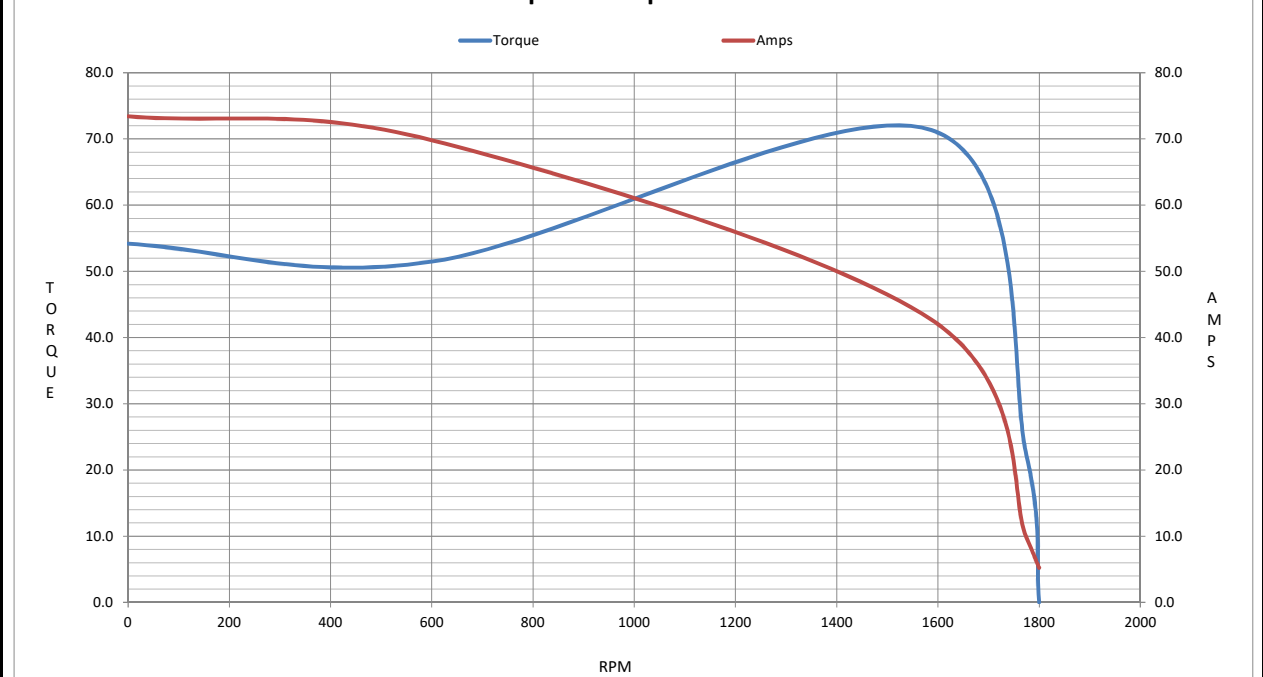

IEC

IEC

IEC

## EC Declaration of Conformity

The undersigned representing  
the manufacturer:

Regal Beloit America  
100 East Randolph St.  
Wausau, WI 54401

and the authorized representative  
established within the Community:

Marathon Electric UK  
6F Thistleton Road Ind. Estate  
Market Overton  
Oakham, Rutland LE15 7PP UK

are committed to providing customers with products that comply with applicable regulations and international protocols to which they are subject, including the requirements of the European Parliament Directive on the Harmonization of the laws relating to electrical equipment designed for use within certain voltage limits (2014/35/EU).

Regal Beloit America declares that the following product(s), to which this declaration relates, are in conformity with the relevant sections of the EC standards listed below.

This statement supersedes any statements previously issued pertaining to the product(s) listed below and is subject to change without notice.

Model No : TCA5P52AE271GAA009

(Model No. may contain prefix and/or suffix characters)

Catalog No : R628

Rework No : N/A

Directives :

Low Voltage Directive 2014/35/EU

Harmonized Standards Used :

EN 60034-1: 2010 (IEC 60034-1: 2010)

EN 60034-5: 2001/A1:2007 (IEC 60034-5: 2000/A1:2006)

Authorized Representative:



Michael A. Logsdon  
Vice President, Technology

Authorized Representative in the Community:



Julian Clark  
Marketing Engineer

Created on 09/01/2022

**CE 22**