

PRODUCT INFORMATION PACKET

marathon®
Motors

Model No: TCA0453AE211GAA009

Catalog No: R502A

Cast Iron Motor, 60 & 50 HP, 3 Ph, 60 & 50 Hz, 230/460 & 200/400 V, 1200 & 1000 RPM, 280S Frame,
TEFC



Regal and Marathon are trademarks of Regal Rexnord Corporation or one of its affiliated companies.

©2023 Regal Rexnord Corporation, All Rights Reserved. MC017097E

RegalRexnord

Nameplate Specifications

Phase	3	Output HP	60 & 50 Hp
Output KW	45.0 & 37.0 kW	Voltage	230/460 & 200/400 V
Speed	1190 & 990 rpm	Service Factor	1.15 & 1.15
Frame	280S	Enclosure	Totally Enclosed Fan Cooled
Thermal Protection	No Protection	Efficiency	94.5 & 93.3 %
Ambient Temperature	40 °C	Frequency	60 & 50 Hz
Current	146/73 & 142/71 A	Power Factor	82
Duty	Continuous	Insulation Class	F
Design Code	N (IEC)	KVA Code	H
Drive End Bearing Size	6317	Opp Drive End Bearing Size	6317
UL	Recognized	CSA	N
CE	Y	IP Code	55
Number of Speeds	1	Efficiency Class	IE3

Technical Specifications

Electrical Type	Squirrel Cage Inverter Rated	Starting Method	Line Or Inverter
Poles	6	Rotation	Reversible
Resistance Main	.08 Ohms	Mounting	B3
Motor Orientation	Horizontal	Drive End Bearing	Ball
Opp Drive End Bearing	Ball	Frame Material	Cast Iron
Shaft Type	IEC	Overall Length	41.73 in
Frame Length	21.61 in	Shaft Diameter	2.559 in
Shaft Extension	5.51 in	Assembly/Box Mounting	F3
Inverter Load	CONSTANT 2:1/VARIABLE 10:1		
Outline Drawing	SS557726	Connection Drawing	8442000715

OUTLINE

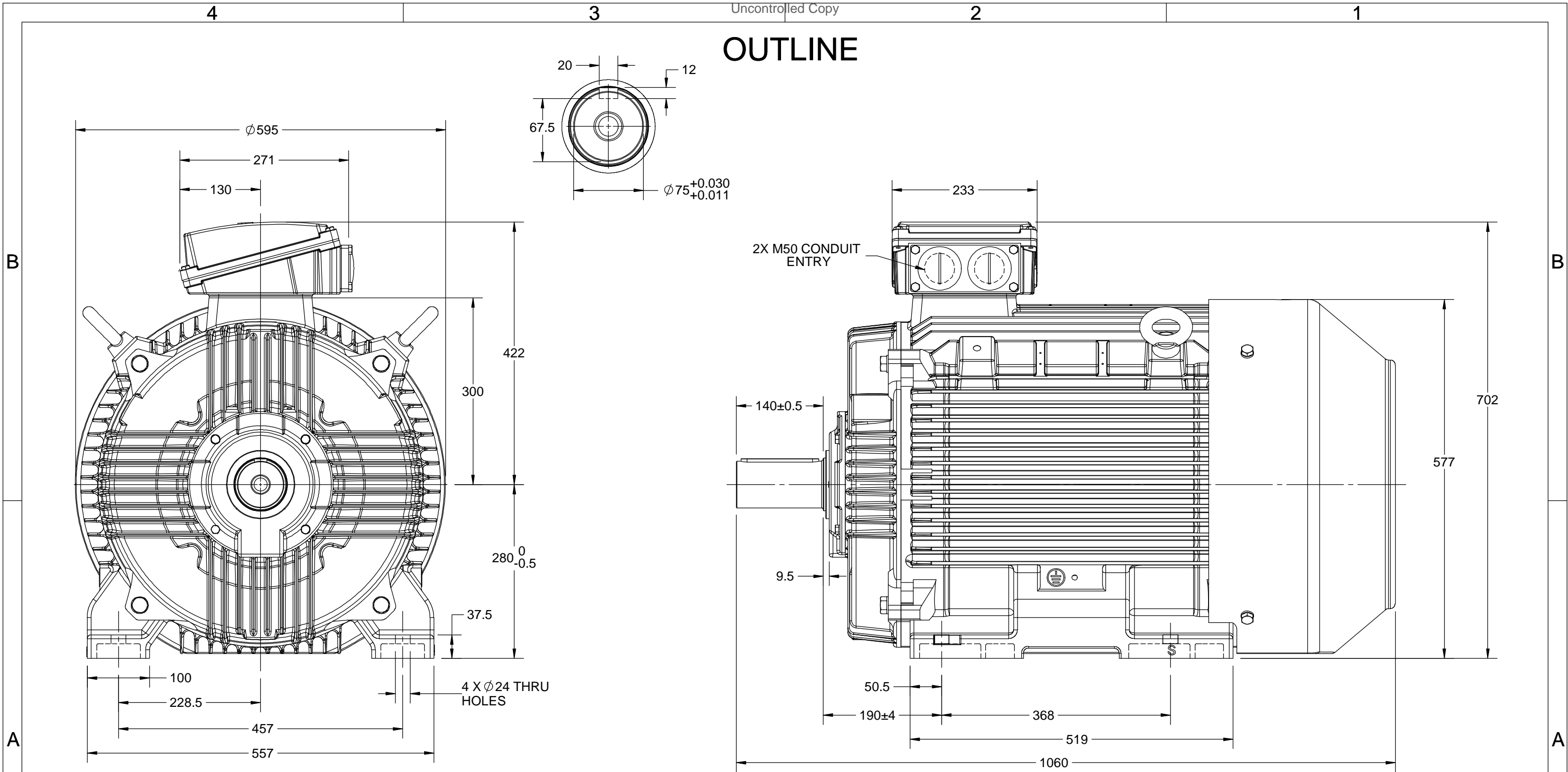

DRAWING REVISION A	REVISION BY LK	DATE 05/12/2018
ECO ECO-0157830	APPROVED BY JAY	DATE 05/12/2018
ECO DESCRIPTION NEW DRAWING RELEASE COPYRIGHT REGAL BELOIT AMERICA, INC. ALL RIGHTS RESERVED. PROPRIETARY AND CONFIDENTIAL INFORMATION - THIS DOCUMENT IS THE PROPERTY OF REGAL BELOIT AMERICA, INC. ("OWNER") AND CONTAINS OWNER'S PROPRIETARY INFORMATION. ANY PERSON, CORPORATION OR OTHER FIRM RECEIVING IT IS DEEMED, BY RECEIVING IT, TO AGREE THAT IT, AND/OR ANY PART OF IT, SHALL NOT BE DISCLOSED TO ANY PERSON, CORPORATION OR OTHER ENTITY, DUPLICATED, AND/OR USED, EXCEPT AS EXPRESSLY APPROVED IN WRITING IN ADVANCE BY OWNER. THIS DOCUMENT SHALL BE RETURNED TO OWNER UPON REQUEST. IT MAY BE SUBJECT TO CERTAIN RESTRICTIONS UNDER APPLICABLE EXPORT CONTROL LAWS AND REGULATIONS.		

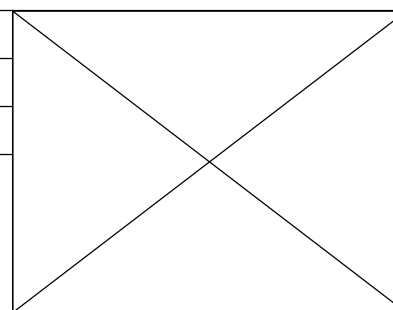

DRAWN BY LK	marathon™ Motors	
DATE 05/12/2018		
APPROVED BY JAY	DESCRIPTION OUTLINE	
DATE 05/12/2018	IEC-280S-4P-B3 MOTOR TYPE: TEFC-CAST IRON	
REFERENCE	MATERIAL	PROCESS/FINISH
THIRD ANGLE PROJECTION	SIZE B	DRAWING NUMBER SS557726
		SHEET 1 OF 1

COPYRIGHT REGAL BELOIT AMERICA, INC. ALL RIGHTS RESERVED.
 PROPRIETARY AND CONFIDENTIAL INFORMATION - THIS DOCUMENT IS THE PROPERTY OF
 REGAL BELOIT AMERICA, INC. ("OWNER") AND CONTAINS OWNER'S PROPRIETARY
 INFORMATION. ANY PERSON, CORPORATION OR OTHER FIRM RECEIVING IT IS DEEMED,
 BY RECEIVING IT, TO AGREE THAT IT, AND/OR ANY PART OF IT, SHALL NOT BE DISCLOSED
 TO ANY PERSON, CORPORATION OR OTHER ENTITY, DUPLICATED, AND/OR USED, EXCEPT
 AS EXPRESSLY APPROVED IN WRITING IN ADVANCE BY OWNER. THIS DOCUMENT SHALL
 BE RETURNED TO OWNER UPON REQUEST. IT MAY BE SUBJECT TO CERTAIN
 RESTRICTIONS UNDER APPLICABLE EXPORT CONTROL LAWS AND REGULATIONS.

DRAWING REVISION A	REVISION BY S.MUDDA	DATE 16/11/2020
ECO ECO-0194685	APPROVED BY SUMANTA	DATE 16/11/2020
ECO DESCRIPTION NEW DRAWING		

GEOMETRIC TOLERANCE		
LINEAR DIM	>0~6	±0.1
	>6~30	±0.2
	>30~120	±0.3

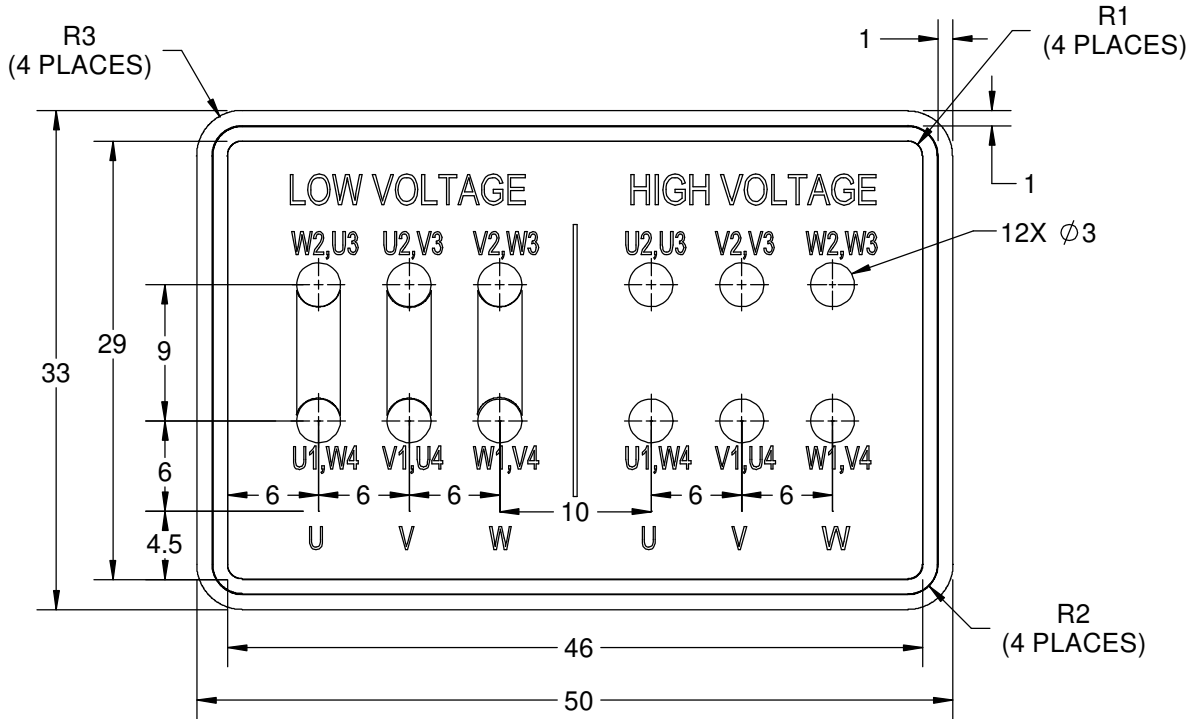



NOTES:

1. PRESSURE-SENSITIVE ADHESIVE COATED PAPER ON THE BACK OF SELF-ADHESIVE.
2. AT THE END OF YELLOW, WORDS, SYMBOLS, LETTERS ARE BLACK, BORDER IS BLACK.
3. THE TOLERANCE OF THE LINEAR SIZE OF THE TOLERANCE WITHOUT THE TOLERANCE BY THE TABLE.
4. LEAD TERMINAL MARKINGS FONT SIZE : T1-T12 & U1-U4,V1-V4& W1-W4 OF ARIAL WITH 3mm SIZE
5. OTHER LETTER FONT SIZE SHOULD BE 3.5mm.

8WD.442.2017



DRAWN BY S.MUDDA	DATE 16/11/2020	 Regal Beloit America, Inc.		
	APPROVED BY SUMANTA		DESCRIPTION CONN DIAGRAM-NAMEPLATE	
	DATE 16/11/2020	MATERIAL	PROCESS/FINISH	
	REFERENCE	SIZE A	DRAWING NUMBER 8442000715	SHEET 1 OF 1
	THIRD ANGLE PROJECTION 			



P.O. BOX 8003
WAUSAU, WI 54401-8003
PH. 715-675-3311

DATA VOLTS: 460

CERTIFICATION DATA SHEET

CUSTOMER: _____
ORDER #: _____
CONN. DIAGRAM: 8442000677
OUTLINE: SS557726
WINDING: IE3L2806201 NONE 1
SPEED: _____

CUSTOMER P.O. #: _____
REFERENCE MODEL #: TCA0453AE211GAA009
CAT #: R502B
CUSTOMER PART #: _____
MOUNTING: F3

TYPICAL MOTOR PERFORMANCE DATA

HP	KW	SYNC RPM	FL RPM	FRAME	ENCLOSURE	TYPE	KVA CODE	DESIGN
60	45	1200	1190	280S	TEFC	TCA 280SA06	H	N

PH	HZ	VOLTS	AMPS	START TYPE	DUTY	INSL	S.F.	AMB (° C)	ELEV.(Ft.)
3	60/50	230/460#200/400	146/73&142/71	LINE OR INVERTER	CONT	F	1.15	40	3300

F.L. EFF	94.5	3/4 LD EFF	94.5	1/2 LD EFF	92.4	GTD EFF	ELECT. TYPE
F.L. PF	82.0	3/4 LD PF	77.0	1/2 LD PF	68.0	93.7	SQ CAGE INV RATED

F.L. TORQUE	LR AMPS @ 460 V	L.R. TORQUE	B.D. TORQUE	F.L. RISE (° C)
265 LB-FT	483	494 LB-FT 186%	702 LB-FT 265%	80

SOUND PRESSURE @ 3 FT.	SOUND POWER	ROTOR WK ²	MAX. LOAD WK ²	SAFE STALL TIME	STARTS/HOUR	APROX. MOTOR WGT
68 dBA	77 dBA	53.2 LB-FT ²	53.2 LB-FT ²	15 SEC.	2	638 KG.

***** SUPPLEMENTAL INFORMATION *****

DE BRACKET TYPE	ODE BRACKET TYPE	MOUNT TYPE	MOTOR ORIENTATION	SEVERE DUTY	HAZARDOUS LOCATION	DRIP COVER	SCREENS	PAIN
STANDARD	STANDARD	B3	HORIZONTAL	NO	NONE	NO	NONE	BLUE (ENAMEL)

BEARINGS		GREASE	SHAFT TYPE	SPECIAL DE	SPECIAL ODE	SHAFT MATERIAL	FRAME MATERIAL
DE	ODE	SG S5-V100	STANDARD IEC	NONE	NONE	1045 HOT ROLLED (C-204)	CAST IRON
BALL	BALL						
6314	6314						

THERMOSTATS	PROTECTORS	WDG RTD's	BRG RTD's	THERMISTORS	CONTROL	SPACE HEATERS
NONE	NOT	NONE	NONE	NONE	FALSE	NA

R1 (ohms/ph)	R2 (ohms/ph)	X1 (ohms/ph)	X2 (ohms/ph)	Xm (ohms/ph)	VIBRATION (in/sec)	FLOAT
0.052	0.033	0.336	0.449	8.891	0.150	ODE

* N O T E S *	INVERTER TORQUE: CONSTANT 2:1/VARIABLE 10:1 INV. HP SPEED RANGE: NONE					
	ENCODER: NONE					
	NONE					
	NONE PPR					
	BRAKE: NONE					

PREPARED BY: _____	BRAKE: NONE
DATE: 11/16/2020	NONE NONE
	FT-LB: NA
	VOLTAGE: NONE
	HZ: _____
FORM: 3531 REV_4 2/27/06	UL: V - LI,ME-INS,CONST UL REC



Data Sheet

TCA0453AE211GAA009

Date: 5/29/2019
Customer:
Attention:

Submittal

Submitted by: Fareeda Dudekula

Data @ 460 V

Motor Load Data

Load	0%	25%	50%	75%	100%	115%	125%	LR
Current (Amps)	29.5	35.9	44.9	58.3	73.0	82.6	89.3	483
Torque (ft-lb)	0.00	65.8	132	198	265	305	332	494
RPM	1200	1197	1195	1192	1190	1,188	1187	0
Efficiency (%)		87.6	92.4	94.5	94.5	93.9	93.8	
P.F. (%)	6.0	45.0	68.0	77.0	82.0	83.0	84.0	63.4

Motor Speed Data

	LR	Pull-Up	BD	Rated	Idle
Speed (RPM)	0	400	1136	1190	1200
Current (Amps)	483	459	263	73.0	29.5
Torque (ft-lb)	494	469	702	265	0.00

Information Block				
HP	60.0			
Sync. RPM	1200			
Frame	280			
Enclosure	TEFC			
Construction	TCA 280S06			
Voltage	230/460#200/400 V			
Frequency	60 Hz			
Design	N			
LR Code letter	H			
Service Factor	1.15			
Temp Rise @ FL	80 °C			
Duty	CONT			
Ambient	40 °C			
Elevation	3,300 feet			
Rotor/Shaft wk ²	53.2 Lb-Ft ²			
Ref Wdg	IE3L2806201 NONE			
Sound Pressure @ 1M	70 dBA			
VFD Rating	CONSTANT 2:1/VARIABLE 10:1			
Outline Dwg	SS557726			
Conn. Diag	8442000677			
Additional Specifications:				
0				
0				
EQUIV CKT (OHMS / PHASE)				
R1	R2	X1	X2	Xm
0.0520	0.0330	0.3360	0.4490	8.8910

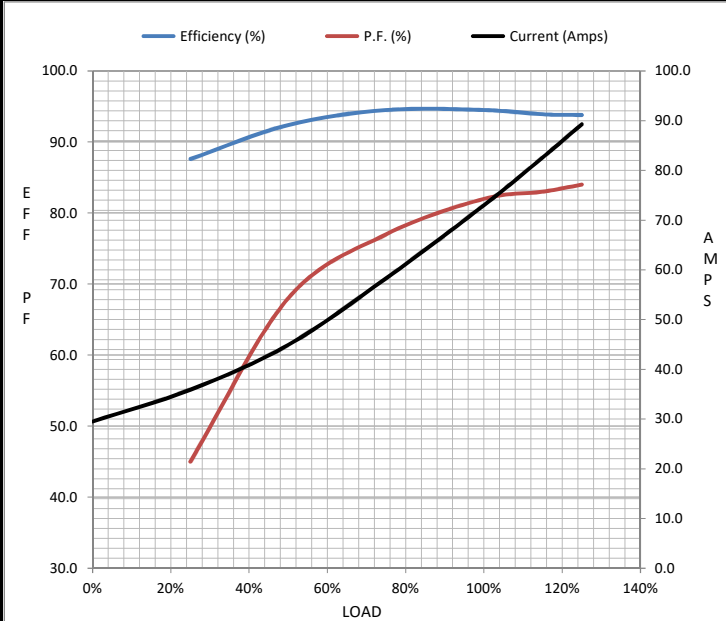

Speed -Torque Curve

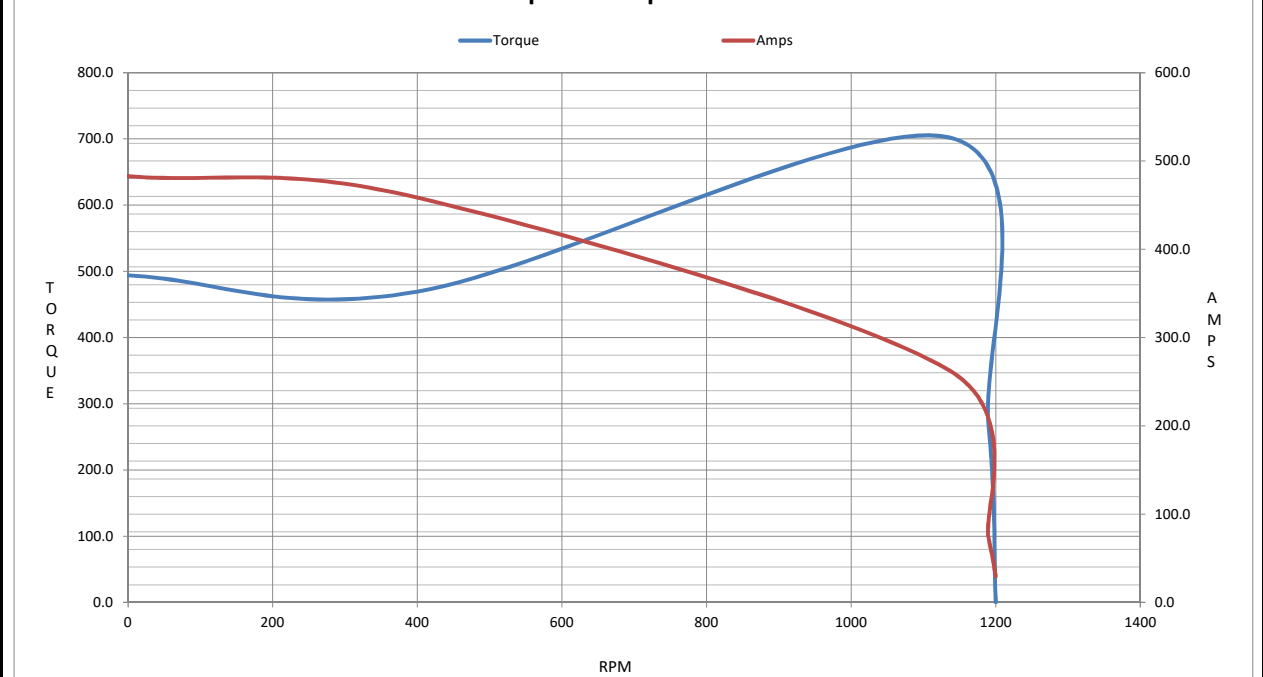

EC Declaration of Conformity

The undersigned representing
the manufacturer:

Regal Beloit America
100 East Randolph St.
Wausau, WI 54401

and the authorized representative
established within the Community:

Marathon Electric UK
6F Thistleton Road Ind. Estate
Market Overton
Oakham, Rutland LE15 7PP UK

are committed to providing customers with products that comply with applicable regulations and international protocols to which they are subject, including the requirements of the European Parliament Directive on the Harmonization of the laws relating to electrical equipment designed for use within certain voltage limits (2014/35/EU).

Regal Beloit America declares that the following product(s), to which this declaration relates, are in conformity with the relevant sections of the EC standards listed below.

This statement supersedes any statements previously issued pertaining to the product(s) listed below and is subject to change without notice.

Model No : TCA0453AE211GAA009

(Model No. may contain prefix and/or suffix characters)

Catalog No : R502A

Rework No : N/A

Directives :

Low Voltage Directive 2014/35/EU

Harmonized Standards Used :

EN 60034-1: 2010 (IEC 60034-1: 2010)

EN 60034-5: 2001/A1:2007 (IEC 60034-5: 2000/A1:2006)

Authorized Representative:



Michael A. Logsdon
Vice President, Technology

Authorized Representative in the Community:



Julian Clark
Marketing Engineer

Created on 09/01/2022

CE 22