

PRODUCT INFORMATION PACKET

Model No: TCA0112A3131GACD01

Catalog No: TCA0112A3131GACD01

Cast Iron Motor, 15 HP, 3 Ph, 50 Hz, 415 V, 1500 RPM, 160M Frame, TEFC



Regal and Marathon are trademarks of Regal Rexnord Corporation or one of its affiliated companies.
©2022 Regal Rexnord Corporation, All Rights Reserved. MC017097E

Nameplate Specifications

Output HP	15 Hp	Output KW	11.0 kW
Frequency	50 Hz	Voltage	415 V
Current	19.7 A	Speed	1474 rpm
Service Factor	1	Phase	3
Efficiency	91.4 %	Power Factor	0.85
Duty	S1	Insulation Class	F
Frame	160M	Enclosure	Totally Enclosed Fan Cooled
Thermal Protection	No Protection	Ambient Temperature	50 °C
Drive End Bearing Size	6309	Opp Drive End Bearing Size	6209
UL	No	CSA	No
CE	Yes	IP Code	55
Number of Speeds	1	Efficiency Class	IE3



Technical Specifications

Electrical Type	Squirrel Cage	Starting Method	Direct On Line
Poles	4	Rotation	Bi-Directional
Mounting	B35	Motor Orientation	Horizontal
Drive End Bearing	2z-C3	Opp Drive End Bearing	2z-C3
Frame Material	Cast Iron	Shaft Type	Keyed
Overall Length	622 mm	Frame Length	254 mm
Shaft Diameter	42 mm	Shaft Extension	110 mm
Assembly/Box Mounting	Top		
Outline Drawing	0216000480	Connection Drawing	8442000085

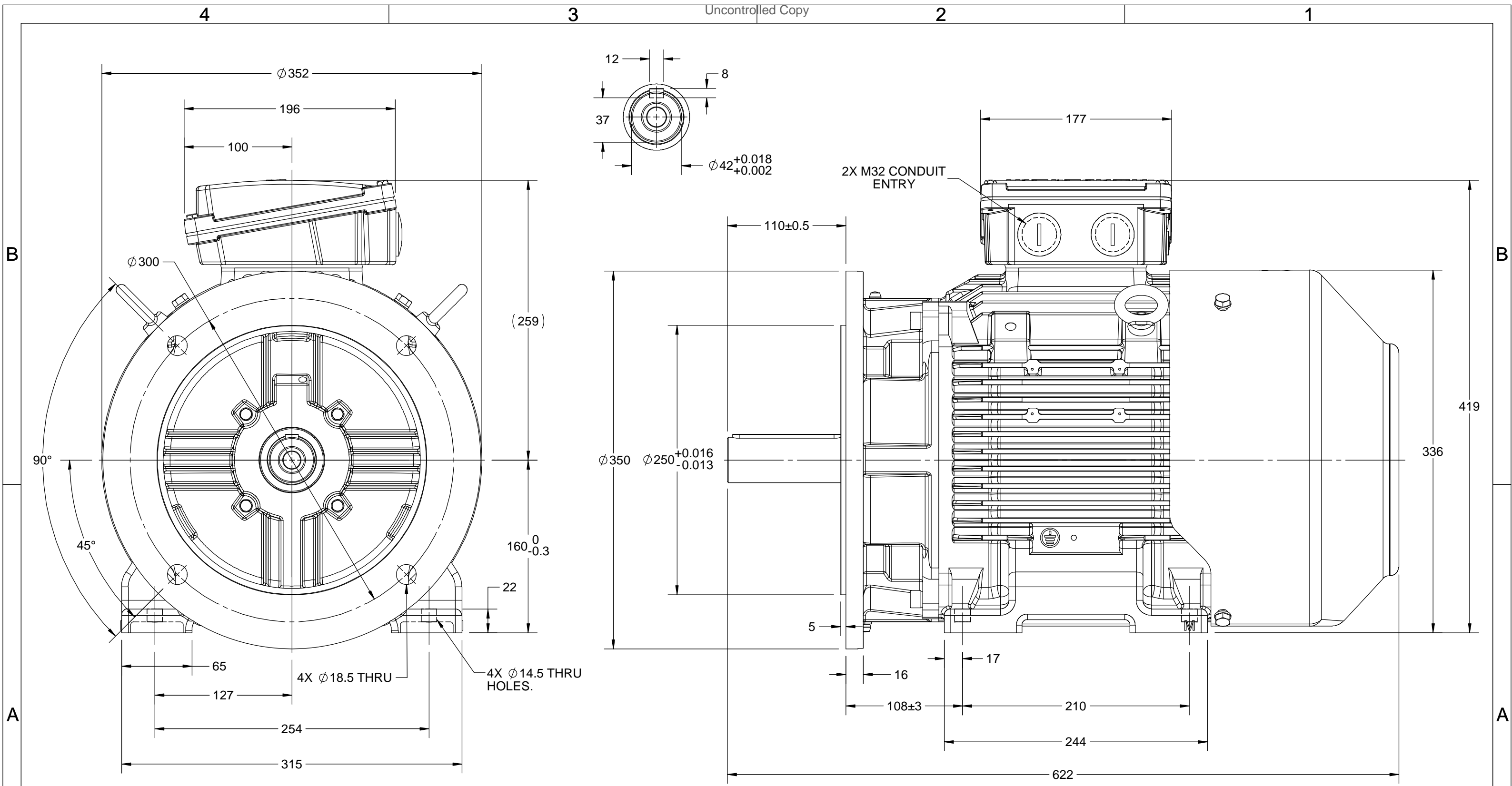
This is an uncontrolled document once printed or downloaded and is subject to change without notice. Date Created:12/01/2022



DRAWING REVISION B	REVISION BY I. RAMDAS	DATE 06/07/2018
ECO ECO-0147359	APPROVED BY JAY	DATE 06/07/2018
ECO DESCRIPTION OUTLINE UPDATED AS PER NEW 3D STRUCTURING		
<small>COPYRIGHT REGAL BELOIT AMERICA, INC. ALL RIGHTS RESERVED. PROPRIETARY AND CONFIDENTIAL INFORMATION - THIS DOCUMENT IS THE PROPERTY OF REGAL BELOIT AMERICA, INC. ("OWNER") AND CONTAINS OWNER'S PROPRIETARY INFORMATION. ANY PERSON, CORPORATION OR OTHER FIRM RECEIVING IT IS DEEMED, BY RECEIVING IT, TO AGREE THAT IT, AND/OR ANY PART OF IT, SHALL NOT BE DISCLOSED TO ANY PERSON, CORPORATION OR OTHER ENTITY, DUPLICATED, AND/OR USED, EXCEPT AS EXPRESSLY APPROVED IN WRITING IN ADVANCE BY OWNER. THIS DOCUMENT SHALL BE RETURNED TO OWNER UPON REQUEST. IT MAY BE SUBJECT TO CERTAIN RESTRICTIONS UNDER APPLICABLE EXPORT CONTROL LAWS AND REGULATIONS.</small>		

DRAWN BY KCS	 Regal Beloit America, Inc.
DATE 10/11/2014	
APPROVED BY SBD	DESCRIPTION OUTLINE 160M FR B35 MTG. MOTOR TYPE TCA
DATE 10/11/2014	MATERIAL
REFERENCE	PROCESS/FINISH
THIRD ANGLE PROJECTION 	SIZE B
	DRAWING NUMBER 0216000480
	SHEET 1 OF 1

COPYRIGHT REGAL BELOIT AMERICA, INC. ALL RIGHTS RESERVED. PROPRIETARY AND CONFIDENTIAL INFORMATION - THIS DOCUMENT IS THE PROPERTY OF REGAL BELOIT AMERICA, INC. ("OWNER") AND CONTAINS OWNER'S PROPRIETARY INFORMATION. ANY PERSON, CORPORATION OR OTHER FIRM RECEIVING IT IS DEEMED, BY RECEIVING IT, TO AGREE THAT IT, AND/OR ANY PART OF IT, SHALL NOT BE DISCLOSED TO ANY PERSON, CORPORATION OR OTHER ENTITY, DUPLICATED, AND/OR USED, EXCEPT AS EXPRESSLY APPROVED IN WRITING IN ADVANCE BY OWNER. THIS DOCUMENT SHALL BE RETURNED TO OWNER UPON REQUEST. IT MAY BE SUBJECT TO CERTAIN RESTRICTIONS UNDER APPLICABLE EXPORT CONTROL LAWS AND REGULATIONS.

DRAWING REVISION A	REVISION BY SN	DATE 13/01/2017
ECO ECO-0116390	APPROVED BY SBD	DATE 13/01/2017
ECO DESCRIPTION NEW DRAWING RELEASE		

GEOMETRIC TOLERANCE		
LINEAR DIM	>0~6	±0.1
	>6~30	±0.2
	>30~120	±0.3



NOTES:

1. PRESSURE-SENSITIVE ADHESIVE COATED PAPER ON THE BACK OF SELF-ADHESIVE.
2. AT THE END OF YELLOW, WORDS, SYMBOLS, LETTERS ARE BLACK, BORDER IS BLACK.
3. THE TOLERANCE OF THE LINEAR SIZE OF THE TOLERANCE WITHOUT THE TOLERANCE BY THE TABLE.

8WD.442.2017



DRAWN BY SN	DATE 16/12/2016		Regal Beloit America, Inc.	
	APPROVED BY SBD	DESCRIPTION CONN DIAGRAM-NAMEPLATE		
	DATE 16/12/2016	MATERIAL	PROCESS/FINISH	
	REFERENCE	SIZE A	DRAWING NUMBER 8442000085	SHEET 1 OF 1
	THIRD ANGLE PROJECTION			

Model No. TCA0112A3131GACD01

U (V)	Δ / Y Conn	f (Hz)	P		I [A]	n [RPM]	T [Nm]	IE Class	% EFF at __ load				PF at __ load			I _A /I _N [pu]	T _A /T _N [pu]	T _R /T _N [pu]
			[kW]	[hp]					5/4FL	FL	3/4FL	1/2FL	FL	3/4FL	1/2FL			
415	Δ	50	11	15	19.7	1474	72.48	IE3	-	91.4	91.4	90.9	0.85	0.8	0.68	6.9	2.4	3.1

Motor type	TCA
Enclosure	TEFC
Frame Material	Cast Iron
Frame size	160M
Duty	S1
Voltage variation *	± 10%
Frequency variation *	± 5%
Combined variation *	10%
Design	N
Service factor	1.0
Insulation class	F
Ambient temperature	-20 to +50 °C
Temperature rise (by resistance)	70 [Class B] K
Altitude above sea level	1000 meter
Hazardous area classification	NA
Zone classification	NA
Gas group	NA
Temperature class	NA
Rotor type	Aluminum Die cast
Bearing type	Anti-friction ball bearing
DE / NDE bearing	6309-2Z / 6209-2Z
Lubrication method	Greased for life
Type of grease	NA

Degree of protection	IP 55
Mounting type	IM B35
Cooling method	IC 411
Motor weight - approx.	153 kg
Gross weight - approx.	173 kg
Motor inertia	0.1200 kgm ²
Load inertia	Customer to Provide
Vibration level	2.2 mm/s
Noise level (1meter distance from motor)	64 dB(A)
No. of starts hot/cold/Equally spread	2/3/4
Starting method	DOL
Type of coupling	Direct
LR withstand time (hot/cold)	12/25 s
Direction of rotation	Bi-directional
Standard rotation	Clockwise form DE
Paint shade	RAL 5014
Accessories	
Accessory - 1	-
Accessory - 2	-
Accessory - 3	-
Terminal box position	TOP
Maximum cable size/conduit size	1R x 3C x 35mm ² /2 X M32 x 1.5
Auxiliary terminal box	NA

I_A/I_N - Locked Rotor Current / Rated Current

T_R/T_N - Breakdown Torque / Rated Torque

T_A/T_N - Locked Rotor Torque / Rated Torque

NOTE

All performance values at rated voltage and frequency.

All performance parameters are subjected to standard tolerance as per IEC 60034-1

* Voltage, Frequency and combine variation are as per IEC60034-1

Technical data are subject to change. There may be discrepancies between calculated and name plate values.

Efficiency Standards	Europe	China	India	Aus/Nz	Brazil	Global IEC
	-	-	IS 12615 : 2018	-	-	-



Model No. TCA0112A3131GACD01

Enclosure	U (V)	Δ / Y Conn	f (Hz)	P [kW]	P [hp]	I [A]	n [RPM]	T [kgm]	T [Nm]	IE Class	Amb [°C]	Duty	Elevation [m]	Inertia [kg-m ²]	Weight [kg]
TEFC	415	Δ	50	11	15.0	19.7	1474	7.39	72.48	IE3	50	S1	1000	0.12	153

Motor Load Data

Load Point		NL	1/4FL	1/2FL	3/4FL	FL	5/4FL
Current	A	8.2	9.3	12.0	15.6	19.7	
Torque	Nm	0.0	17.9	35.9	54.1	72.5	
Speed	r/min	1500	1494	1487	1481	1474	
Efficiency	%	0.0	86.5	90.9	91.4	91.4	
Power Factor	%	6.7	48.4	68.0	80.0	85.0	

Performance vs Load Chart

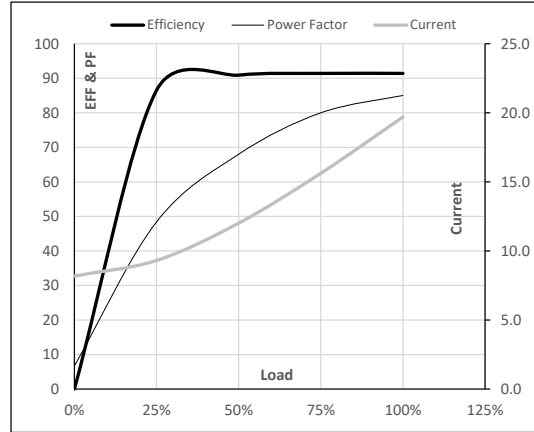

Motor Speed Torque Data

Load Point		LR	P-Up	BD	Rated	NL
Speed	r/min	0	214	1316	1474	1500
Current	A	135.9	122.3	81.0	19.7	8.2
Torque	pu	2.4	2.0	3.1	1	0

Starting Characteristics Chart

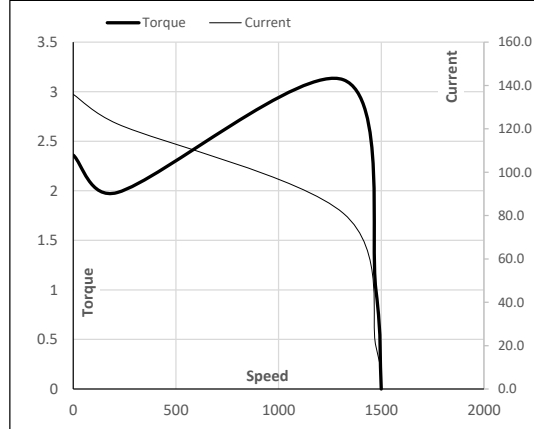

NOTE Refer data sheet for applicable standard and tolerances on performance parameters

Issued By
Issued Date





Model No. TCA0112A3131GACD01

Enclosure	U (V)	Δ / Y Conn	f [Hz]	P [kW]	P [hp]	I [A]	n [rpm]	T [kgm]	T [Nm]	IE Class	Amb [°C]	Duty	Elevation [m]	Inertia [kg·m ²]	Weight [kg]
TEFC	415	Δ	50	11	15	19.7	1474	7.39	72.48	IE3	50	S1	1000	0.1200	153

Motor Speed Torque Data

Load	FL	I ₁	I ₂	I ₃	I ₄	I ₅	LR	
TWT Hot	s 10000	41	28	25	16	15	12	
TWT Cold	s 10000	90	58	50	33	31	25	
Current	pu	1	2	3	4	5	5.5	6.9

Thermal Characteristics Chart

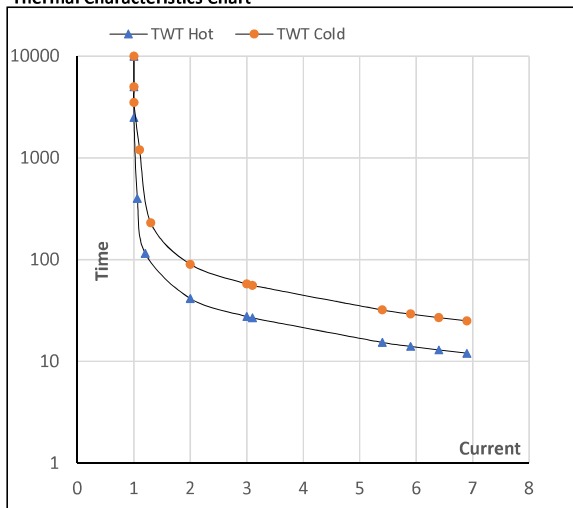

NOTE Refer data sheet for applicable standard and tolerances on performance parameters

Issued By
Issued Date



EC Declaration of Conformity

The undersigned representing
the manufacturer:

Regal Beloit America
100 East Randolph St.
Wausau, WI 54401

and the authorized representative
established within the Community:

Marathon Electric UK
6F Thistleton Road Ind. Estate
Market Overton
Oakham, Rutland LE15 7PP UK

are committed to providing customers with products that comply with applicable regulations and international protocols to which they are subject, including the requirements of the European Parliament Directive on the Harmonization of the laws relating to electrical equipment designed for use within certain voltage limits (2014/35/EU).

Regal Beloit America declares that the following product(s), to which this declaration relates, are in conformity with the relevant sections of the EC standards listed below.

This statement supersedes any statements previously issued pertaining to the product(s) listed below and is subject to change without notice.

Model No : TCA0112A3131GACD01

(Model No. may contain prefix and/or suffix characters)

Catalog No : TCA0112A3131GACD01

Rework No : N/A

Directives :

Low Voltage Directive 2014/35/EU

Harmonized Standards Used :

EN 60034-1: 2010 (IEC 60034-1: 2010)

EN 60034-5: 2001/A1:2007 (IEC 60034-5: 2000/A1:2006)

Authorized Representative:

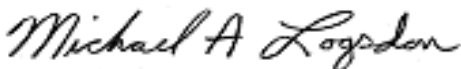

Michael A. Logsdon
Vice President, Technology

Authorized Representative in the Community:



Julian Clark
Marketing Engineer

Created on 09/01/2022

CE 22