

PRODUCT INFORMATION PACKET

Model No: TCA0111AE231GAA009

Catalog No: R833

TerraMAX® Cast Iron Motor, 15 & 10 HP, 3 Ph, 60 & 50 Hz, 230/460 & 200/400 V, 3600 & 3000 RPM,
160M Frame, TEFC



Regal and Marathon are trademarks of Regal Rexnord Corporation or one of its affiliated companies.

©2023 Regal Rexnord Corporation, All Rights Reserved. MC017097E

Nameplate Specifications

Phase	3	Output HP	15 & 10 Hp
Output KW	11.0 & 7.5 kW	Voltage	230/460 & 200/400 V
Speed	3550 & 2965 rpm	Service Factor	1.15 & 1.15
Frame	160M	Enclosure	Totally Enclosed Fan Cooled
Thermal Protection	No Protection	Efficiency	91 & 90.1 %
Ambient Temperature	40 °C	Frequency	60 & 50 Hz
Current	34/16.9 & 27.8/13.9 A	Power Factor	90
Duty	Continuous	Insulation Class	F
Design Code	N (IEC)	KVA Code	G
Drive End Bearing Size	6309	Opp Drive End Bearing Size	6209
UL	Recognized	CSA	N
CE	Y	IP Code	55
Number of Speeds	1	Efficiency Class	IE3

Technical Specifications

Electrical Type	Squirrel Cage Inverter Rated	Starting Method	Line Or Inverter
Poles	2	Rotation	Reversible
Resistance Main	.93 Ohms	Mounting	B3
Motor Orientation	Horizontal	Drive End Bearing	Ball
Opp Drive End Bearing	Ball	Frame Material	Cast Iron
Shaft Type	IEC	Shaft Diameter	42.000 in
Assembly/Box Mounting	F3	Inverter Load	CONSTANT 2:1/VARIABLE 10:1
Connection Drawing	8442000715	Outline Drawing	SS620876

This is an uncontrolled document once printed or downloaded and is subject to change without notice. Date Created:06/22/2023

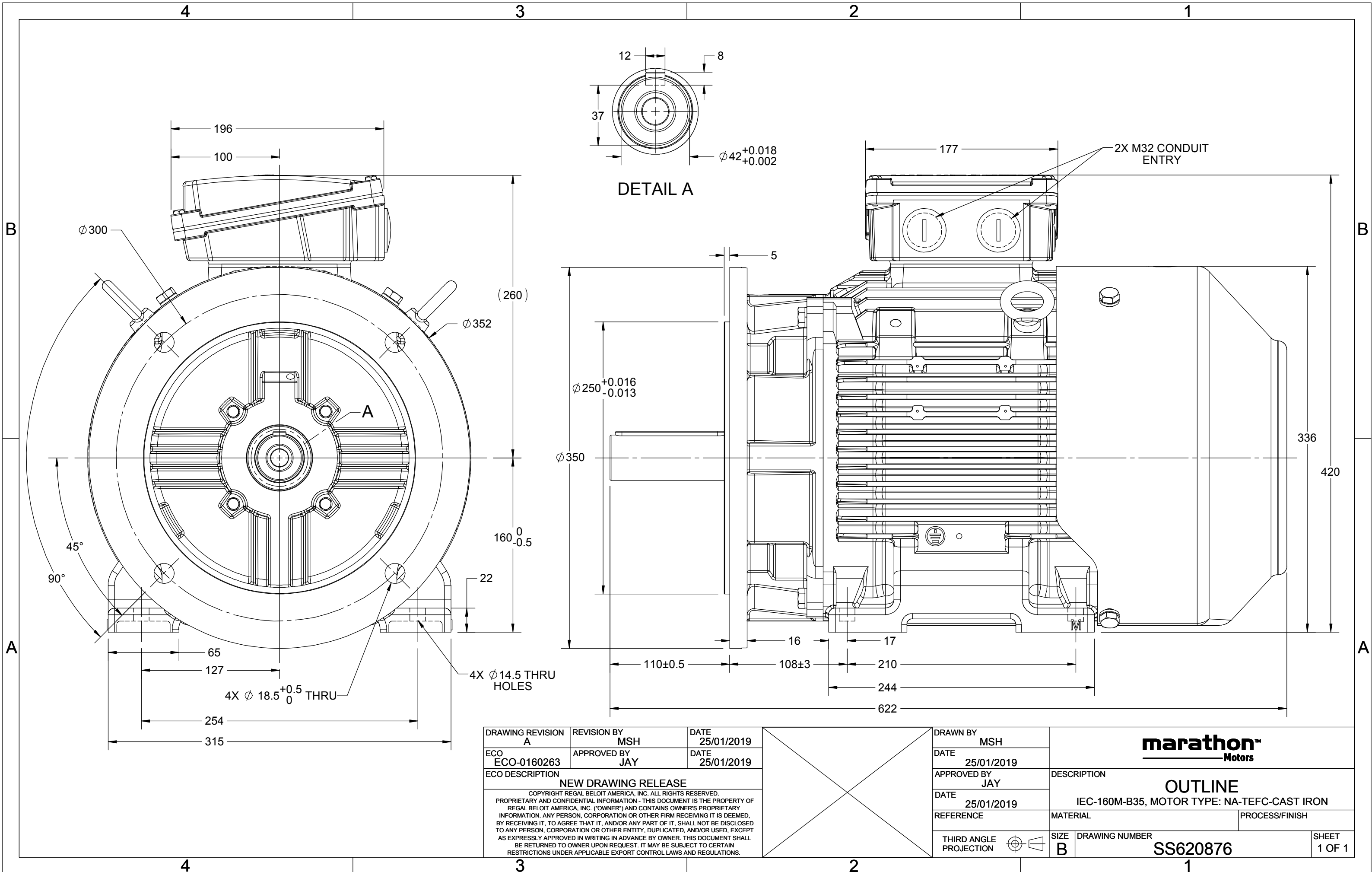

DRAWING REVISION A	REVISION BY MSH	DATE 25/01/2019
ECO ECO-0160263	APPROVED BY JAY	DATE 25/01/2019
ECO DESCRIPTION NEW DRAWING RELEASE COPYRIGHT REGAL BELOIT AMERICA, INC. ALL RIGHTS RESERVED. PROPRIETARY AND CONFIDENTIAL INFORMATION - THIS DOCUMENT IS THE PROPERTY OF REGAL BELOIT AMERICA, INC. ("OWNER") AND CONTAINS OWNER'S PROPRIETARY INFORMATION. ANY PERSON, CORPORATION OR OTHER FIRM RECEIVING IT IS DEEMED, BY RECEIVING IT, TO AGREE THAT IT, AND/OR ANY PART OF IT, SHALL NOT BE DISCLOSED TO ANY PERSON, CORPORATION OR OTHER ENTITY, DUPLICATED, AND/OR USED, EXCEPT AS EXPRESSLY APPROVED IN WRITING IN ADVANCE BY OWNER. THIS DOCUMENT SHALL BE RETURNED TO OWNER UPON REQUEST. IT MAY BE SUBJECT TO CERTAIN RESTRICTIONS UNDER APPLICABLE EXPORT CONTROL LAWS AND REGULATIONS.		

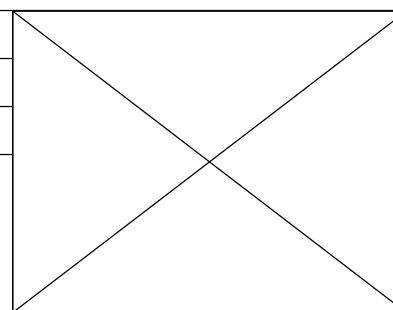

DRAWN BY MSH
DATE 25/01/2019
APPROVED BY JAY
DATE 25/01/2019
REFERENCE
THIRD ANGLE PROJECTION

marathon™ Motors	
OUTLINE	
IEC-160M-B35, MOTOR TYPE: NA-TEFC-CAST IRON	
MATERIAL	PROCESS/FINISH
SIZE B	DRAWING NUMBER SS620876
SHEET 1 OF 1	

COPYRIGHT REGAL BELOIT AMERICA, INC. ALL RIGHTS RESERVED.
 PROPRIETARY AND CONFIDENTIAL INFORMATION - THIS DOCUMENT IS THE PROPERTY OF
 REGAL BELOIT AMERICA, INC. ("OWNER") AND CONTAINS OWNER'S PROPRIETARY
 INFORMATION. ANY PERSON, CORPORATION OR OTHER FIRM RECEIVING IT IS DEEMED,
 BY RECEIVING IT, TO AGREE THAT IT, AND/OR ANY PART OF IT, SHALL NOT BE DISCLOSED
 TO ANY PERSON, CORPORATION OR OTHER ENTITY, DUPLICATED, AND/OR USED, EXCEPT
 AS EXPRESSLY APPROVED IN WRITING IN ADVANCE BY OWNER. THIS DOCUMENT SHALL
 BE RETURNED TO OWNER UPON REQUEST. IT MAY BE SUBJECT TO CERTAIN
 RESTRICTIONS UNDER APPLICABLE EXPORT CONTROL LAWS AND REGULATIONS.

DRAWING REVISION A	REVISION BY S.MUDDA	DATE 16/11/2020
ECO ECO-0194685	APPROVED BY SUMANTA	DATE 16/11/2020
ECO DESCRIPTION NEW DRAWING		

GEOMETRIC TOLERANCE		
LINEAR DIM	>0~6	±0.1
	>6~30	±0.2
	>30~120	±0.3

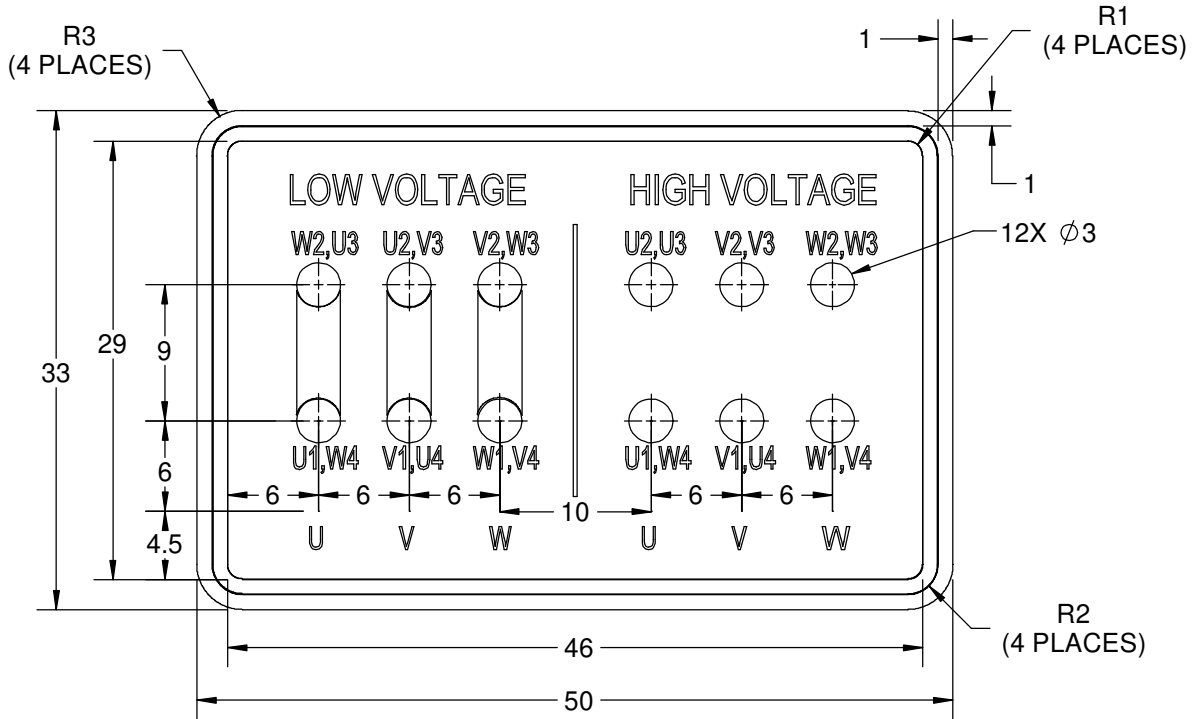



NOTES:

1. PRESSURE-SENSITIVE ADHESIVE COATED PAPER ON THE BACK OF SELF-ADHESIVE.
2. AT THE END OF YELLOW, WORDS, SYMBOLS, LETTERS ARE BLACK, BORDER IS BLACK.
3. THE TOLERANCE OF THE LINEAR SIZE OF THE TOLERANCE WITHOUT THE TOLERANCE BY THE TABLE.
4. LEAD TERMINAL MARKINGS FONT SIZE : T1-T12 & U1-U4,V1-V4& W1-W4 OF ARIAL WITH 3mm SIZE
5. OTHER LETTER FONT SIZE SHOULD BE 3.5mm.

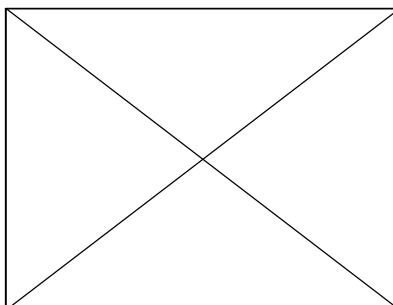
8WD.442.2017



DRAWN BY S.MUDDA	DATE 16/11/2020	 Regal Beloit America, Inc.		
	APPROVED BY SUMANTA		DESCRIPTION CONN DIAGRAM-NAMEPLATE	
	DATE 16/11/2020	MATERIAL	PROCESS/FINISH	
	REFERENCE	SIZE A	DRAWING NUMBER 8442000715	SHEET 1 OF 1
	THIRD ANGLE PROJECTION 			



P.O. BOX 8003
WAUSAU, WI 54401-8003
PH. 715-675-3311

DATA VOLTS: 460

CERTIFICATION DATA SHEET

CUSTOMER: _____
ORDER #: _____
CONN. DIAGRAM: 8442000677
OUTLINE: SS620876
WINDING: IE3L1602201 NONE 1
SPEED: _____

CUSTOMER P.O. #: _____
REFERENCE MODEL #: TCA0111AE231GAA009
CAT #: R833
CUSTOMER PART #: _____
MOUNTING: F3

TYPICAL MOTOR PERFORMANCE DATA

HP	KW	SYNC RPM	FL RPM	FRAME	ENCLOSURE	TYPE	KVA CODE	DESIGN
15	11.00	3600	3550	160M	TEFC	TCA 160MB02	G	B

PH	HZ	VOLTS	AMPS	START TYPE	DUTY	INSL	S.F.	AMB (° C)	ELEV.(Ft.)
3	60/50	230/460#200/400	34/16.9&27.8/13.9	LINE OR INVERTER	CONT	F	1.15	40	3300

F.L. EFF	91.0	3/4 LD EFF	91.0	1/2 LD EFF	90.3	GTD EFF	ELECT. TYPE
F.L. PF	90.0	3/4 LD PF	86.0	1/2 LD PF	79.0	89.7	SQ CAGE INV RATED

F.L. TORQUE	LR AMPS @ 460 V	L.R. TORQUE	B.D. TORQUE	F.L. RISE (° C)
22.2 LB-FT	118	37.6 LB-FT 169%	64.0 LB-FT 288%	80

SOUND PRESSURE @ 3 FT.	SOUND POWER	ROTOR WK ²	MAX. LOAD WK ²	SAFE STALL TIME	STARTS/HOUR	APROX. MOTOR WGT
75 dBA	84 dBA	1.49 LB-FT ²	1.49 LB-FT ²	10 SEC.	2	148 KG.

***** SUPPLEMENTAL INFORMATION *****

DE BRACKET TYPE	ODE BRACKET TYPE	MOUNT TYPE	MOTOR ORIENTATION	SEVERE DUTY	HAZARDOUS LOCATION	DRIP COVER	SCREENS	PAINT
FF-FLANGE-300	STANDARD	B3	HORIZONTAL	NO	NONE	NO	NONE	BLUE (ENAMEL)

BEARINGS		GREASE	SHAFT TYPE	SPECIAL DE	SPECIAL ODE	SHAFT MATERIAL	FRAME MATERIAL
DE BALL	ODE BALL	POLYREX EM	STANDARD IEC	NONE	NONE	1045 HOT ROLLED (C-204)	CAST IRON
6309	6209						

THERMOSTATS	PROTECTORS	WDG RTD's	BRG RTD's	THERMISTORS	CONTROL	SPACE HEATERS
NONE	NOT	NONE	NONE	NONE	FALSE	NA

R1 (ohms/ph)	R2 (ohms/ph)	X1 (ohms/ph)	X2 (ohms/ph)	Xm (ohms/ph)	VIBRATION (in/sec)	FLOAT
0.567	0.227	1.229	1.097	47.994	0.150	ODE

* N O T E S *	INVERTER TORQUE: CONSTANT 2:1/VARIABLE 10:1 INV. HP SPEED RANGE: NONE					
	ENCODER: NONE					
	NONE					
	NONE PPR					
	BRAKE: NONE					

PREPARED BY: _____	BRAKE: NONE
DATE: 11/27/2020	NONE NONE
	FT-LB: NA
	VOLTAGE: NONE
	HZ: _____
	UL: V - LI,ME-INS,CONST UL REC

FORM: 3531 REV_4 2/27/06





Data Sheet

Date: 4/9/2020 TCA0111AE231GAA009

Customer: _____

Attention: _____ **Submittal**

Submitted by: _____ Data @ 460 V

Motor Load Data									
Load	0%	25%	50%	75%	100%	115%	125%	LR	
Current (Amps)	5.4	7.1	9.8	13.4	16.9	19.7	21.4	118	
Torque (ft-lb)	0.00	5.5	11.0	16.6	22.2	25.6	27.9	37.6	
RPM	3600	3588	3576	3563	3550	3541	3535	0	
Efficiency (%)		85.4	90.3	91.0	91.0	90.4	90.0		
P.F. (%)	10.0	58.0	79.0	86.0	90.0	91.0	91.0	63.4	

Motor Speed Data						Information Block	
	LR	Pull-Up	BD	Rated	Idle		
Speed (RPM)	0	1200	3259	3550	3600	HP	15.0
Current (Amps)	118	112	71.8	16.9	5.4	Sync. RPM	3600
Torque (ft-lb)	37.6	35.7	64.0	22.2	0.00	Frame	160
						Enclosure	TEFC
						Construction	TCA 160MB02
						Voltage	230/460#200/400 V
						Frequency	60 Hz
						Design	N
						LR Code letter	G
						Service Factor	1.15
						Temp Rise @ FL	80 °C
						Duty	CONT
						Ambient	40 °C
						Elevation	3,300 feet
						Rotor/Shaft wk ²	1.49 Lb-Ft ²
						Ref Wdg	IE3L1602201 NONE
						Sound Pressure @ 1M	75 dBA
						VFD Rating	CONSTANT 2:1/VARIABLE 10:1
						Outline Dwg	SS620876
						Conn. Diag	8442000677
Additional Specifications:							
0							
0							
EQUIV CKT (OHMS / PHASE)							
	R1	R2	X1	X2	Xm		
	0.5670	0.2270	1.2290	1.0970	47.9940		

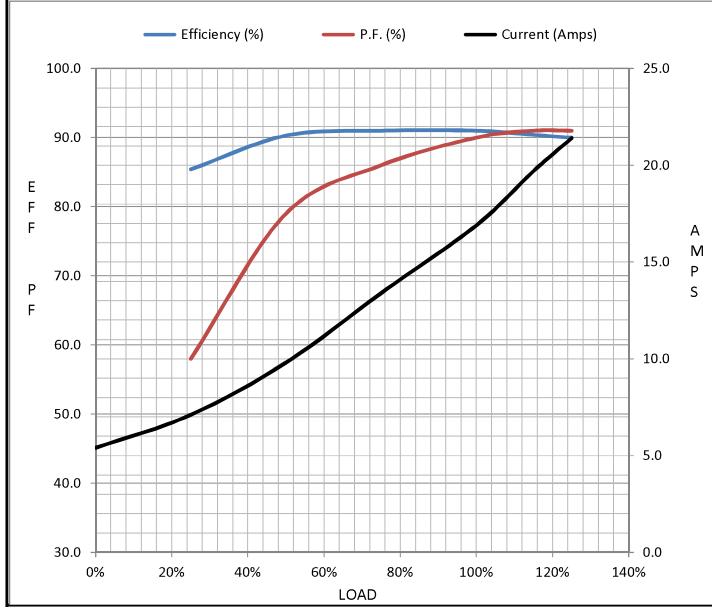

HP	15.0				
Sync. RPM	3600				
Frame	160				
Enclosure	TEFC				
Construction	TCA 160MB02				
Voltage	230/460#200/400 V				
Frequency	60 Hz				
Design	N				
LR Code letter	G				
Service Factor	1.15				
Temp Rise @ FL	80 °C				
Duty	CONT				
Ambient	40 °C				
Elevation	3,300 feet				
Rotor/Shaft wk ²	1.49 Lb-Ft ²				
Ref Wdg	IE3L1602201 NONE				
Sound Pressure @ 1M	75 dBA				
VFD Rating	CONSTANT 2:1/VARIABLE 10:1				
Outline Dwg	SS620876				
Conn. Diag	8442000677				
Additional Specifications:					
0					
0					
EQUIV CKT (OHMS / PHASE)					
	R1	R2	X1	X2	Xm
	0.5670	0.2270	1.2290	1.0970	47.9940

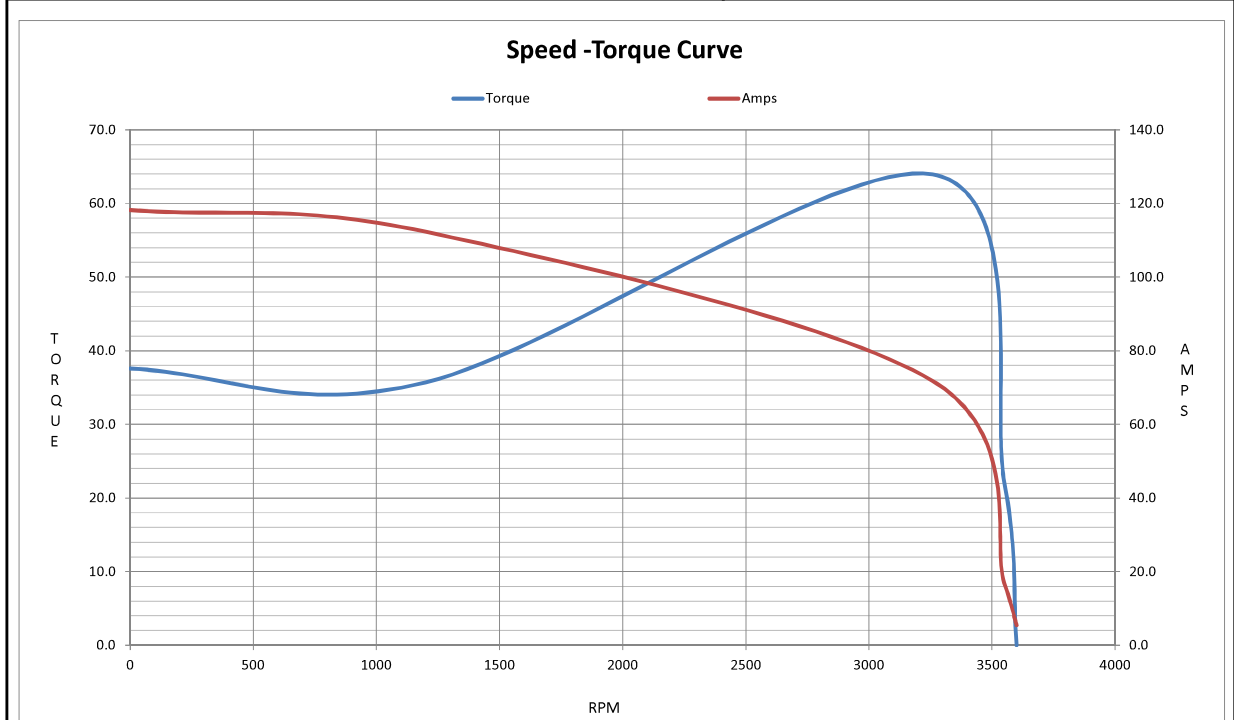

EC Declaration of Conformity

The undersigned representing
the manufacturer:

Regal Beloit America
100 East Randolph St.
Wausau, WI 54401

and the authorized representative
established within the Community:

Marathon Electric UK
6F Thistleton Road Ind. Estate
Market Overton
Oakham, Rutland LE15 7PP UK

are committed to providing customers with products that comply with applicable regulations and international protocols to which they are subject, including the requirements of the European Parliament Directive on the Harmonization of the laws relating to electrical equipment designed for use within certain voltage limits (2014/35/EU).

Regal Beloit America declares that the following product(s), to which this declaration relates, are in conformity with the relevant sections of the EC standards listed below.

This statement supersedes any statements previously issued pertaining to the product(s) listed below and is subject to change without notice.

Model No : TCA0111AE231GAA009

(Model No. may contain prefix and/or suffix characters)

Catalog No : R833

Rework No : N/A

Directives :

Low Voltage Directive 2014/35/EU

Harmonized Standards Used :

EN 60034-1: 2010 (IEC 60034-1: 2010)

EN 60034-5: 2001/A1:2007 (IEC 60034-5: 2000/A1:2006)

Authorized Representative:



Michael A. Logsdon
Vice President, Technology

Authorized Representative in the Community:



Julian Clark
Marketing Engineer

Created on 09/01/2022

CE 22