

PRODUCT INFORMATION PACKET

Model No: SCA7P51A4121GAA001

Catalog No: SCA7P51A4121GAA001

TerraMAX® Cast Iron Motor, 10 HP, 3 Ph, 50 Hz, 380/660 V, 3000 RPM, 132S Frame, TEFC



Regal and Marathon are trademarks of Regal Rexnord Corporation or one of its affiliated companies.

©2022 Regal Rexnord Corporation, All Rights Reserved. MC017097E



Nameplate Specifications

Output HP	10 Hp	Output KW	7.5 kW
Frequency	50 Hz	Voltage	380/660 V
Current	13.8 A	Speed	2906 rpm
Service Factor	1	Phase	3
Efficiency	88.1 %	Power Factor	0.94
Duty	S1	Insulation Class	F
Frame	132S	Enclosure	Totally Enclosed Fan Cooled
Thermal Protection	No Protection	Ambient Temperature	40 °C
Drive End Bearing Size	6308	Opp Drive End Bearing Size	6208
UL	No	CSA	No
CE	Yes	IP Code	55
Number of Speeds	1	Efficiency Class	IE2

Technical Specifications

Electrical Type	Squirrel Cage	Starting Method	Direct On Line
Poles	2	Rotation	Bi-Directional
Mounting	B5	Motor Orientation	Horizontal
Drive End Bearing	2z-C3	Opp Drive End Bearing	2z-C3
Frame Material	Cast Iron	Shaft Type	Keyed
Overall Length	465 mm	Frame Length	202 mm
Shaft Diameter	38 mm	Shaft Extension	80 mm
Assembly/Box Mounting	Top		
Outline Drawing	0213201091	Connection Drawing	8442000085

This is an uncontrolled document once printed or downloaded and is subject to change without notice. Date Created:12/01/2022

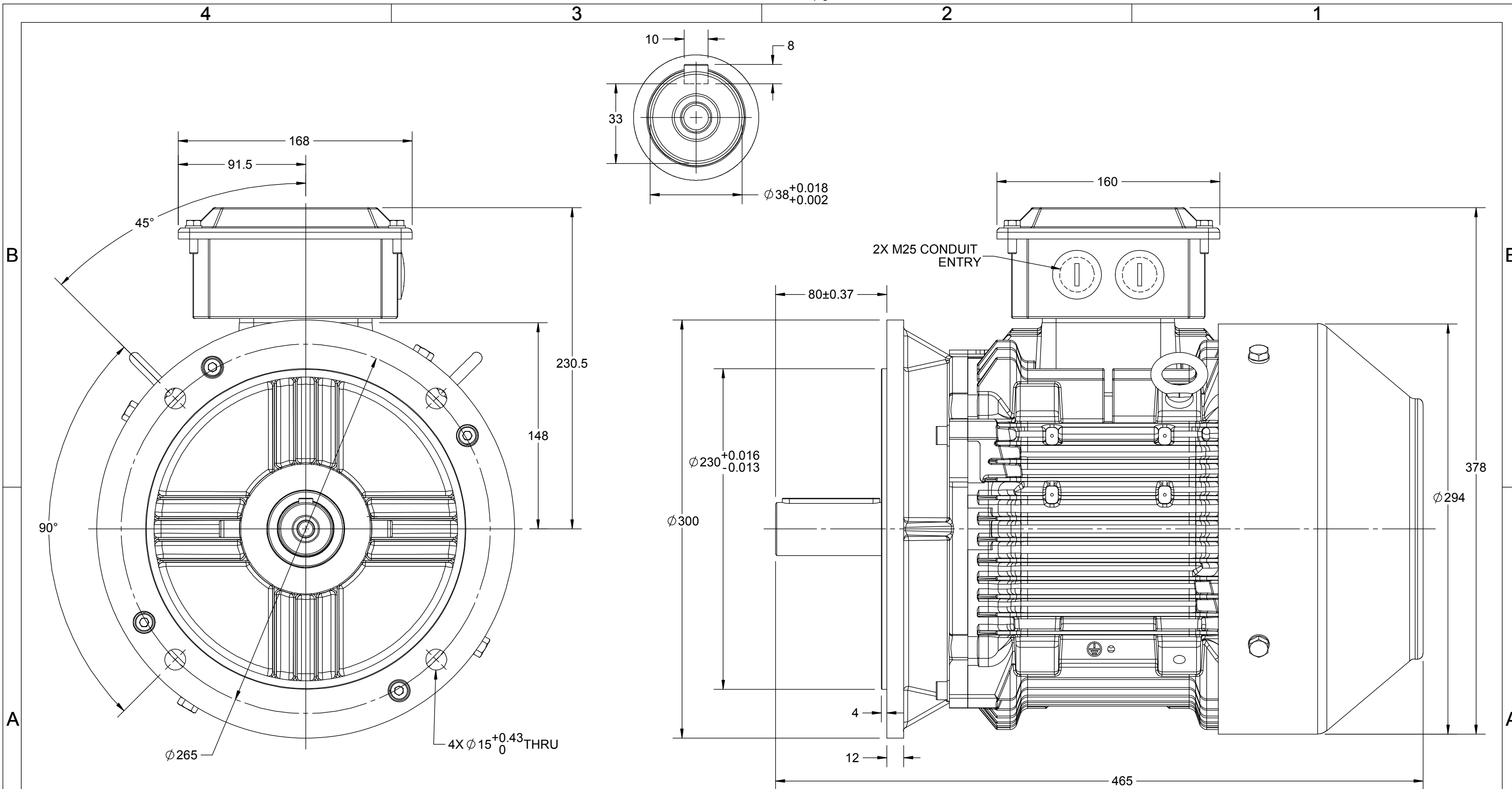

DRAWING REVISION B	REVISION BY LK	DATE 30/05/2019
ECO ECO-0167983	APPROVED BY SR	DATE 30/05/2019
ECO DESCRIPTION MODEL UPDATED AS PER NEW 3D STRUCTURE		
<small>COPYRIGHT REGAL BELOIT AMERICA, INC. ALL RIGHTS RESERVED. PROPRIETARY AND CONFIDENTIAL INFORMATION - THIS DOCUMENT IS THE PROPERTY OF REGAL BELOIT AMERICA, INC. ("OWNER") AND CONTAINS OWNER'S PROPRIETARY INFORMATION. ANY PERSON, CORPORATION OR OTHER FIRM RECEIVING IT IS DEEMED, BY RECEIVING IT, TO AGREE THAT IT, AND/OR ANY PART OF IT, SHALL NOT BE DISCLOSED TO ANY PERSON, CORPORATION OR OTHER ENTITY, DUPLICATED, AND/OR USED, EXCEPT AS EXPRESSLY APPROVED IN WRITING IN ADVANCE BY OWNER. THIS DOCUMENT SHALL BE RETURNED TO OWNER UPON REQUEST. IT MAY BE SUBJECT TO CERTAIN RESTRICTIONS UNDER APPLICABLE EXPORT CONTROL LAWS AND REGULATIONS.</small>		

DRAWN BY PRIYA		
DATE 02/04/2018		
APPROVED BY JAY	DESCRIPTION OUTLINE	
DATE 02/04/2018	132S-FR-B5 MTG. MOTOR TYPE SCA	
REFERENCE	MATERIAL	PROCESS/FINISH
THIRD ANGLE PROJECTION	SIZE B	DRAWING NUMBER 0213201091
		SHEET 1 OF 1

COPYRIGHT REGAL BELOIT AMERICA, INC. ALL RIGHTS RESERVED. UNAUTHORIZED REPRODUCTION OR DISTRIBUTION OF THIS DOCUMENT IS PROHIBITED. REGAL BELOIT AMERICA, INC. ("OWNER") AND CONTAINS OWNER'S PROPRIETARY INFORMATION. ANY PERSON, CORPORATION OR OTHER FIRM RECEIVING IT IS DEEMED, BY RECEIVING IT, TO AGREE THAT IT, AND/OR ANY PART OF IT, SHALL NOT BE DISCLOSED TO ANY PERSON, CORPORATION OR OTHER ENTITY, DUPLICATED, AND/OR USED, EXCEPT AS EXPRESSLY APPROVED IN WRITING IN ADVANCE BY OWNER. THIS DOCUMENT SHALL BE RETURNED TO OWNER UPON REQUEST. IT MAY BE SUBJECT TO CERTAIN RESTRICTIONS UNDER APPLICABLE EXPORT CONTROL LAWS AND REGULATIONS.

DRAWING REVISION A	REVISION BY SN	DATE 13/01/2017
ECO ECO-0116390	APPROVED BY SBD	DATE 13/01/2017
ECO DESCRIPTION NEW DRAWING RELEASE		

GEOMETRIC TOLERANCE		
LINEAR DIM	>0~6	±0.1
	>6~30	±0.2
	>30~120	±0.3

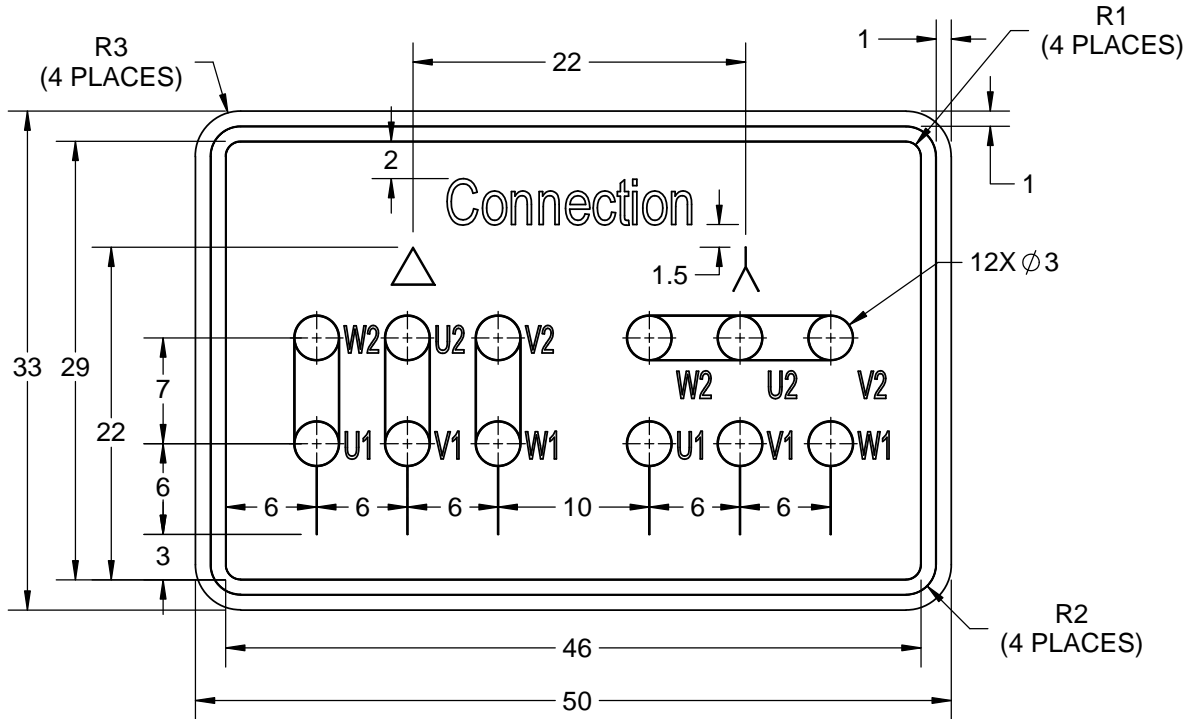



NOTES:

1. PRESSURE-SENSITIVE ADHESIVE COATED PAPER ON THE BACK OF SELF-ADHESIVE.
2. AT THE END OF YELLOW, WORDS, SYMBOLS, LETTERS ARE BLACK, BORDER IS BLACK.
3. THE TOLERANCE OF THE LINEAR SIZE OF THE TOLERANCE WITHOUT THE TOLERANCE BY THE TABLE.

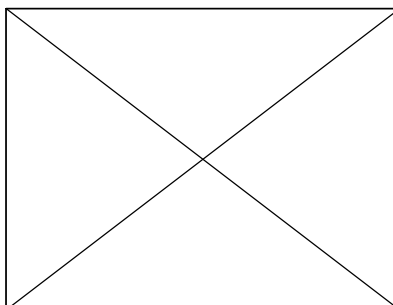
8WD.442.2017



DRAWN BY SN	DATE 16/12/2016		 Regal Beloit America, Inc.
	APPROVED BY SBD		
	DATE 16/12/2016		DESCRIPTION CONN DIAGRAM-NAMEPLATE
	REFERENCE	MATERIAL	PROCESS/FINISH
	THIRD ANGLE PROJECTION 	SIZE A	DRAWING NUMBER 8442000085

Model No. SCA7P51A4121GAA001

U (V)	Δ / Y Conn	f [Hz]	P		I [A]	n [RPM]	T [Nm]	IE Class	% EFF at __ load				PF at __ load			I _A /I _N [pu]	T _A /T _N [pu]	T _K /T _N [pu]
			[kW]	[hp]					5/4FL	FL	3/4FL	1/2FL	FL	3/4FL	1/2FL			
380/660	Δ	50	7.5	10	13.8	2906	24.50	IE2	-	88.1	88.1	88.8	0.94	0.92	0.86	7.8	2.5	3.1

Motor type	SCA	Degree of protection	IP 55
Enclosure	TEFC	Mounting type	IM B5
Frame Material	Cast Iron	Cooling method	IC 411
Frame size	132S	Motor weight - approx.	77 kg
Duty	S1	Gross weight - approx.	80 kg
Voltage variation *	± 10%	Motor inertia	0.0155 kgm ²
Frequency variation *	± 5%	Load inertia	Customer to Provide
Combined variation *	10%	Vibration level	1.6 mm/s
Design	N	Noise level (1meter distance from motor)	68 dB(A)
Service factor	1.0	No. of starts hot/cold/Equally spread	2/3/4
Insulation class	F	Starting method	DOL
Ambient temperature	-20 to +40 °C	Type of coupling	Direct
Temperature rise (by resistance)	80 [Class B] K	LR withstand time (hot/cold)	6/10 s
Altitude above sea level	1000 meter	Direction of rotation	Bi-directional
Hazardous area classification	NA	Standard rotation	Clockwise form DE
Zone classification	NA	Paint shade	RAL 5014
Gas group	NA	Accessories	
Temperature class	NA	Accessory - 1	-
Rotor type	Aluminum Die cast	Accessory - 2	-
Bearing type	Anti-friction ball	Accessory - 3	-
DE / NDE bearing	6308-2Z / 6208-2Z	Terminal box position	TOP
Lubrication method	Greased for life	Maximum cable size/conduit size	1R x 3C x 16mm ² /2 x M25 x 1.5
Type of grease	NA	Auxiliary terminal box	Available on Request

I_A/I_N - Locked Rotor Current / Rated Current

T_K/T_N - Breakdown Torque / Rated Torque

T_A/T_N - Locked Rotor Torque / Rated Torque

NOTE

All performance values at rated voltage and frequency.

All performance parameters are subjected to standard tolerance as per IEC 60034-1

* Voltage, Frequency and combine variation are as per IEC60034-1

Technical data are subject to change. There may be discrepancies between calculated and name plate values.

Efficiency Standards	Europe	China	India	Aus/Nz	Brazil	Global IEC
	-	GB 18613-2012 Grade 2	-	-	-	IEC: 60034-30



Model No. SCA7P51A4121GAA001

Enclosure	U (V)	Δ / Y Conn	f [Hz]	P [kW]	P [hp]	I [A]	n [RPM]	T [kgm]	T [Nm]	IE Class	Amb [°C]	Duty	Elevation [m]	Inertia [kg-m ²]	Weight [kg]
TEFC	380/660	Δ	50	7.5	10	13.8	2906	2.50	24.50	IE2	40	S1	1000	0.0155	77

Motor Load Data

Load Point		NL	1/4FL	1/2FL	3/4FL	FL	5/4FL
Current	A	3.3	4.5	7.1	9.9	13.8	
Torque	Nm	0.0	6.0	12.0	18.2	24.5	
Speed	r/min	3000	2978	2956	2933	2906	
Efficiency	%	0.0	85.0	88.8	88.1	88.1	
Power Factor	%	12.5	69.9	86.0	92.0	94.0	

Performance vs Load Chart

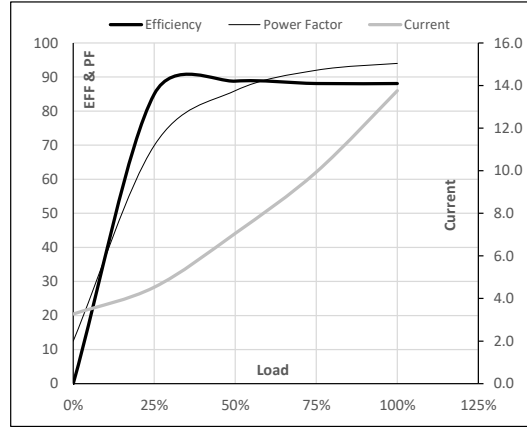

Motor Speed Torque Data

Load Point		LR	P-Up	BD	Rated	NL
Speed	r/min	0	600	2335	2906	3000
Current	A	107.3	96.6	56.8	13.8	3.3
Torque	pu	2.5	2.1	3.1	1	0

Starting Characteristics Chart

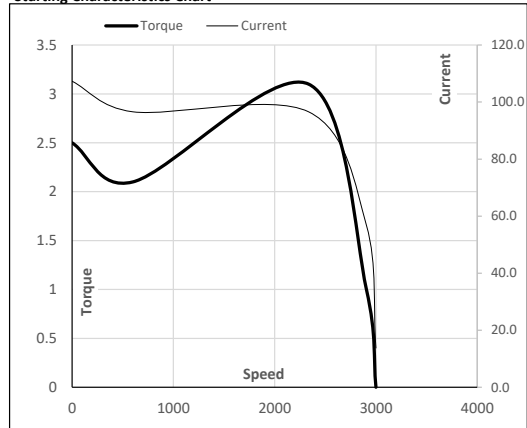

NOTE Refer data sheet for applicable standard and tolerances on performance parameters

Issued By
Issued Date





Model No. SCA7P51A4121GAA001

Enclosure	U (V)	Δ / Y Conn	f [Hz]	P [kW]	P [hp]	I [A]	n [rpm]	T [kgm]	T [Nm]	IE Class	Amb [°C]	Duty	Elevation [m]	Inertia [kg·m ²]	Weight [kg]
TEFC	380/660	Δ	50	7.5	10	13.8	2906	2.50	24.50	IE2	40	S1	1000	0.0155	77

Motor Speed Torque Data

Load	FL	I_1	I_2	I_3	I_4	I_5	LR	
TWT Hot	s 10000	23	16	13	9	8	6	
TWT Cold	s 10000	40	26	20	17	14	10	
Current	pu	1	2	3	4	5	5.5	7.8

Thermal Characteristics Chart

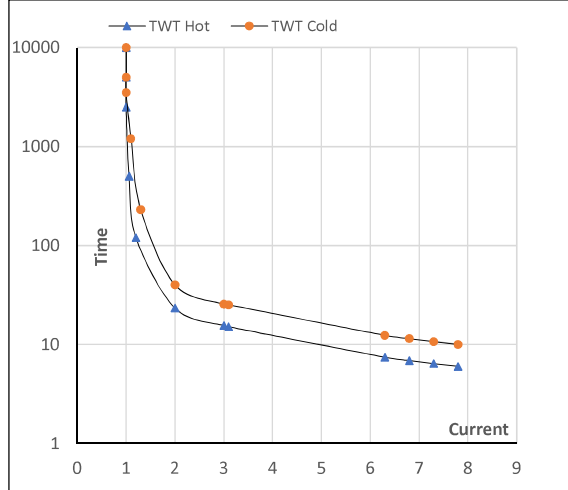

NOTE Refer data sheet for applicable standard and tolerances on performance parameters

Issued By
Issued Date

