

PRODUCT INFORMATION PACKET

Model No: SCA18P2A3131GAAD01

Catalog No: SCA18P2A3131GAAD01

TerraMAX® Cast Iron Motor, 25 HP, 3 Ph, 50 Hz, 415 V, 1500 RPM, 180M Frame, TEFC



Regal and Marathon are trademarks of Regal Rexnord Corporation or one of its affiliated companies.
©2022 Regal Rexnord Corporation, All Rights Reserved. MC017097E



Nameplate Specifications

Output HP	25 Hp	Output KW	18.5 kW
Frequency	50 Hz	Voltage	415 V
Current	32.4 A	Speed	1469 rpm
Service Factor	1	Phase	3
Efficiency	91.2 %	Power Factor	0.87
Duty	S1	Insulation Class	F
Frame	180M	Enclosure	Totally Enclosed Fan Cooled
Thermal Protection	No Protection	Ambient Temperature	50 °C
Drive End Bearing Size	6311	Opp Drive End Bearing Size	6211
UL	No	CSA	No
CE	Yes	IP Code	55
Number of Speeds	1	Efficiency Class	IE2

Technical Specifications

Electrical Type	Squirrel Cage	Starting Method	Direct On Line
Poles	4	Rotation	Bi-Directional
Mounting	B35	Motor Orientation	Horizontal
Drive End Bearing	2z-C3	Opp Drive End Bearing	2z-C3
Frame Material	Cast Iron	Shaft Type	Keyed
Overall Length	712 mm	Frame Length	328 mm
Shaft Diameter	48 mm	Shaft Extension	110 mm
Assembly/Box Mounting	TOP		
Outline Drawing	0218000849	Connection Drawing	8442000085

This is an uncontrolled document once printed or downloaded and is subject to change without notice. Date Created:12/02/2022

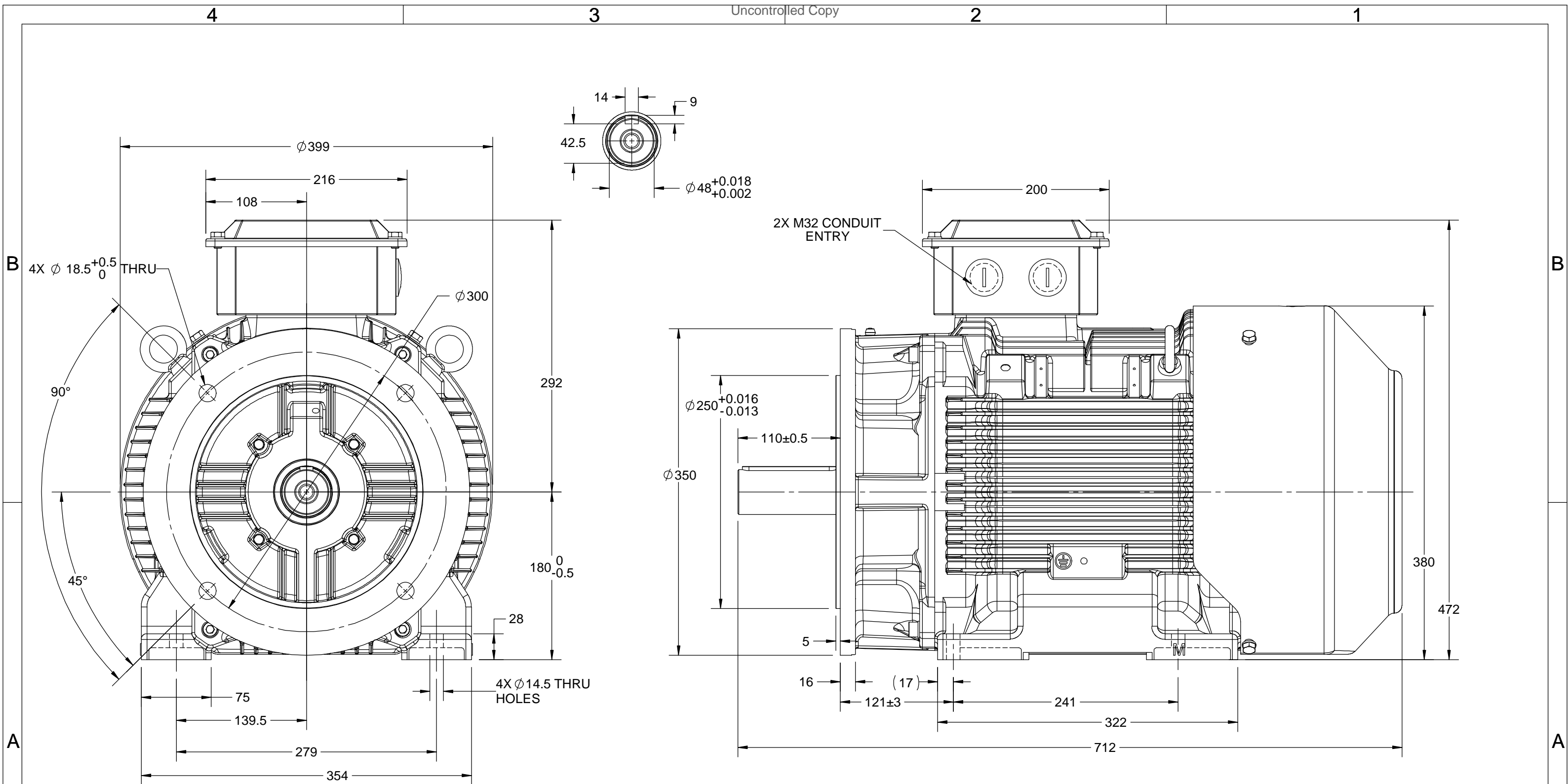

DRAWING REVISION B	REVISION BY VS	DATE 16/08/2018
ECO ECO-0150628	APPROVED BY JAY	DATE 16/08/2018
ECO DESCRIPTION MODEL UPDATED		
<small>COPYRIGHT REGAL BELOIT AMERICA, INC. ALL RIGHTS RESERVED. PROPRIETARY AND CONFIDENTIAL INFORMATION - THIS DOCUMENT IS THE PROPERTY OF REGAL BELOIT AMERICA, INC. ("OWNER") AND CONTAINS OWNER'S PROPRIETARY INFORMATION. ANY PERSON, CORPORATION OR OTHER FIRM RECEIVING IT IS DEEMED, BY RECEIVING IT, TO AGREE THAT IT, AND/OR ANY PART OF IT, SHALL NOT BE DISCLOSED TO ANY PERSON, CORPORATION OR OTHER ENTITY, DUPLICATED, AND/OR USED, EXCEPT AS EXPRESSLY APPROVED IN WRITING IN ADVANCE BY OWNER. THIS DOCUMENT SHALL BE RETURNED TO OWNER UPON REQUEST. IT MAY BE SUBJECT TO CERTAIN RESTRICTIONS UNDER APPLICABLE EXPORT CONTROL LAWS AND REGULATIONS.</small>		

DRAWN BY GSR		
DATE 02/04/2018		
APPROVED BY JAY	DESCRIPTION OUTLINE	
DATE 02/04/2018	180M FR-B35 MTG. MOTOR TYPE: SCA	
REFERENCE	MATERIAL	PROCESS/FINISH
THIRD ANGLE PROJECTION	SIZE B	DRAWING NUMBER 0218000849
		SHEET 1 OF 1

COPYRIGHT REGAL BELOIT AMERICA, INC. ALL RIGHTS RESERVED. UNCONTROLLED COPY
 PROPRIETARY AND CONFIDENTIAL INFORMATION - THIS DOCUMENT IS THE PROPERTY OF
 REGAL BELOIT AMERICA, INC. ("OWNER") AND CONTAINS OWNER'S PROPRIETARY
 INFORMATION. ANY PERSON, CORPORATION OR OTHER FIRM RECEIVING IT IS DEEMED,
 BY RECEIVING IT, TO AGREE THAT IT, AND/OR ANY PART OF IT, SHALL NOT BE DISCLOSED
 TO ANY PERSON, CORPORATION OR OTHER ENTITY, DUPLICATED, AND/OR USED, EXCEPT
 AS EXPRESSLY APPROVED IN WRITING IN ADVANCE BY OWNER. THIS DOCUMENT SHALL
 BE RETURNED TO OWNER UPON REQUEST. IT MAY BE SUBJECT TO CERTAIN
 RESTRICTIONS UNDER APPLICABLE EXPORT CONTROL LAWS AND REGULATIONS.

DRAWING REVISION A	REVISION BY SN	DATE 13/01/2017
ECO ECO-0116390	APPROVED BY SBD	DATE 13/01/2017
ECO DESCRIPTION NEW DRAWING RELEASE		

GEOMETRIC TOLERANCE		
LINEAR DIM	>0~6	±0.1
	>6~30	±0.2
	>30~120	±0.3





NOTES:

1. PRESSURE-SENSITIVE ADHESIVE COATED PAPER ON THE BACK OF SELF-ADHESIVE.
2. AT THE END OF YELLOW, WORDS, SYMBOLS, LETTERS ARE BLACK, BORDER IS BLACK.
3. THE TOLERANCE OF THE LINEAR SIZE OF THE TOLERANCE WITHOUT THE TOLERANCE BY THE TABLE.

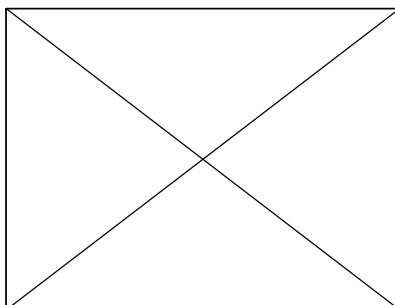
8WD.442.2017



DRAWN BY SN	DATE 16/12/2016		 Regal Beloit America, Inc.	
	APPROVED BY SBD	DESCRIPTION CONN DIAGRAM-NAMEPLATE		
	DATE 16/12/2016	REFERENCE	MATERIAL	PROCESS/FINISH
	THIRD ANGLE PROJECTION 	SIZE A	DRAWING NUMBER 8442000085	SHEET 1 OF 1

Model No. SCA18P2A3131GAAD01

U (V)	Δ / Y Conn	f [Hz]	P		I [A]	n [RPM]	T [Nm]	IE Class	% EFF at __ load				PF at __ load			I _A /I _N [pu]	T _A /T _N [pu]	T _K /T _N [pu]
			[kW]	[hp]					5/4FL	FL	3/4FL	1/2FL	FL	3/4FL	1/2FL			
415	Δ	50	18.5	25	32.4	1469	121.22	IE2	-	91.2	91.2	92.2	0.87	0.84	0.74	5.7	2.2	2.8

Motor type	SCA	Degree of protection	IP 55
Enclosure	TEFC	Mounting type	IM B35
Frame Material	Cast Iron	Cooling method	IC 411
Frame size	180M	Motor weight - approx.	211 kg
Duty	S1	Gross weight - approx.	231 kg
Voltage variation *	± 10%	Motor inertia	0.1527 kgm ²
Frequency variation *	± 5%	Load inertia	Customer to Provide
Combined variation *	10%	Vibration level	2.2 mm/s
Design	N	Noise level (1meter distance from motor)	72 dB(A)
Service factor	1.0	No. of starts hot/cold/Equally spread	2/3/4
Insulation class	F	Starting method	DOL
Ambient temperature	-20 to +50 °C	Type of coupling	Direct
Temperature rise (by resistance)	70 [Class B] K	LR withstand time (hot/cold)	10/20 s
Altitude above sea level	1000 meter	Direction of rotation	Bi-directional
Hazardous area classification	NA	Standard rotation	Clockwise form DE
Zone classification	NA	Paint shade	RAL 5014
Gas group	NA	Accessories	
Temperature class	NA	Accessory - 1	-
Rotor type	Aluminum Die cast	Accessory - 2	-
Bearing type	Anti-friction ball	Accessory - 3	-
DE / NDE bearing	6311-2Z / 6211-2Z	Terminal box position	TOP
Lubrication method	Greased for life	Maximum cable size/conduit size	1R x 3C x 35mm ² /2 X M32 x 1.5
Type of grease	NA	Auxiliary terminal box	NA

I_A/I_N - Locked Rotor Current / Rated Current

T_K/T_N - Breakdown Torque / Rated Torque

T_A/T_N - Locked Rotor Torque / Rated Torque

NOTE

All performance values at rated voltage and frequency.

All performance parameters are subjected to standard tolerance as per IEC 60034-1

* Voltage, Frequency and combine variation are as per IEC60034-1

Technical data are subject to change. There may be discrepancies between calculated and name plate values.

Efficiency Standards	Europe	China	India	Aus/Nz	Brazil	Global IEC
	-	-	IS 12615 : 2018	-	-	-



Model No. SCA18P2A3131GAAD01

Enclosure	U (V)	Δ / Y Conn	f [Hz]	P [kW]	P [hp]	I [A]	n [RPM]	T [kgm]	T [Nm]	IE Class	Amb [°C]	Duty	Elevation [m]	Inertia [kg-m ²]	Weight [kg]
TEFC	415	Δ	50	18.5	25.0	32.4	1469	12.36	121.22	IE2	50	S1	1000	0.1527	211.0

Motor Load Data

Load Point		NL	1/4FL	1/2FL	3/4FL	FL	5/4FL
Current	A	11.2	13.3	19.7	26.2	32.4	
Torque	Nm	0.0	29.8	59.9	90.4	121.2	
Speed	r/min	1500	1493	1485	1477	1469	
Efficiency	%	0.0	89.2	92.2	91.2	91.2	
Power Factor	%	6.1	54.5	74.3	83.5	87.1	

Performance vs Load Chart

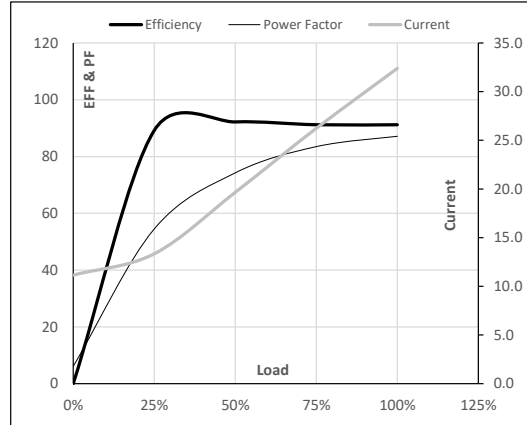

Motor Speed Torque Data

Load Point		LR	P-Up	BD	Rated	NL
Speed	r/min	0	214	1313	1469	1500
Current	A	184.1	165.7	117.6	32.4	11.2
Torque	pu	2.2	1.9	2.8	1	0

Starting Characteristics Chart

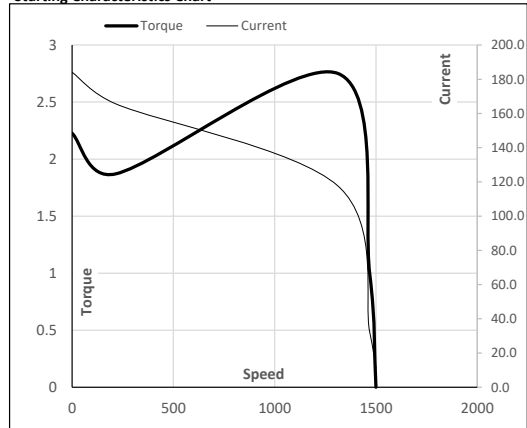

NOTE Refer data sheet for applicable standard and tolerances on performance parameters

Issued By
Issued Date



Model No. SCA18P2A3131GAAD01

Enclosure	U (V)	Δ / Y Conn	f [Hz]	P [kW]	P [hp]	I [A]	n [rpm]	T [kgm]	T [Nm]	IE Class	Amb [°C]	Duty	Elevation [m]	Inertia [kg-m ²]	Weight [kg]
TEFC	415	Δ	50	18.5	25	32.4	1469	12.36	121.22	IE2	50	S1	1000	0.1527	211

Motor Speed Torque Data

Load	FL	I ₁	I ₂	I ₃	I ₄	I ₅	LR
TWT Hot	s 10000	29	19	15	12	11	10
TWT Cold	s 10000	60	38	28	23	22	20
Current	pu	1	2	3	4	5	5.5

Thermal Characteristics Chart

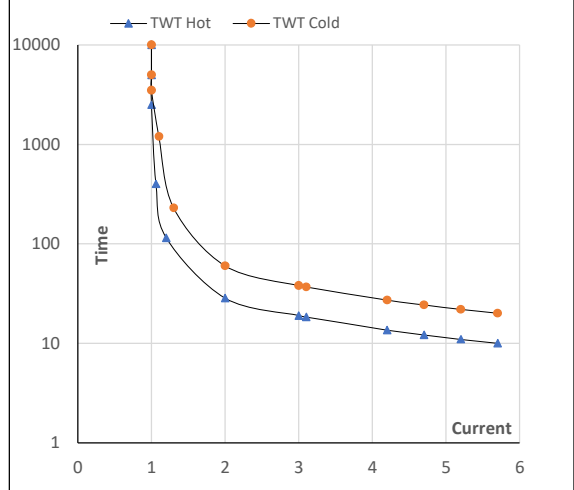

NOTE Refer data sheet for applicable standard and tolerances on performance parameters

Issued By
Issued Date



EC Declaration of Conformity

The undersigned representing
the manufacturer:

Regal Beloit America
100 East Randolph St.
Wausau, WI 54401

and the authorized representative
established within the Community:

Marathon Electric UK
6F Thistleton Road Ind. Estate
Market Overton
Oakham, Rutland LE15 7PP UK

are committed to providing customers with products that comply with applicable regulations and international protocols to which they are subject, including the requirements of the European Parliament Directive on the Harmonization of the laws relating to electrical equipment designed for use within certain voltage limits (2014/35/EU).

Regal Beloit America declares that the following product(s), to which this declaration relates, are in conformity with the relevant sections of the EC standards listed below.

This statement supersedes any statements previously issued pertaining to the product(s) listed below and is subject to change without notice.

Model No : SCA18P2A3131GAAD01

(Model No. may contain prefix and/or suffix characters)

Catalog No : SCA18P2A3131GAAD01

Rework No : N/A

Directives :

Low Voltage Directive 2014/35/EU

Harmonized Standards Used :

EN 60034-1: 2010 (IEC 60034-1: 2010)

EN 60034-5: 2001/A1:2007 (IEC 60034-5: 2000/A1:2006)

Authorized Representative:



Michael A. Logsdon
Vice President, Technology

Authorized Representative in the Community:



Julian Clark
Marketing Engineer

Created on 09/01/2022

CE 22