

PRODUCT INFORMATION PACKET

Model No: QCA1P12A1171GAA001

Catalog No: QCA1P12A1171GAA001

TerraMAX® Cast Iron Motor, 1.50 HP, 3 Ph, 50 Hz, 400 V, 1500 RPM, 90S Frame, TEFC



Regal and Marathon are trademarks of Regal Rexnord Corporation or one of its affiliated companies.

©2022 Regal Rexnord Corporation, All Rights Reserved. MC017097E



Nameplate Specifications

Output HP	1.50 Hp	Output KW	1.1 kW
Frequency	50 Hz	Voltage	400 V
Current	2.4 A	Speed	1451 rpm
Service Factor	1	Phase	3
Efficiency	87.2 %	Power Factor	0.77
Duty	S1	Insulation Class	F
Frame	90S	Enclosure	Totally Enclosed Fan Cooled
Thermal Protection	No Protection	Ambient Temperature	40 °C
Drive End Bearing Size	6205	Opp Drive End Bearing Size	6205
UL	No	CSA	No
CE	Yes	IP Code	55
Number of Speeds	1	Efficiency Class	IE4

Technical Specifications

Electrical Type	Squirrel Cage	Starting Method	Direct On Line
Poles	4	Rotation	Bi-Directional
Mounting	B14A	Motor Orientation	Horizontal
Drive End Bearing	2z-C3	Opp Drive End Bearing	2z-C3
Frame Material	Cast Iron	Shaft Type	Keyed
Overall Length	332 mm	Frame Length	153 mm
Shaft Diameter	24 mm	Shaft Extension	50 mm
Assembly/Box Mounting	Top		
Connection Drawing	8442000085	Outline Drawing	0209000398

This is an uncontrolled document once printed or downloaded and is subject to change without notice. Date Created:12/01/2022

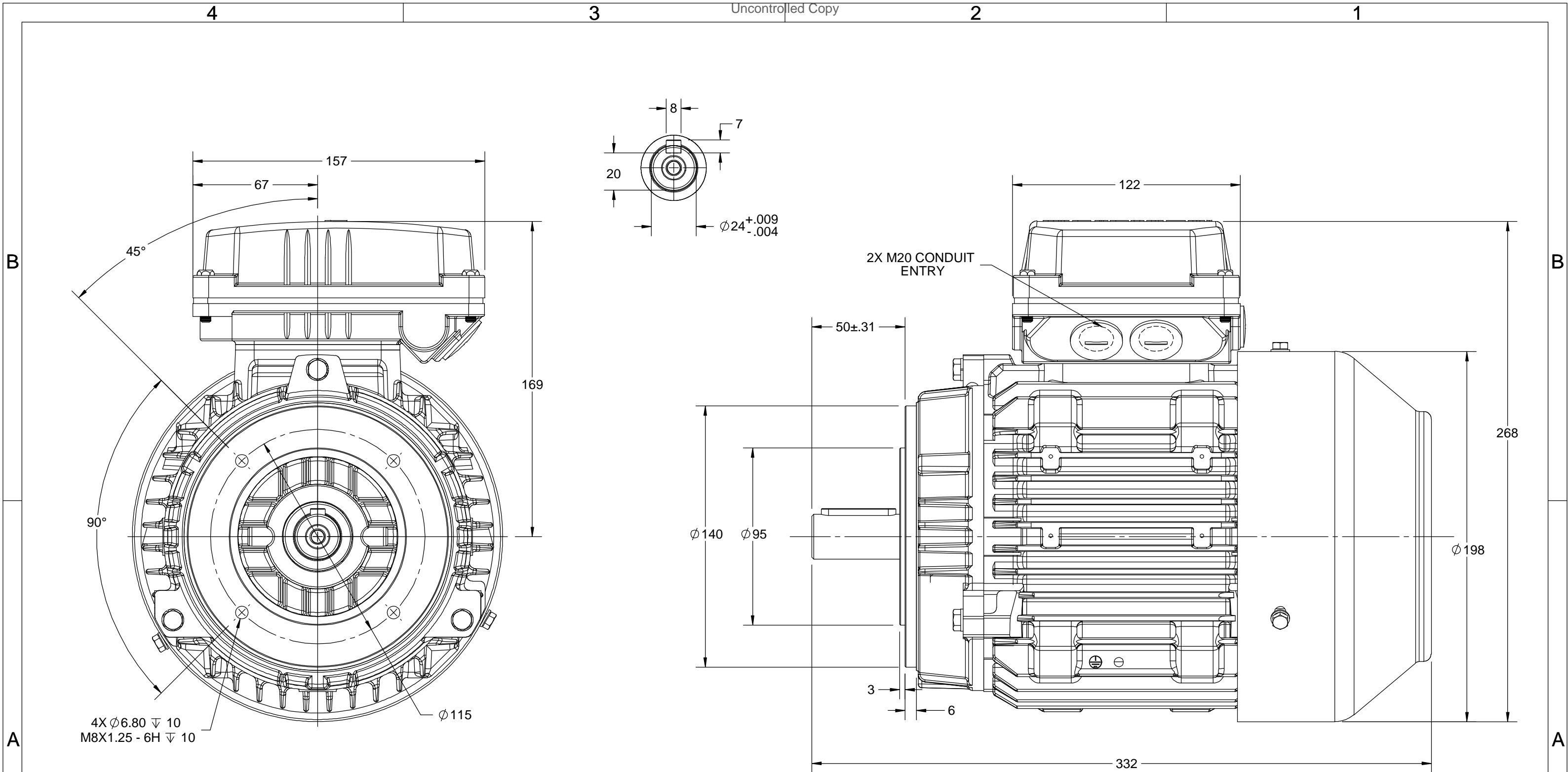

DRAWING REVISION D	REVISION BY I. RAMDAS	DATE 22/06/2018
ECO ECO-0147359	APPROVED BY JAY	DATE 22/06/2018
ECO DESCRIPTION OUTLINE UPDATED AS PER 3D STRUCTURING		
<small>COPYRIGHT REGAL BELOIT AMERICA, INC. ALL RIGHTS RESERVED. PROPRIETARY AND CONFIDENTIAL INFORMATION - THIS DOCUMENT IS THE PROPERTY OF REGAL BELOIT AMERICA, INC. ("OWNER") AND CONTAINS OWNER'S PROPRIETARY INFORMATION. ANY PERSON, CORPORATION OR OTHER FIRM RECEIVING IT IS DEEMED, BY RECEIVING IT, TO AGREE THAT IT, AND/OR ANY PART OF IT, SHALL NOT BE DISCLOSED TO ANY PERSON, CORPORATION OR OTHER ENTITY, DUPLICATED, AND/OR USED, EXCEPT AS EXPRESSLY APPROVED IN WRITING IN ADVANCE BY OWNER. THIS DOCUMENT SHALL BE RETURNED TO OWNER UPON REQUEST. IT MAY BE SUBJECT TO CERTAIN RESTRICTIONS UNDER APPLICABLE EXPORT CONTROL LAWS AND REGULATIONS.</small>		



DRAWN BY SMAR		
DATE 01/09/13		
APPROVED BY JAY	DESCRIPTION OUTLINE	
DATE 01/09/13	90 FR.- B14A MTG. MOTOR TYPE: TCA	
REFERENCE	MATERIAL	PROCESS/FINISH
THIRD ANGLE PROJECTION	SIZE B	DRAWING NUMBER 0209000398
		SHEET 1 OF 1

COPYRIGHT REGAL BELOIT AMERICA, INC. ALL RIGHTS RESERVED. UNAUTHORIZED REPRODUCTION OR DISTRIBUTION OF THIS DOCUMENT IS PROHIBITED. REGAL BELOIT AMERICA, INC. ("OWNER") AND CONTAINS OWNER'S PROPRIETARY INFORMATION. ANY PERSON, CORPORATION OR OTHER FIRM RECEIVING IT IS DEEMED, BY RECEIVING IT, TO AGREE THAT IT, AND/OR ANY PART OF IT, SHALL NOT BE DISCLOSED TO ANY PERSON, CORPORATION OR OTHER ENTITY, DUPLICATED, AND/OR USED, EXCEPT AS EXPRESSLY APPROVED IN WRITING IN ADVANCE BY OWNER. THIS DOCUMENT SHALL BE RETURNED TO OWNER UPON REQUEST. IT MAY BE SUBJECT TO CERTAIN RESTRICTIONS UNDER APPLICABLE EXPORT CONTROL LAWS AND REGULATIONS.

DRAWING REVISION A	REVISION BY SN	DATE 13/01/2017
ECO ECO-0116390	APPROVED BY SBD	DATE 13/01/2017
ECO DESCRIPTION NEW DRAWING RELEASE		

GEOMETRIC TOLERANCE		
LINEAR DIM	>0~6	±0.1
	>6~30	±0.2
	>30~120	±0.3





NOTES:

1. PRESSURE-SENSITIVE ADHESIVE COATED PAPER ON THE BACK OF SELF-ADHESIVE.
2. AT THE END OF YELLOW, WORDS, SYMBOLS, LETTERS ARE BLACK, BORDER IS BLACK.
3. THE TOLERANCE OF THE LINEAR SIZE OF THE TOLERANCE WITHOUT THE TOLERANCE BY THE TABLE.

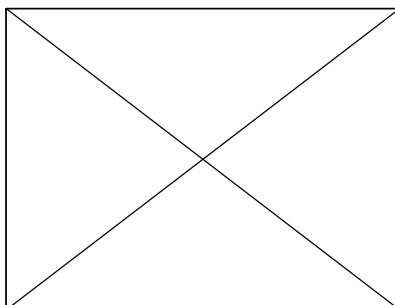
8WD.442.2017



DRAWN BY SN	DATE 16/12/2016		 Regal Beloit America, Inc.	
	APPROVED BY SBD			DESCRIPTION CONN DIAGRAM-NAMEPLATE
	DATE 16/12/2016			
	REFERENCE		MATERIAL	
	THIRD ANGLE PROJECTION 	SIZE A	DRAWING NUMBER 8442000085	SHEET 1 OF 1

Model No. QCA1P12A1171GAA001

U (V)	Δ / Y Conn	f [Hz]	P		I [A]	n [RPM]	T [Nm]	IE Class	% EFF at __ load				PF at __ load			I_A/I_N [pu]	T_A/T_N [pu]	T_K/T_N [pu]
			[kW]	[hp]					5/4FL	FL	3/4FL	1/2FL	FL	3/4FL	1/2FL			
400	Y	50	1.1	1.5	2.4	1451	7.36	IE4	-	87.2	87.2	84.5	0.77	0.69	0.55	7.1	3.0	3.6

Motor type	QCA	Degree of protection	IP 55
Enclosure	TEFC	Mounting type	IM B14A
Frame Material	Cast Iron	Cooling method	IC 411
Frame size	90S	Motor weight - approx.	30 kg
Duty	S1	Gross weight - approx.	31 kg
Voltage variation *	± 10%	Motor inertia	0.0052 kgm ²
Frequency variation *	± 5%	Load inertia	Customer to Provide
Combined variation *	10%	Vibration level	1.6 mm/s
Design	N	Noise level (1meter distance from motor)	54 dB(A)
Service factor	1.0	No. of starts hot/cold/Equally spread	2/3/4
Insulation class	F	Starting method	DOL
Ambient temperature	-20 to +40 °C	Type of coupling	Direct
Temperature rise (by resistance)	80 [Class B] K	LR withstand time (hot/cold)	15/30 s
Altitude above sea level	1000 meter	Direction of rotation	Bi-directional
Hazardous area classification	NA	Standard rotation	Clockwise form DE
Zone classification	NA	Paint shade	RAL 5014
Gas group	NA	Accessories	
Temperature class	NA	Accessory - 1	PTC 150°C
Rotor type	Aluminum Die cast	Accessory - 2	-
Bearing type	Anti-friction ball	Accessory - 3	-
DE / NDE bearing	6205-2Z / 6205-2Z	Terminal box position	TOP
Lubrication method	Greased for life	Maximum cable size/conduit size	1R x 3C x 10mm ² /2 x M20 x 1.5
Type of grease	NA	Auxiliary terminal box	NA

 I_A/I_N - Locked Rotor Current / Rated Current

 T_K/T_N - Breakdown Torque / Rated Torque

 T_A/T_N - Locked Rotor Torque / Rated Torque

NOTE

All performance values at rated voltage and frequency.

All performance parameters are subjected to standard tolerance as per IEC 60034-1

* Voltage, Frequency and combined variation are as per IEC60034-1

Technical data are subject to change. There may be slight variations between calculated values in this datasheet and the motor nameplate figures.

Efficiency Standards	Europe IEC 60034-30-1	China -	India -	Aus/Nz AS/NZ 1359:5:2004	Brazil -	Global IEC IEC 60034-30-1

Model No. QCA1P12A1171GAA001

Enclosure	U (V)	Δ / Y Conn	f (Hz)	P [kW]	P [hp]	I [A]	n [RPM]	T [kgm]	T [Nm]	IE Class	Amb [°C]	Duty	Elevation [m]	Inertia [kg-m ²]	Weight [kg]
TEFC	400	Y	50	1.1	1.5	2.4	1451	0.75	7.36	IE4	40	S1	1000	0.0052	30

Motor Load Data

Load Point		NL	1/4FL	1/2FL	3/4FL	FL	5/4FL
Current	A	1.3	1.4	1.8	2.0	2.4	
Torque	Nm	0.0	1.8	3.6	5.5	7.4	
Speed	r/min	1500	1488	1476	1464	1451	
Efficiency	%	0.0	76.4	84.5	87.2	87.2	
Power Factor	%	8.8	37.4	55.0	69.0	77.0	

Performance vs Load Chart

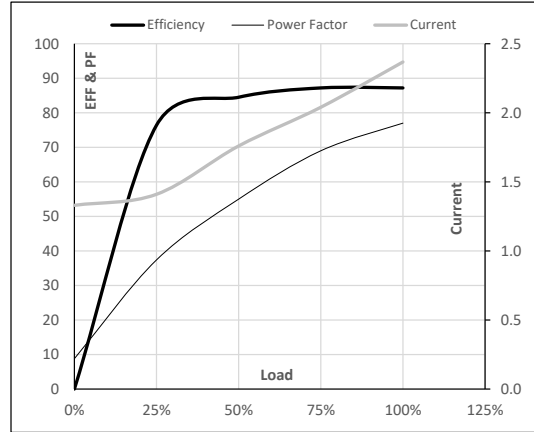

Motor Speed Torque Data

Load Point		LR	P-Up	BD	Rated	NL
Speed	r/min	0	300	1102	1451	1500
Current	A	16.8	15.1	10.2	2.4	1.3
Torque	pu	3.0	2.5	3.6	1	0

Starting Characteristics Chart

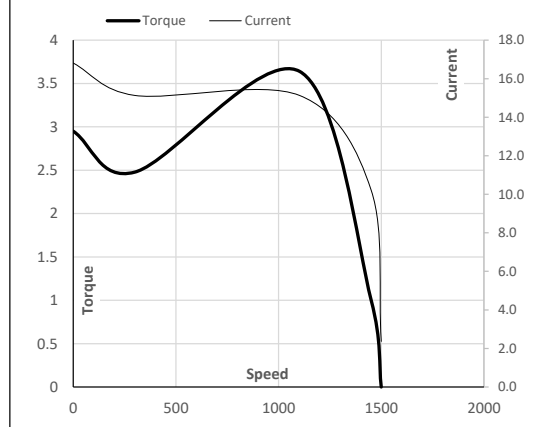

NOTE Refer data sheet for applicable standard and tolerances on performance parameters

Issued By
Issued Date



Model No. QCA1P12A1171GAA001

Enclosure	U (V)	Δ / Y Conn	f [Hz]	P [kW]	P [hp]	I [A]	n [rpm]	T [kgm]	T [Nm]	IE Class	Amb [°C]	Duty	Elevation [m]	Inertia [kg-m ²]	Weight [kg]
TEFC	400	Δ	50	1.1	1.5	2.4	1451	0.75	7.36	IE4	40	S1	1000	0.0052	30

Motor Speed Torque Data

Load	FL	I ₁	I ₂	I ₃	I ₄	I ₅	LR	
TWT Hot	s 10000	53	36	30	25	20	15	
TWT Cold	s 10000	107	71	60	50	40	30	
Current	pu	1	2	3	4	5	5.5	7.1

Thermal Characteristics Chart

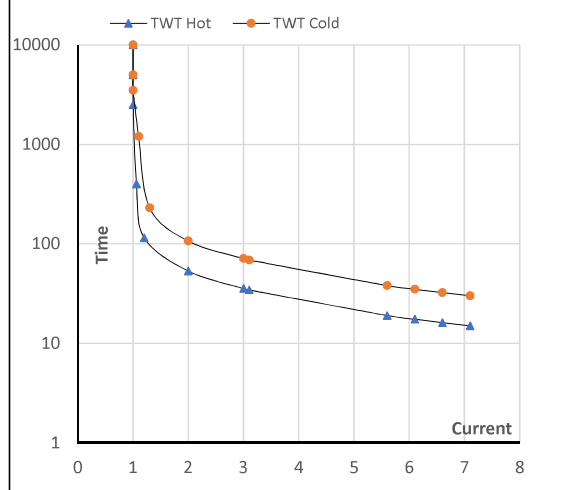

NOTE Refer data sheet for applicable standard and tolerances on performance parameters

Issued By
Issued Date

