

PRODUCT INFORMATION PACKET

Model No: QCA0302A1111GAA001

Catalog No: QCA0302A1111GAA001

TerraMAX® Cast Iron Motor, 40 HP, 3 Ph, 50 Hz, 400 V, 1500 RPM, 200L Frame, TEFC



Regal and Marathon are trademarks of Regal Rexnord Corporation or one of its affiliated companies.

©2022 Regal Rexnord Corporation, All Rights Reserved. MC017097E

Nameplate Specifications

Output HP	40 Hp	Output KW	30.0 kW
Frequency	50 Hz	Voltage	400 V
Current	55.5 A	Speed	1485 rpm
Service Factor	1	Phase	3
Efficiency	94.9 %	Power Factor	0.83
Duty	S1	Insulation Class	F
Frame	200L	Enclosure	Totally Enclosed Fan Cooled
Thermal Protection	No Protection	Ambient Temperature	40 °C
Drive End Bearing Size	6312	Opp Drive End Bearing Size	6212
UL	No	CSA	No
CE	Yes	IP Code	55
Number of Speeds	1	Efficiency Class	IE4

Technical Specifications

Electrical Type	Squirrel Cage	Starting Method	Direct On Line
Poles	4	Rotation	Bi-Directional
Mounting	B3	Motor Orientation	Horizontal
Drive End Bearing	C3	Opp Drive End Bearing	C3
Frame Material	Cast Iron	Shaft Type	Keyed
Overall Length	789 mm	Frame Length	370 mm
Shaft Diameter	55 mm	Shaft Extension	110 mm
Assembly/Box Mounting	Top		
Connection Drawing	8442000085	Outline Drawing	0220000577

This is an uncontrolled document once printed or downloaded and is subject to change without notice. Date Created:12/01/2022

OUTLINE

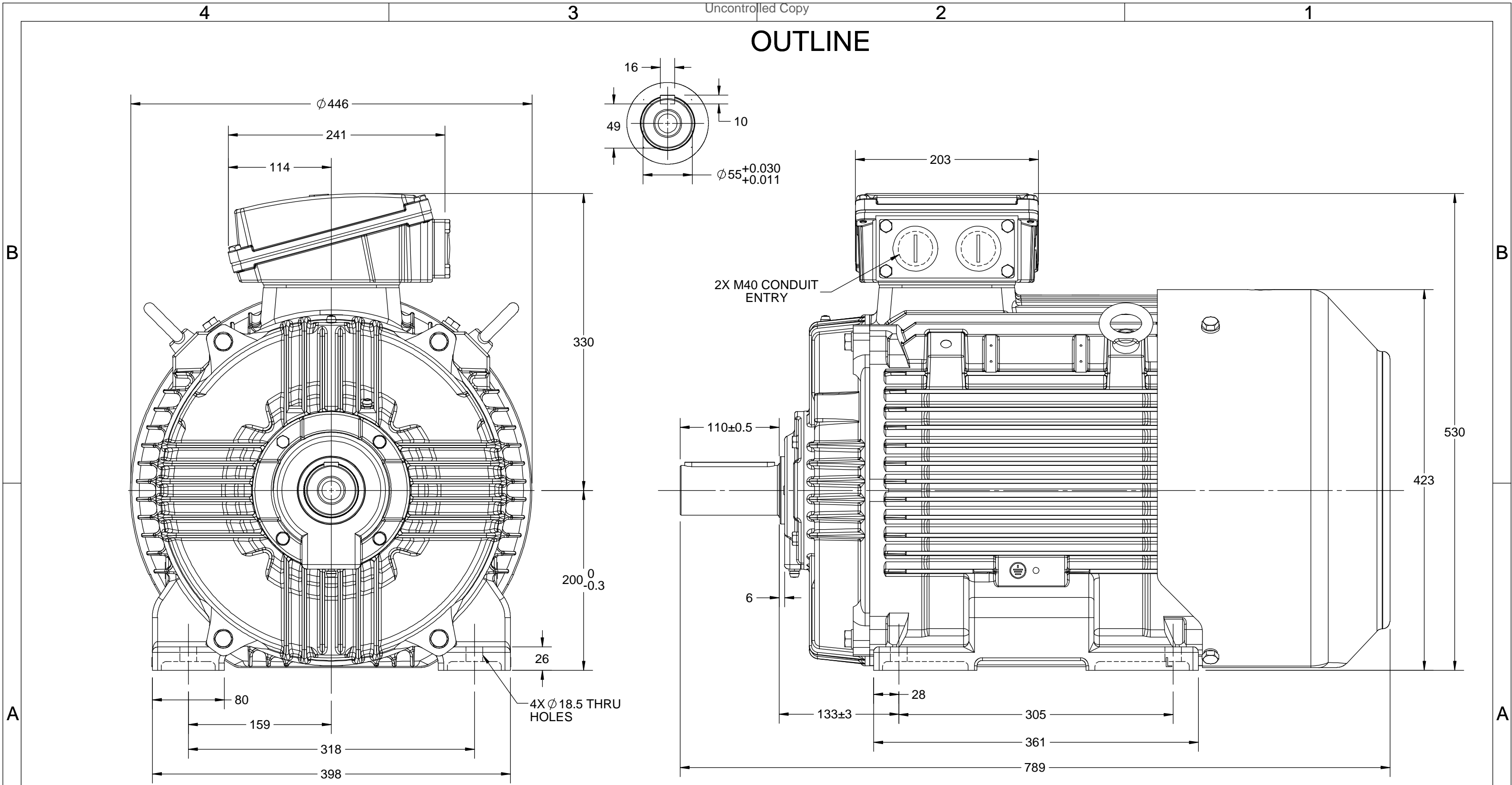

DRAWING REVISION B	REVISION BY GNK	DATE 02/04/2018
ECO ECO-0141751	APPROVED BY JAY	DATE 02/04/2018
ECO DESCRIPTION C DIM UPDATED AS PER STANDARD		
<small>COPYRIGHT REGAL BELOIT AMERICA, INC. ALL RIGHTS RESERVED. PROPRIETARY AND CONFIDENTIAL INFORMATION - THIS DOCUMENT IS THE PROPERTY OF REGAL BELOIT AMERICA, INC. ("OWNER") AND CONTAINS OWNER'S PROPRIETARY INFORMATION. ANY PERSON, CORPORATION OR OTHER FIRM RECEIVING IT IS DEEMED, BY RECEIVING IT, TO AGREE THAT IT, AND/OR ANY PART OF IT, SHALL NOT BE DISCLOSED TO ANY PERSON, CORPORATION OR OTHER ENTITY, DUPLICATED, AND/OR USED, EXCEPT AS EXPRESSLY APPROVED IN WRITING IN ADVANCE BY OWNER. THIS DOCUMENT SHALL BE RETURNED TO OWNER UPON REQUEST. IT MAY BE SUBJECT TO CERTAIN RESTRICTIONS UNDER APPLICABLE EXPORT CONTROL LAWS AND REGULATIONS.</small>		

DRAWN BY NIV		
DATE 06/07/2017		
APPROVED BY JAY	DESCRIPTION OUTLINE	
DATE 06/07/2017	200FR-B3-H/O MTG. MOTOR TYPE: TCA/QCA	
REFERENCE	MATERIAL	PROCESS/FINISH
THIRD ANGLE PROJECTION	SIZE B	DRAWING NUMBER 0220000577
		SHEET 1 OF 1

COPYRIGHT REGAL BELOIT AMERICA, INC. ALL RIGHTS RESERVED. UNAUTHORIZED REPRODUCTION OR DISTRIBUTION OF THIS DOCUMENT IS PROHIBITED. REGAL BELOIT AMERICA, INC. ("OWNER") AND CONTAINS OWNER'S PROPRIETARY INFORMATION. ANY PERSON, CORPORATION OR OTHER FIRM RECEIVING IT IS DEEMED, BY RECEIVING IT, TO AGREE THAT IT, AND/OR ANY PART OF IT, SHALL NOT BE DISCLOSED TO ANY PERSON, CORPORATION OR OTHER ENTITY, DUPLICATED, AND/OR USED, EXCEPT AS EXPRESSLY APPROVED IN WRITING IN ADVANCE BY OWNER. THIS DOCUMENT SHALL BE RETURNED TO OWNER UPON REQUEST. IT MAY BE SUBJECT TO CERTAIN RESTRICTIONS UNDER APPLICABLE EXPORT CONTROL LAWS AND REGULATIONS.

DRAWING REVISION A	REVISION BY SN	DATE 13/01/2017
ECO ECO-0116390	APPROVED BY SBD	DATE 13/01/2017
ECO DESCRIPTION NEW DRAWING RELEASE		

GEOMETRIC TOLERANCE		
LINEAR DIM	>0~6	±0.1
	>6~30	±0.2
	>30~120	±0.3

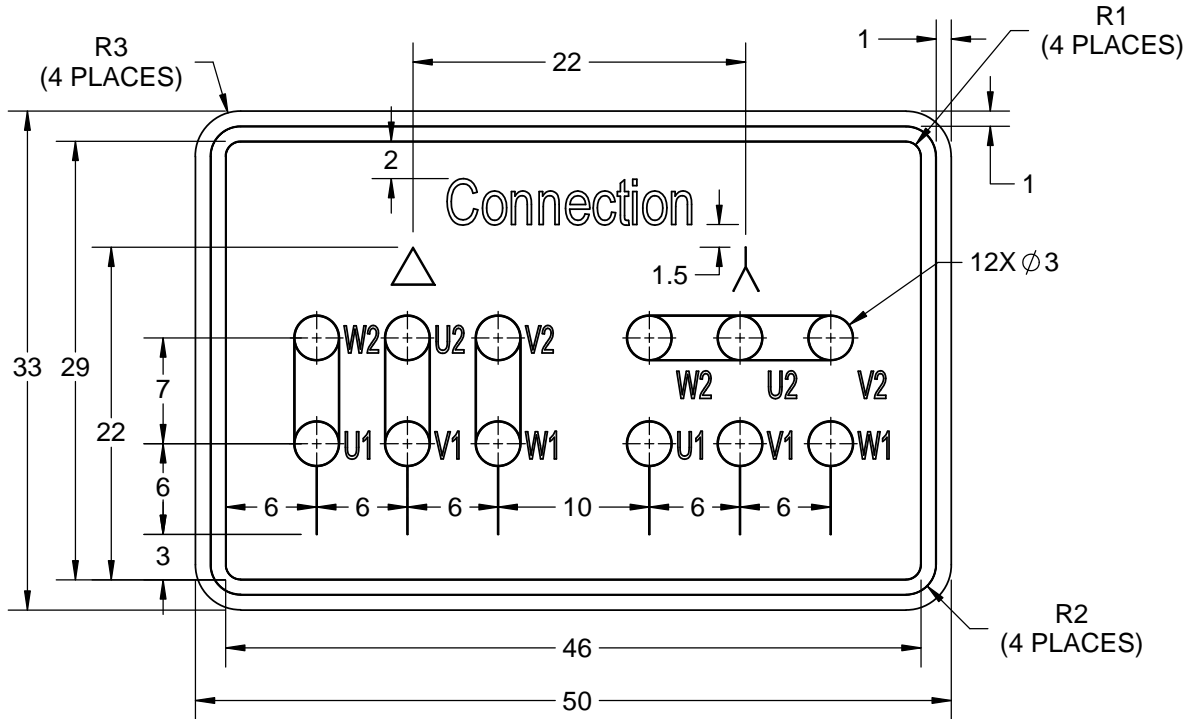



NOTES:

1. PRESSURE-SENSITIVE ADHESIVE COATED PAPER ON THE BACK OF SELF-ADHESIVE.
2. AT THE END OF YELLOW, WORDS, SYMBOLS, LETTERS ARE BLACK, BORDER IS BLACK.
3. THE TOLERANCE OF THE LINEAR SIZE OF THE TOLERANCE WITHOUT THE TOLERANCE BY THE TABLE.

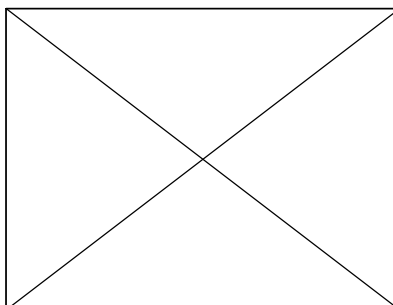
8WD.442.2017



DRAWN BY SN	DATE 16/12/2016		 Regal Beloit America, Inc.	
	APPROVED BY SBD	DESCRIPTION CONN DIAGRAM-NAMEPLATE		
	DATE 16/12/2016	REFERENCE	MATERIAL	PROCESS/FINISH
	THIRD ANGLE PROJECTION 	SIZE A	DRAWING NUMBER 8442000085	SHEET 1 OF 1

Model No. QCA0302A1111GAA001

U (V)	Δ / Y Conn	f [Hz]	P		I [A]	n [RPM]	T [Nm]	IE Class	% EFF at __ load				PF at __ load			I _A /I _N [pu]	T _A /T _N [pu]	T _K /T _N [pu]
			[kW]	[hp]					5/4FL	FL	3/4FL	1/2FL	FL	3/4FL	1/2FL			
400	Δ	50	30	40	55.0	1485	191.79	IE4	-	94.9	94.9	94.1	0.83	0.77	0.64	9.2	3.3	4.1

Motor type	QCA	Degree of protection	IP 55
Enclosure	TEFC	Mounting type	IM B3
Frame Material	Cast Iron	Cooling method	IC 411
Frame size	200L	Motor weight - approx.	317 kg
Duty	S1	Gross weight - approx.	347 kg
Voltage variation *	± 10%	Motor inertia	0.5982 kgm ²
Frequency variation *	± 5%	Load inertia	Customer to Provide
Combined variation *	10%	Vibration level	2.2 mm/s
Design	N	Noise level (1meter distance from motor)	65 dB(A)
Service factor	1.0	No. of starts hot/cold/Equally spread	2/3/4
Insulation class	F	Starting method	DOL
Ambient temperature	-20 to +40 °C	Type of coupling	Direct
Temperature rise (by resistance)	80 [Class B] K	LR withstand time (hot/cold)	15/30 s
Altitude above sea level	1000 meter	Direction of rotation	Bi-directional
Hazardous area classification	NA	Standard rotation	Clockwise form DE
Zone classification	NA	Paint shade	RAL 5014
Gas group	NA	Accessories	
Temperature class	NA	Accessory - 1	PTC 150°C
Rotor type	Aluminum Die cast	Accessory - 2	-
Bearing type	Anti-friction ball	Accessory - 3	-
DE / NDE bearing	6312 C3 / 6212 C3	Terminal box position	TOP
Lubrication method	Regreaseable	Maximum cable size/conduit size	1R x 3C x 50mm ² /2 x M40 x 1.5
Type of grease	CHEVRON SRI-2 or Equivalent	Auxiliary terminal box	NA

I_A/I_N - Locked Rotor Current / Rated Current

T_K/T_N - Breakdown Torque / Rated Torque

T_A/T_N - Locked Rotor Torque / Rated Torque

NOTE

All performance values at rated voltage and frequency.

All performance parameters are subjected to standard tolerance as per IEC 60034-1

* Voltage, Frequency and combined variation are as per IEC60034-1

Technical data are subject to change. There may be slight variations between calculated values in this datasheet and the motor nameplate figures.

Efficiency Standards	Europe IEC 60034-30-1	China -	India -	Aus/Nz AS/NZ 1359:5:2004	Brazil -	Global IEC IEC:60034-30-1



Model No. QCA0302A1111GAA001

Enclosure	U (V)	Δ / Y Conn	f [Hz]	P [kW]	P [hp]	I [A]	n [RPM]	T [kgm]	T [Nm]	IE Class	Amb [°C]	Duty	Elevation [m]	Inertia [kg-m ²]	Weight [kg]
TEFC	400	Δ	50	30	40	55.0	1485	19.56	191.79	IE4	40	S1	1000	0.5982	317

Motor Load Data

Load Point		NL	1/4FL	1/2FL	3/4FL	FL	5/4FL
Current	A	24.4	27.2	36.0	44.8	55.0	
Torque	Nm	0.0	47.6	95.4	143.5	191.8	
Speed	r/min	1500	1496	1493	1489	1485	
Efficiency	%	0.0	90.7	94.1	94.9	94.9	
Power Factor	%	4.2	43.6	64.0	77.0	83.0	

Performance vs Load Chart

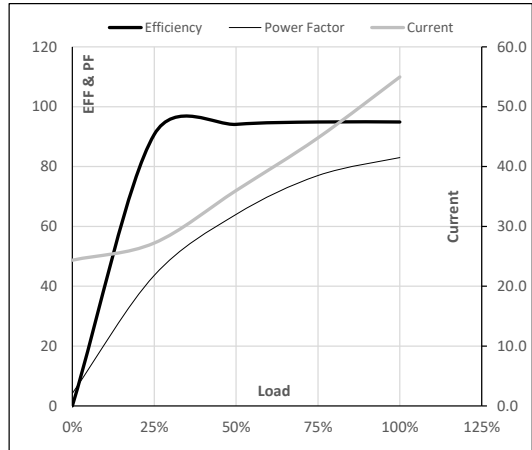

Motor Speed Torque Data

Load Point		LR	P-Up	BD	Rated	NL
Speed	r/min	0	214	1364	1485	1500
Current	A	505.8	455.2	286.0	55.0	24.4
Torque	pu	3.3	2.8	4.1	1	0

Starting Characteristics Chart

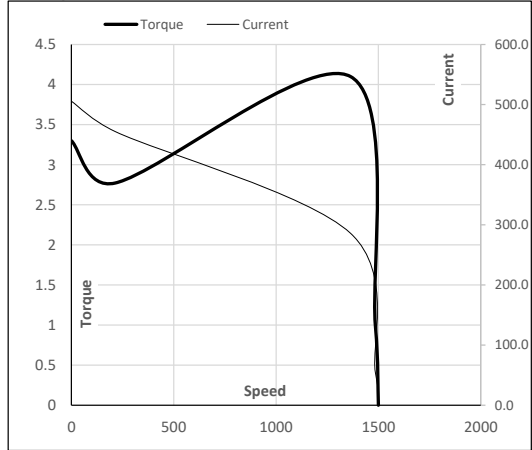

NOTE Refer data sheet for applicable standard and tolerances on performance parameters

Issued By
Issued Date



Model No. QCA0302A1111GAA001

Enclosure	U (V)	Δ / Y Conn	f [Hz]	P [kW]	P [hp]	I [A]	n [rpm]	T [kgm]	T [Nm]	IE Class	Amb [°C]	Duty	Elevation [m]	Inertia [kg-m ²]	Weight [kg]
TEFC	400	Δ	50	30	40	55.0	1485	19.56	191.79	IE4	40	S1	1000	0.5982	317

Motor Speed Torque Data

Load	FL	I ₁	I ₂	I ₃	I ₄	I ₅	LR	
TWT Hot	s 10000	69	46	34	25	20	15	
TWT Cold	s 10000	138	92	70	55	50	30	
Current	pu	1	2	3	4	5	5.5	9.2

Thermal Characteristics Chart

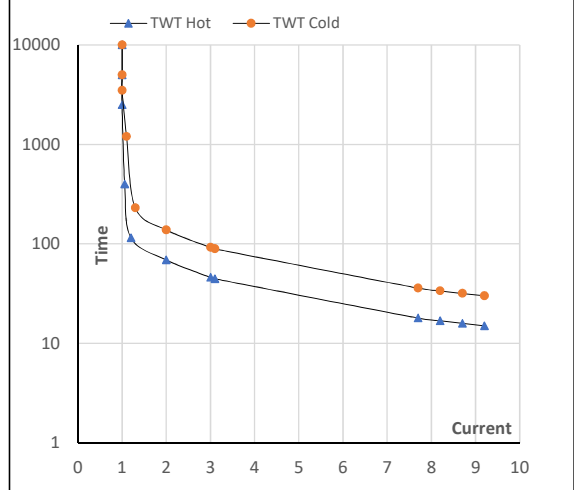

NOTE Refer data sheet for applicable standard and tolerances on performance parameters

Issued By
Issued Date

