

PRODUCT INFORMATION PACKET

Model No: QCA0112AF121GAA001

Catalog No: QCA0112AF121GAA001

TerraMAX® Cast Iron Motor, 15 HP, 3 Ph, 50 Hz, 380 V, 1500 RPM, 160M Frame, TEFC





Nameplate Specifications

Output HP	15 Hp	Output KW	11.0 kW
Frequency	50 Hz	Voltage	380 V
Current	22.5 A	Speed	1479 rpm
Service Factor	1	Phase	3
Efficiency	93.3 %	Power Factor	0.8
Duty	S1	Insulation Class	F
Frame	160M	Enclosure	Totally Enclosed Fan Cooled
Thermal Protection	No Protection	Ambient Temperature	40 °C
Drive End Bearing Size	6309	Opp Drive End Bearing Size	6209
UL	No	CSA	No
CE	YES	IP Code	55
Number of Speeds	1	Efficiency Class	IE4

Technical Specifications

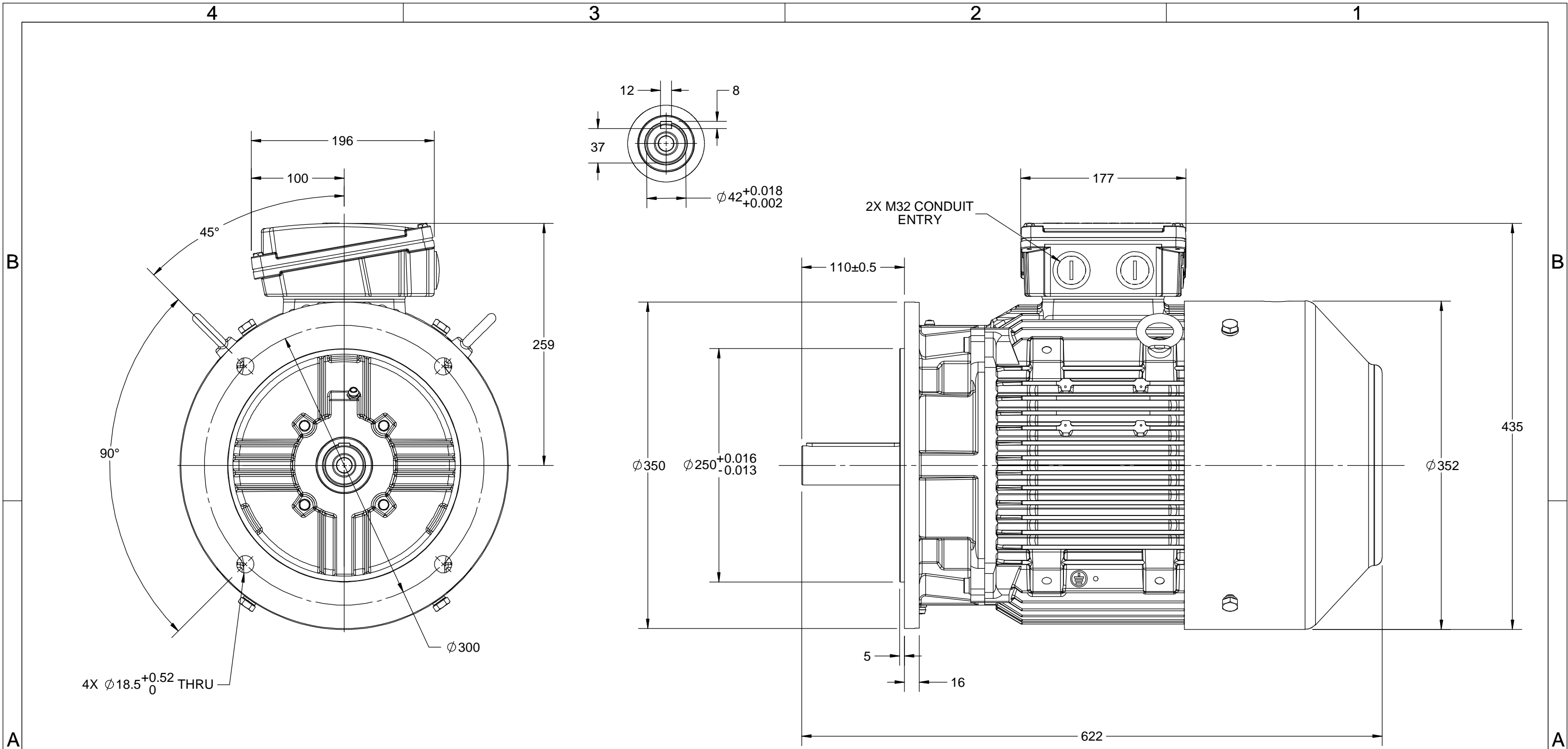

Electrical Type	Squirrel Cage	Starting Method	Direct On Line
Poles	4	Rotation	Bi-Directional
Mounting	B5	Motor Orientation	Horizontal
Drive End Bearing	2z-C3	Opp Drive End Bearing	2z-C3
Frame Material	Cast Iron	Shaft Type	Keyed
Overall Length	622 mm	Frame Length	254 mm
Shaft Diameter	42 mm	Shaft Extension	110 mm
Assembly/Box Mounting	Top		
Outline Drawing	0216000524	Connection Drawing	8442000085

This is an uncontrolled document once printed or downloaded and is subject to change without notice. Date Created:12/01/2022

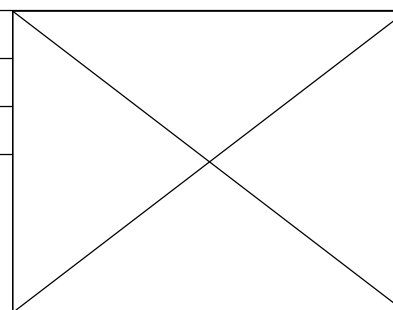

DRAWING REVISION C	REVISION BY S.MUDDA	DATE 3/9/2020
ECO ECO-0190270	APPROVED BY JAY	DATE 3/9/2020
ECO DESCRIPTION CONFIGURATIONS ADDED IN THE 3D MODEL		
<small>COPYRIGHT REGAL BELOIT AMERICA, INC. ALL RIGHTS RESERVED. PROPRIETARY AND CONFIDENTIAL INFORMATION - THIS DOCUMENT IS THE PROPERTY OF REGAL BELOIT AMERICA, INC. ("OWNER") AND CONTAINS OWNER'S PROPRIETARY INFORMATION. ANY PERSON, CORPORATION OR OTHER FIRM RECEIVING IT IS DEEMED, BY RECEIVING IT, TO AGREE THAT IT, AND/OR ANY PART OF IT, SHALL NOT BE DISCLOSED TO ANY PERSON, CORPORATION OR OTHER ENTITY, DUPLICATED, AND/OR USED, EXCEPT AS EXPRESSLY APPROVED IN WRITING IN ADVANCE BY OWNER. THIS DOCUMENT SHALL BE RETURNED TO OWNER UPON REQUEST. IT MAY BE SUBJECT TO CERTAIN RESTRICTIONS UNDER APPLICABLE EXPORT CONTROL LAWS AND REGULATIONS.</small>		



DRAWN BY KCS	 Regal Beloit America, Inc.		
DATE 19/03/2015			
APPROVED BY SBD	DESCRIPTION OUTLINE 160M-2-8P-B5		
DATE 19/03/2015	MATERIAL		
REFERENCE	PROCESS/FINISH		
THIRD ANGLE PROJECTION 	SIZE B	DRAWING NUMBER 0216000524	SHEET 1 OF 1

COPYRIGHT REGAL BELOIT AMERICA, INC. ALL RIGHTS RESERVED. UNAUTHORIZED REPRODUCTION OR DISTRIBUTION OF THIS DOCUMENT IS PROHIBITED. REGAL BELOIT AMERICA, INC. ("OWNER") AND CONTAINS OWNER'S PROPRIETARY INFORMATION. ANY PERSON, CORPORATION OR OTHER FIRM RECEIVING IT IS DEEMED, BY RECEIVING IT, TO AGREE THAT IT, AND/OR ANY PART OF IT, SHALL NOT BE DISCLOSED TO ANY PERSON, CORPORATION OR OTHER ENTITY, DUPLICATED, AND/OR USED, EXCEPT AS EXPRESSLY APPROVED IN WRITING IN ADVANCE BY OWNER. THIS DOCUMENT SHALL BE RETURNED TO OWNER UPON REQUEST. IT MAY BE SUBJECT TO CERTAIN RESTRICTIONS UNDER APPLICABLE EXPORT CONTROL LAWS AND REGULATIONS.

DRAWING REVISION A	REVISION BY SN	DATE 13/01/2017
ECO ECO-0116390	APPROVED BY SBD	DATE 13/01/2017
ECO DESCRIPTION NEW DRAWING RELEASE		

GEOMETRIC TOLERANCE		
LINEAR DIM	>0~6	±0.1
	>6~30	±0.2
	>30~120	±0.3

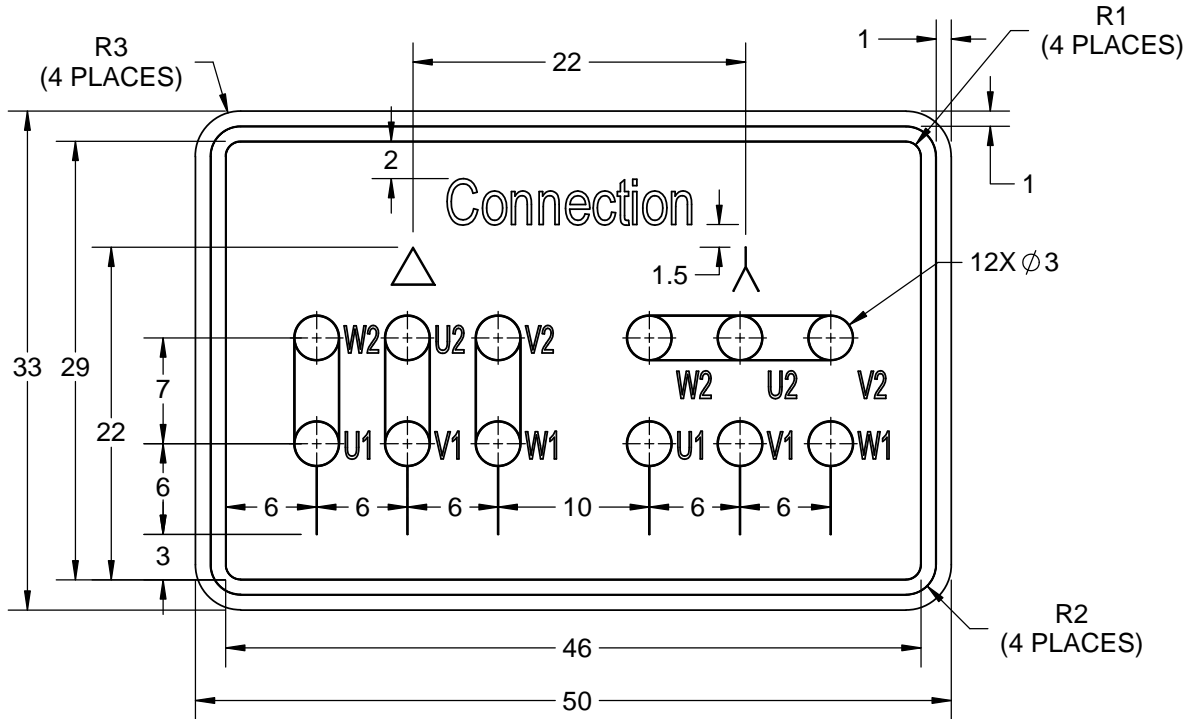



NOTES:

1. PRESSURE-SENSITIVE ADHESIVE COATED PAPER ON THE BACK OF SELF-ADHESIVE.
2. AT THE END OF YELLOW, WORDS, SYMBOLS, LETTERS ARE BLACK, BORDER IS BLACK.
3. THE TOLERANCE OF THE LINEAR SIZE OF THE TOLERANCE WITHOUT THE TOLERANCE BY THE TABLE.

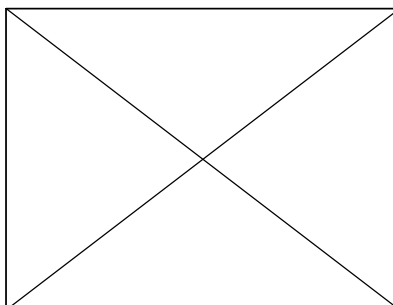
8WD.442.2017



DRAWN BY SN	DATE 16/12/2016		 Regal Beloit America, Inc.
	APPROVED BY SBD		
	DATE 16/12/2016		DESCRIPTION CONN DIAGRAM-NAMEPLATE
	REFERENCE	MATERIAL	PROCESS/FINISH
	THIRD ANGLE PROJECTION 	SIZE A	DRAWING NUMBER 8442000085

Model No. QCA0112AF121GAA001

U (V)	Δ / Y Conn	f [Hz]	P		I [A]	n [RPM]	T [Nm]	IE Class	% EFF at __ load				PF at __ load			I _A /I _N [pu]	T _A /T _N [pu]	T _K /T _N [pu]
			[kW]	[hp]					5/4FL	FL	3/4FL	1/2FL	FL	3/4FL	1/2FL			
380	Δ	50	11	15	22.4	1479	72.22	IE4	-	93.3	93.3	91.2	0.8	0.73	0.59	8.2	3.1	4.0

Motor type	QCA	Degree of protection	IP 55
Enclosure	TEFC	Mounting type	IM B5
Frame Material	Cast Iron	Cooling method	IC 411
Frame size	160M	Motor weight - approx.	163 kg
Duty	S1	Gross weight - approx.	183 kg
Voltage variation *	± 10%	Motor inertia	0.1331 kgm ²
Frequency variation *	± 5%	Load inertia	Customer to Provide
Combined variation *	10%	Vibration level	2.2 mm/s
Design	N	Noise level (1meter distance from motor)	64 dB(A)
Service factor	1.0	No. of starts hot/cold/Equally spread	2/3/4
Insulation class	F	Starting method	DOL
Ambient temperature	-20 to +40 °C	Type of coupling	Direct
Temperature rise (by resistance)	80 [Class B] K	LR withstand time (hot/cold)	15/30 s
Altitude above sea level	1000 meter	Direction of rotation	Bi-directional
Hazardous area classification	NA	Standard rotation	Clockwise form DE
Zone classification	NA	Paint shade	RAL 5014
Gas group	NA	Accessories	
Temperature class	NA	Accessory - 1	PTC 150°C
Rotor type	Aluminum Die cast	Accessory - 2	-
Bearing type	Anti-friction ball	Accessory - 3	-
DE / NDE bearing	6309-2Z / 6209-2Z	Terminal box position	TOP
Lubrication method	Greased for life	Maximum cable size/conduit size	1R x 3C x 35mm ² /2 X M32 x 1.5
Type of grease	NA	Auxiliary terminal box	NA

I_A/I_N - Locked Rotor Current / Rated Current

T_K/T_N - Breakdown Torque / Rated Torque

T_A/T_N - Locked Rotor Torque / Rated Torque

NOTE

All performance values at rated voltage and frequency.

All performance parameters are subjected to standard tolerance as per IEC 60034-1

* Voltage, Frequency and combine variation are as per IEC60034-1

Technical data are subject to change. There may be discrepancies between calculated and name plate values.

Efficiency Standards	Europe	China	India	Aus/Nz	Brazil	Global IEC
	-	GB 18613-2012 Grade 2	-	-	-	IEC: 60034-30



Model No. QCA0112AF121GAA001

Enclosure	U (V)	Δ / Y Conn	f [Hz]	P [kW]	P [hp]	I [A]	n [RPM]	T [kgm]	T [Nm]	IE Class	Amb [°C]	Duty	Elevation [m]	Inertia [kg-m ²]	Weight [kg]
TEFC	380	Δ	50	11	15	22.4	1479	7.36	72.22	IE4	40	S1	1000	0.1331	163

Motor Load Data

Load Point		NL	1/4FL	1/2FL	3/4FL	FL	5/4FL
Current	A	10.9	11.9	15.1	18.1	22.4	
Torque	Nm	0.0	17.9	35.9	54.0	72.2	
Speed	r/min	1500	1495	1490	1485	1479	
Efficiency	%	0.0	85.8	91.2	93.3	93.3	
Power Factor	%	5.8	39.7	59.0	73.0	80.0	

Performance vs Load Chart

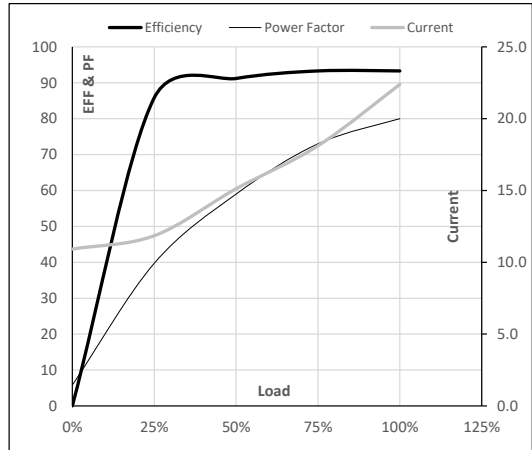

Motor Speed Torque Data

Load Point		LR	P-Up	BD	Rated	NL
Speed	r/min	0	214	1318	1479	1500
Current	A	183.6	165.2	104.3	22.4	10.9
Torque	pu	3.1	2.6	4.0	1	0

Starting Characteristics Chart

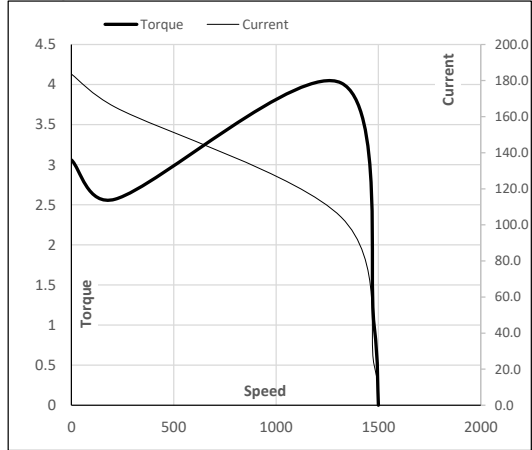

NOTE Refer data sheet for applicable standard and tolerances on performance parameters

Issued By
Issued Date



Model No. QCA0112AF121GAA001

Enclosure	U (V)	Δ / Y Conn	f [Hz]	P [kW]	P [hp]	I [A]	n [rpm]	T [kgm]	T [Nm]	IE Class	Amb [°C]	Duty	Elevation [m]	Inertia [kg-m ²]	Weight [kg]
TEFC	380	Δ	50	11	15	22.4	1479	7.36	72.22	IE4	40	S1	1000	0.1331	163

Motor Speed Torque Data

Load	FL	I ₁	I ₂	I ₃	I ₄	I ₅	LR	
TWT Hot	s 10000	62	41	30	25	20	15	
TWT Cold	s 10000	123	82	60	50	39	30	
Current	pu	1	2	3	4	5	5.5	8.2

Thermal Characteristics Chart

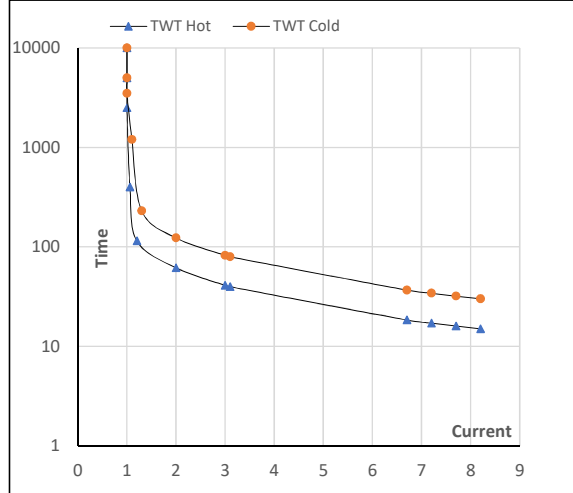

NOTE Refer data sheet for applicable standard and tolerances on performance parameters

Issued By
Issued Date

