

# PRODUCT INFORMATION PACKET



Model No: LM80198  
Catalog No: LM80198

Fire Pump Motor, 200 & 150 HP, 3 Ph, 60 & 50 Hz, 460 & 380 V, 1800 & 1500 RPM, 445TS Frame, TEFC



Regal and Leeson are trademarks of Regal Rexnord Corporation or one of its affiliated companies.  
©2023 Regal Rexnord Corporation, All Rights Reserved. MC017097E





### Nameplate Specifications

Phase	<b>3</b>	Output HP	<b>200 &amp; 150 Hp</b>
Output KW	<b>149.0 &amp; 112.0 kW</b>	Voltage	<b>460 &amp; 380 V</b>
Speed	<b>1785 &amp; 1485 rpm</b>	Service Factor	<b>1.15 &amp; 1.15</b>
Frame	<b>445TS</b>	Enclosure	<b>Totally Enclosed Fan Cooled</b>
Thermal Protection	<b>No Protection</b>	Efficiency	<b>95 &amp; 94.5 %</b>
Ambient Temperature	<b>40 °C</b>	Frequency	<b>60 &amp; 50 Hz</b>
Current	<b>224 &amp; 205 A</b>	Power Factor	<b>88</b>
Duty	<b>Continuous</b>	Insulation Class	<b>F</b>
Design Code	<b>B</b>	KVA Code	<b>G</b>
Drive End Bearing Size	<b>6313</b>	Opp Drive End Bearing Size	<b>6313</b>
UL	<b>No</b>	CSA	<b>Y</b>
CE	<b>Y</b>	IP Code	<b>43</b>
Number of Speeds	<b>1</b>		

### Technical Specifications

Electrical Type	<b>Squirrel Cage Induction Run</b>	Starting Method	<b>Part Wdg Start &amp; Wye Start Delta Run</b>
Poles	<b>4</b>	Rotation	<b>Reversible</b>
Resistance Main	<b>.02 Ohms</b>	Mounting	<b>Rigid Base</b>
Motor Orientation	<b>Horizontal</b>	Drive End Bearing	<b>Ball</b>
Opp Drive End Bearing	<b>Ball</b>	Frame Material	<b>Cast Iron</b>
Shaft Type	<b>TS</b>	Overall Length	<b>39.60 in</b>
Frame Length	<b>20.27 in</b>	Shaft Diameter	<b>2.375 in</b>
Shaft Extension	<b>4.75 in</b>	Assembly/Box Mounting	<b>F1/F2 CAPABLE</b>
Connection Drawing	<b>A-EE7300BH-LN</b>	Outline Drawing	<b>B-SS514023LN-2025</b>

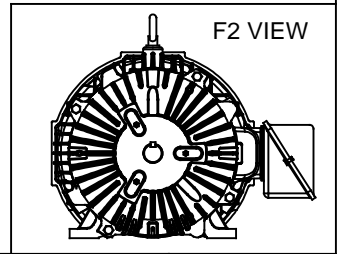
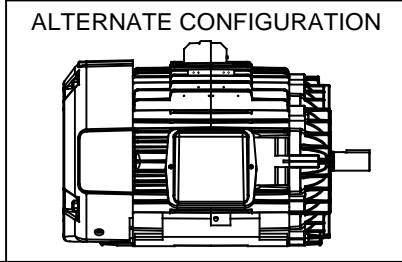
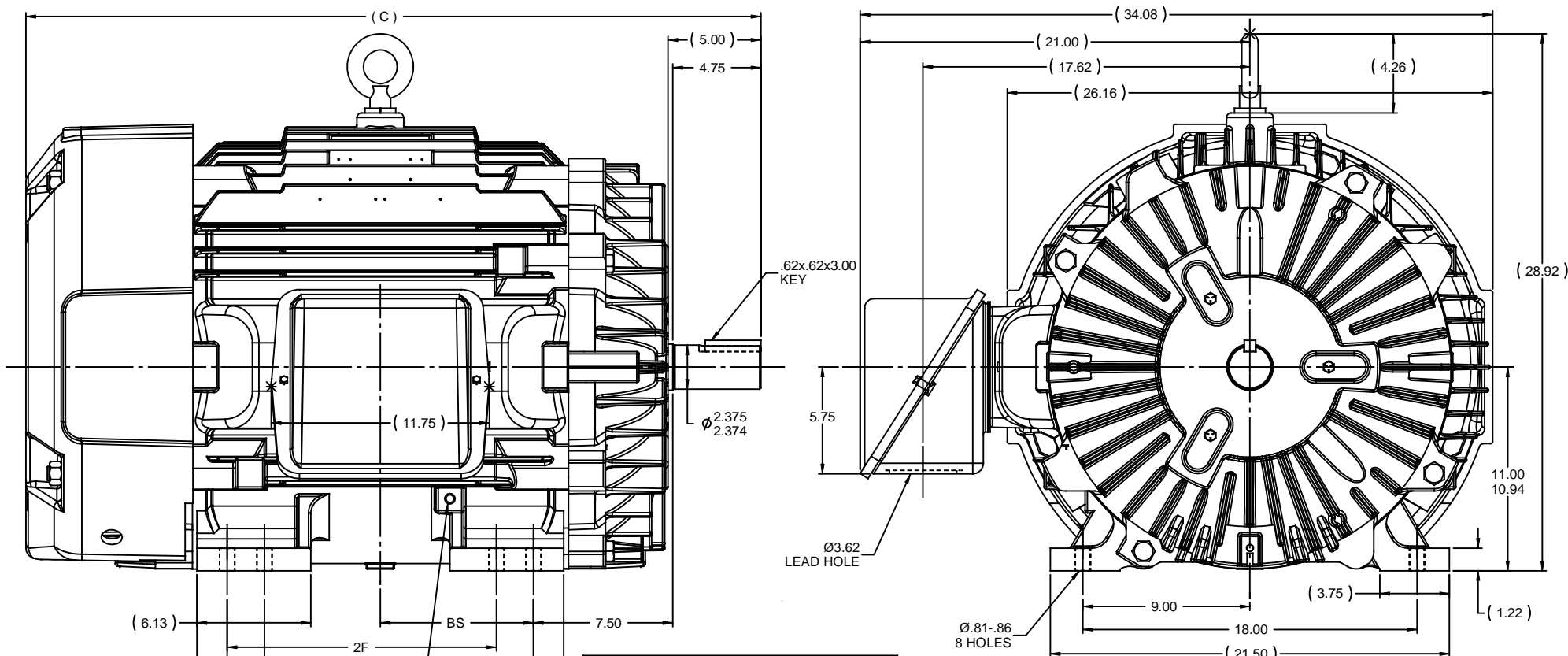

- NOTES:  
 1. CONDUIT BOX CAN BE ROTATED IN 90° STEPS.  
 2. CONDUIT BOX CAN BE MOUNTED ON OPPOSITE SIDE BY REMOVING BRACKETS AND TURNING FRAME 180°.  
 3. NAMEPLATES TO BE READ FROM CONDUIT BOX SIDE OF MOTOR.

DASH	FRAME	B	C	2F	2XF	BS
1825	444TS	17.75	37.60	14.50	---	7.25
2025	444/445TS	19.75	39.60	14.50	16.50	8.25

REVISION		BY & DATE	CHK	ANG	±1/2°	FINISH	PAGE	OF
3	UPDATED WITH NEW FRAME, 28.92 DIMENSION WAS 26.52.	JJB 12/16/2009	MH	XX	±.03	TITLE OUTLINE	1	3
2	CHG. FAN GUARD & REV. C-DIM. PER CN39335	RWR 01/22/2007	ML	XXX	±.005	444/445TS FR. - TEFC - STD.	REF	
1	NEW DRAWING - MU40670	KL 02/22/2002	KL	XXX	±.0005	MATL	FMF	

TOLERANCES UNLESS SPECIFIED		DRAWN		REV	
DEC	INCHES	KL 02-21-2002	JES 02-21-2002	JES 02-21-2002	JES 02-21-2002
x	±.1	APPR	JES 02-21-2002	SCALE	1:5.25
		REF			
		FMF			

NO	REVISION	BY & DATE	CHK	ANG	±1/2°	FINISH	PAGE	OF

SIZE	DRAWING NO	REV
B	SS514023LN	3

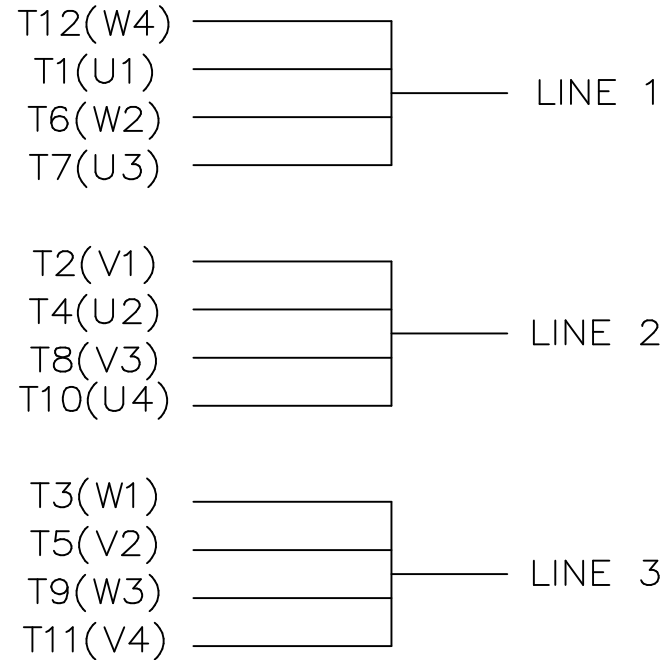
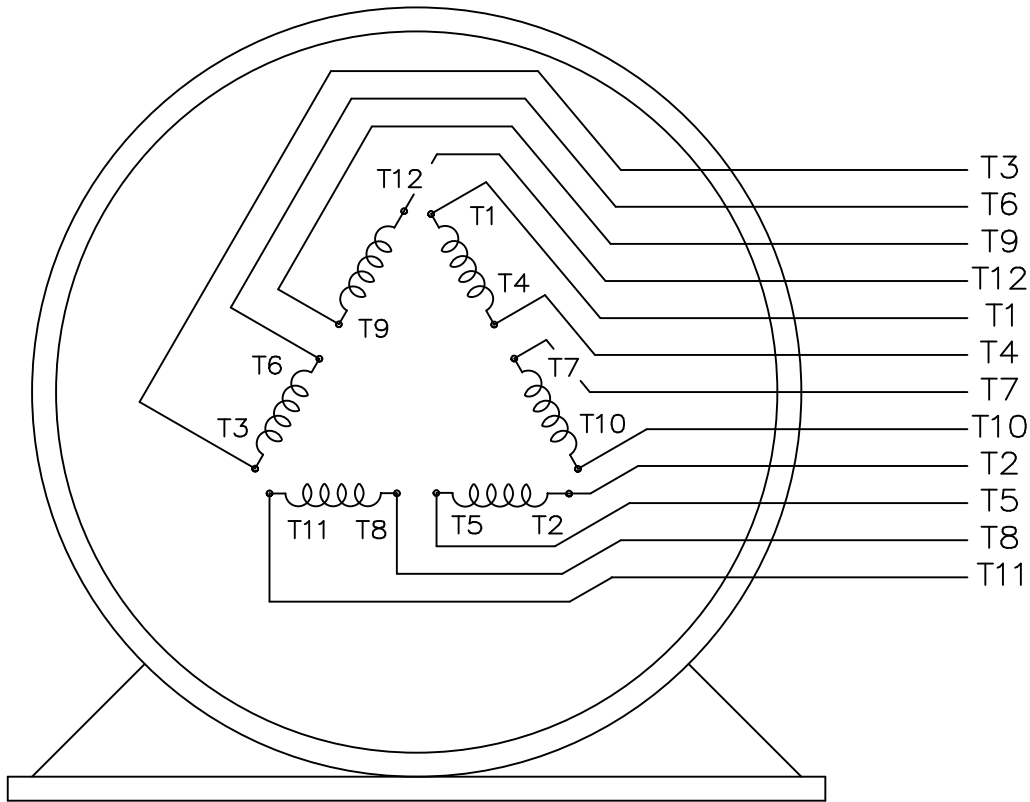

VIEW OF TERMINAL END

				TOLERANCES UNLESS SPECIFIED			DRAWN KL 04-23-2002		
				DEC.	INCHES		CHK DJK 04-24-2002		
				.X	±.1		APPD EAB 04-24-2002		
				.XX	±.01		SCALE 1=1		
2	ADDED IEC TERMINAL MARKINGS	CN 41429	JJB 05/24/2007	OML	.XXX	±.005	TITLE CONNECTION DIAGRAM - EXTERNAL 12 LEAD - SINGLE VOLTAGE		
1	NEW DRAWING	MU41562	KL 04-12-02		.XXXX	±.0005	MAT'L.		
NO.	REVISION		BY & DATE	CHK	ANG	±1/2"	FINISH		
THIS DRAWING IN DESIGN AND DETAIL IS OUR PROPERTY AND MUST NOT BE USED EXCEPT IN CONNECTION WITH OUR WORK ALL RIGHTS OF DESIGN AND INVENTION ARE RESERVED THIS IS AN ELECTRONICALLY GENERATED DOCUMENT - DO NOT SCALE THIS PRINT				RFP	CAD FILE ee7300bh_ln		SIZE	DRAWING NO. PAGE OF	REV.
				DIST	WA-SB		A	EE7300BH-LN 2	2



1051 CHEYENNE AVE.  
GRAFTON, WI 53024  
PH. 262-277-8810

DATA VOLTS: 460

**CERTIFICATION DATA SHEET**

CONN. DIAGRAM: A-EE7300BH-LN  
OUTLINE: B-SS514023LN-2025  
WINDING: T4454206

CAT #: LM80198

NONE 1

**TYPICAL MOTOR PERFORMANCE DATA**

HP	KW	SYNC RPM	FL RPM	FRAME	ENCLOSURE	TYPE	KVA CODE	DESIGN
200	149	1800	1785	445TS	TEFC	TFN	G	B

PH	HZ	VOLTS	AMPS	START TYPE	DUTY	INSL	S.F.	AMB	ELEV.
3	60/50	460#380	224&205	PWS & YDRUN	CONT	F	1.15	40	3300

F.L. EFF	95.0	3/4 LD EFF	95.0	1/2 LD EFF	94.1	GTD EFF	ELECT. TYPE
F.L. PF	88.0	3/4 LD PF	86.0	1/2 LD PF	81.0	94.1	SQ CAGE IND RUN

F.L. TORQUE	LR AMPS @ 460 V	L.R. TORQUE	B.D. TORQUE	F.L. RISE (° C)
589 LB-FT	1,430	950 LB-FT 161%	1,350 LB-FT 229%	75

PRESSURE @ 3	SOUND	POWER	ROTOR WK²	MAX. LOAD WK²	SAFE STALL TIME	STARTS/HOUR	MOTOR WGT
80 dBA	89 dBA		61.0 LB-FT²	1200 LB-FT²	25 SEC.	2	2400 LB.

**\*\*\* SUPPLEMENTAL INFORMATION \*\*\***

DE BRACKET TYPE	ODE BRACKET TYPE	MOUNT TYPE	MOTOR ORIENTATION	SEVERE DUTY	HAZARDOUS LOCATION	DRIP COVER	SCREENS	PAINT
STANDARD	STANDARD	RIGID	HORIZONTAL	NO	NONE	NO	NONE	WATTS AVER

BEARINGS		GREASE	SHAFT TYPE	SPECIAL DE	SPECIAL ODE	SHAFT MATERIAL	FRAME MATERIAL
DE	ODE	POLYREX EM	TS	NONE	NONE	1045 HOT ROLLED (C-204)	CAST IRON
BALL	BALL						
6313	6313						

THERMOSTATS	PROTECTORS	WDG RTD's	BRG RTD's	THERMISTORS	CONTROL	SPACE HEATERS
NONE	NOT	NONE	NONE	NONE	FALSE	NA

R1 (ohms/ph)	R2 (ohms/ph)	X1 (ohms/ph)	X2 (ohms/ph)	Xm (ohms/ph)	VIBRATION (in/sec)	FLOAT
0.017	0.011	0.133	0.145	4.352	0.150	ODE

* N O T E S *	INVERTER TORQUE: NONE INV. HP SPEED RANGE: NONE					
	ENCODER: NONE NONE NONE					
	BRAKE: NONE NONE NONE					
	NONE PPR					
	NONE					

DATE:	9/4/2018	BRAKE: NONE NONE	NONE	NONE
		FT-LB: NA		
		VOLTAGE: NONE		HZ:
		UL: NONE		

Data Sheet

Date: 9/4/2018

LM80198



Data @ **460 V**

Motor Load Data

Load	0%	25%	50%	75%	100%	115%	125%	LR
Current (Amps)	60.0	81.0	123	172	224	257	280	1,430
Torque (ft-lb)	0.00	146	293	440	589	678	737	950
RPM	1800	1795	1792	1788	1785	1,782	1778	0
Efficiency (%)		91.0	94.1	95.0	95.0	95.0	94.5	
P.F. (%)	6.5	63.0	81.0	86.0	88.0	88.0	88.0	28.0

Motor Speed Data

	LR	Pull-Up	BD	Rated	Idle
Speed (RPM)	0	900	1725	1785	1800
Current (Amps)	1,430	1,350	775	224	60.0
Torque (ft-lb)	950	850	1,350	589	0.00

Information Block				
HP	200.0			
Sync. RPM	1800			
Frame	445			
Enclosure	TEFC			
Construction	TFN			
Voltage	460#380 V			
Frequency	60 Hz			
Design	A			
LR Code letter	G			
Service Factor	1.15			
Temp Rise @ FL	75 ° C			
Duty	CONT			
Ambient	40 ° C			
Elevation	1,000 feet			
Rotor/Shaft wk <sup>2</sup>	61.0 Lb-Ft <sup>2</sup>			
Ref Wdg	T4454206 NONE			
Sound Pressure @ 1M	80 dBA			
VFD Rating	NONE			
Outline Dwg	B-SS514023LN-2025			
Conn. Diag	A-EE7300BH-LN			
Additional Specifications:				
0				
0				
EQUIV CKT (OHMS / PHASE)				
R1	R2	X1	X2	Xm
0.0170	0.0110	0.1330	0.1450	4.3520

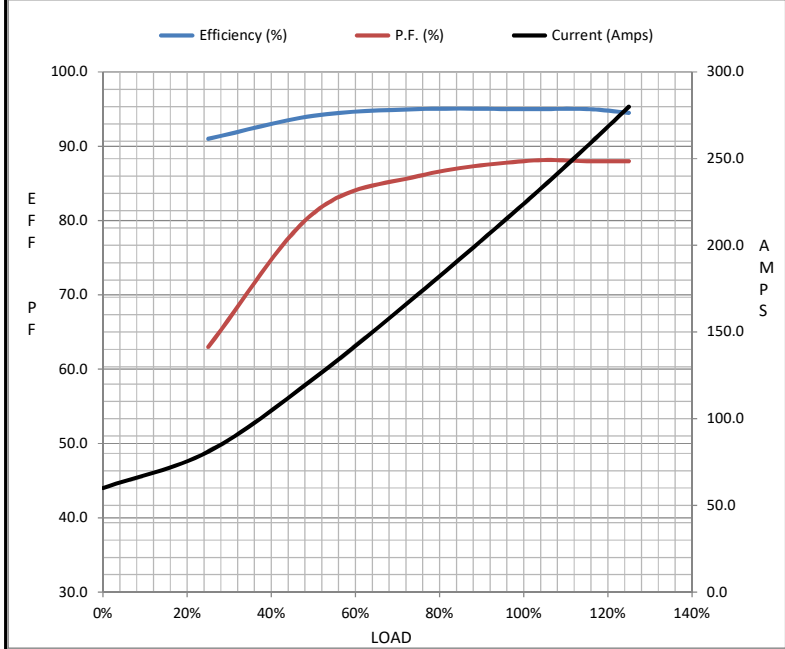

Speed - Torque Curve

