

# PRODUCT INFORMATION PACKET

Model No: E3TN3006283B50D41100

Catalog No: E3TN3006283B50D41100

Made in Italy TCN Series, General Purpose Low Voltage IEC motor, Increased Safety, 45,00 kW,  
3 phase, 989 RPM, D400/Y690V 50Hz, 280S Frame B5, 6 Poles, IC411



Regal and CEMP are trademarks of Regal Rexnord Corporation or one of its affiliated companies.

©2022 Regal Rexnord Corporation, All Rights Reserved. MC017097E

### Nameplate Specifications

Output HP	<b>60 Hp</b>	Output KW	<b>45.0 kW</b>
Frequency	<b>50 Hz</b>	Voltage	<b>400/690 V</b>
Current	<b>84.1 A</b>	Speed	<b>989 rpm</b>
Service Factor	<b>1</b>	Phase	<b>3</b>
Efficiency	<b>93.7 %</b>	Power Factor	<b>0.82</b>
Duty	<b>S1</b>	Insulation Class	<b>F</b>
Frame	<b>280S</b>	Enclosure	<b>Totally Enclosed Fan Cooled</b>
Ambient Temperature	<b>40 °C</b>	Drive End Bearing Size	<b>6317</b>
Opp Drive End Bearing Size	<b>6317</b>	UL	<b>No</b>
CSA	<b>No</b>	CE	<b>Yes</b>
IP Code	<b>IP55</b>	Number of Speeds	<b>1</b>

### Technical Specifications

Electrical Type	<b>Squirrel Cage</b>	Starting Method	<b>Direct On Line</b>
Poles	<b>6</b>	Rotation	<b>Bi-Directional</b>
Mounting	<b>B5</b>	Motor Orientation	<b>Horizontal</b>
Drive End Bearing	<b>C3</b>	Opp Drive End Bearing	<b>C3</b>
Frame Material	<b>Cast Iron</b>	Shaft Type	<b>Keyed</b>
Overall Length	<b>1060.00 mm</b>	Frame Length	<b>549.00 mm</b>
Shaft Diameter	<b>75.000 mm</b>	Shaft Extension	<b>140 mm</b>
Assembly/Box Mounting	<b>Top</b>		
Outline Drawing	<b>B5A04T8285011B01</b>	Connection Drawing	<b>SC-01-T-1v-1a</b>

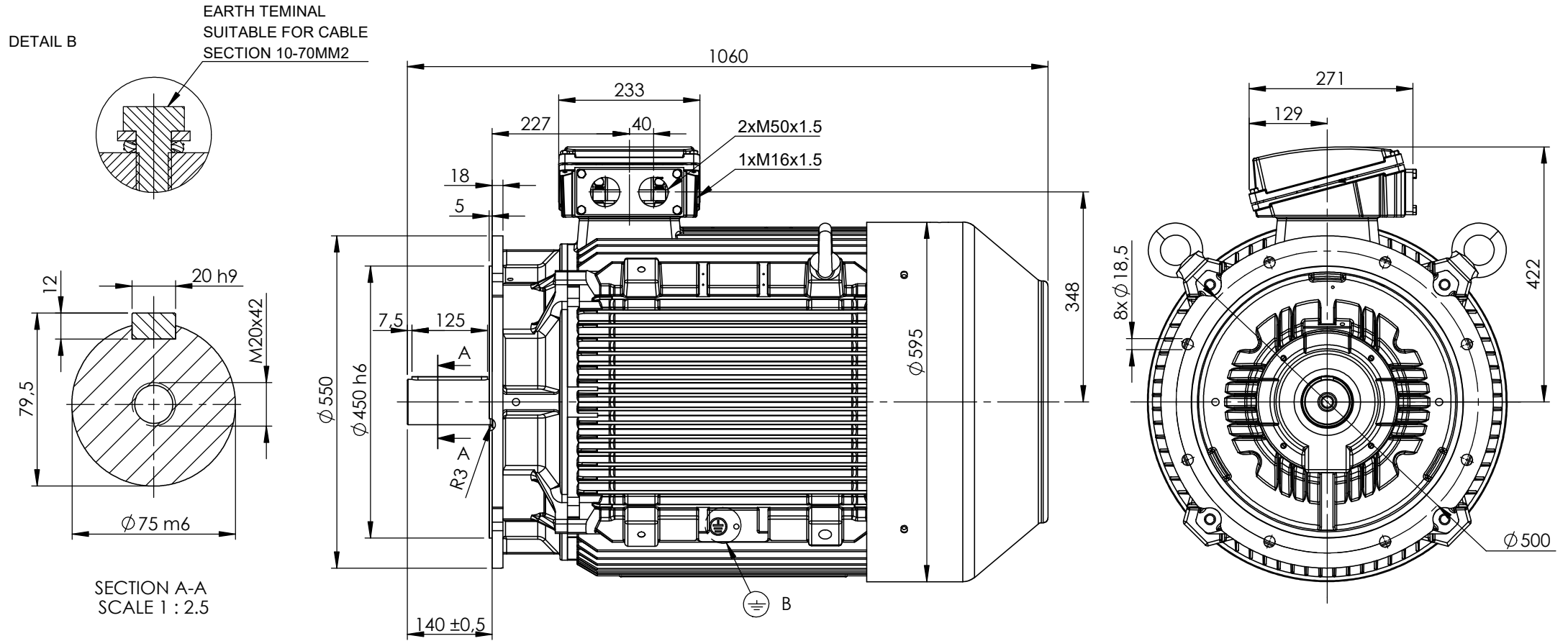

This is an uncontrolled document once printed or downloaded and is subject to change without notice. Date Created:12/02/2022



 Earth terminal: 1 in the terminal box, 2 on the frame.

CUSTOMER REFERENCE AND ADDITIONAL INFORMATION:

MOTOR TYPE AND DESCRIPTION:

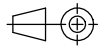
DRAWING REVISION			REVISION BY			DATE			TOLERANCES (EXCEPT AS NOTED)			DRAWN BY			 					
1			TN			12/05/2022			TOLERANCES: ±2			TN								
ECO			APPROVED BY			DATE			* TOLERANCES: ±0.8			DATE			DESCRIPTION <b>Motor 280 4-6P TC (S) B5</b>					
			LP			13/05/2022			DIMENSIONS ARE IN mm ACCORDING TO IEC 60072			26/11/2021								
ECO DESCRIPTION									SERIAL NUMBER			APPROVED BY			DRAWING NUMBER					
COPYRIGHT CEMP Srl. ALL RIGHTS RESERVED. PROPRIETARY AND CONFIDENTIAL INFORMATION - THIS DOCUMENT IS THE PROPERTY OF CEMP Srl. ("OWNER") AND CONTAINS OWNER'S PROPRIETARY INFORMATION. ANY PERSON, CORPORATION OR OTHER FIRM RECEIVING IT IS DEEMED, BY RECEIVING IT, TO AGREE THAT IT, AND/OR ANY PART OF IT, SHALL NOT BE DISCLOSED TO ANY PERSON, CORPORATION OR OTHER ENTITY, DUPLICATED, AND/OR USED, EXCEPT AS EXPRESSLY APPROVED IN WRITING IN ADVANCE BY OWNER. THIS DOCUMENT SHALL BE RETURNED TO OWNER UPON REQUEST. IT MAY BE SUBJECT TO CERTAIN RESTRICTIONS UNDER APPLICABLE EXPORT CONTROL LAWS AND REGULATIONS.												LP						29/11/2021		
												FIRST ANGLE PROJECTION 			A4			1 OF 2		
															B5A04T8285011B01			3 of 11		

Schema di collegamento - *Connection diagram*  
Schemas de branchement - *Schaltplän*  
Esquemas de conexión



DTE 01/01/2004  
SC - 01 - T - 1v.doc

**Motori trifase una velocità - *Single speed, three phase motors* - Moteurs triphasé une vitesse  
*Drehstrommotor Eine Drehzahlstufe* - Motores trifásico una velocidad**



L1 - L2 - L3 = Linea - *Supply* - Reseau - *Netz* - Red  
Per invertire la rotazione invertire due fasi - *To change the rotation reverse two phases* - Pour changer le sens de rotation inverser deux phases - *Zur Drehrichtungsänderung zwei Phasen vertauschen* - Para invertir el sentido de rotación invertir dos fases

<b>Marcatura Morsetti Ausiliari - <i>Additional terminals marking (IEC60034-8)</i></b>		
<b>Marcatura <i>Marking</i></b>	<b>No. morsetti <i>terminals</i></b>	<b>Morsetto ausiliare per: <i>Additional terminal for:</i></b>
TP1A - TP2A (allarme- <i>warning</i> )	2	Termistori PTC (alta velocità) - <i>Thermistor PTC (high speed) [*]</i>
TP1B - TP2B (allarme- <i>warning</i> )	2	Termistori PTC (bassa velocità) - <i>Thermistor PTC (low speed) [*]</i>
R1 - R2 - R3 (I sensore - <i>sensor</i> )	3	Termistore PT100 3 fili - <i>Thermistor PT 100 with 3 wires</i>
R4 - R5 - R6 (II sensore - <i>sensor</i> )	3	
R7 - R8 - R9 (III sensore - <i>sensor</i> )	3	
R11 - R12 - R13 (anteriore - <i>DE</i> )	3	Termistore PT100 su cuscinetto - <i>Thermistor PT 100 on bearing</i>
R21 - R22 - R23 (posteriore - <i>NDE</i> )	3	
TB1 - TB2 (allarme- <i>warning</i> )	2	Protettore bimetallico normalmente chiuso - <i>Normally closed bi-metallic switch (**)</i>
TB3 - TB4 (intervento- <i>switch off</i> )	2	
TB8 - TB9 (intervento- <i>switch off</i> )	2	Protettore bimetallico del freno normalmente chiuso - <i>NC brake bi-metallic switch (**)</i>
TM1 - TM2 (allarme- <i>warning</i> )	2	Protettore bimetallico normalmente aperto - <i>Normally open bi-metallic switch (**)</i>
TM3 - TM4 (intervento- <i>switch off</i> )	2	
HE1- HE2	2	Resistenze riscaldanti - <i>Space heaters</i>
U1 - U2	2	Ventilazione ausiliaria monofase - <i>Single phase forced ventilation</i>
U - V - W	2	Ventilazione ausiliaria trifase - <i>Three phase forced ventilation</i>
colori secondo schema del produttore - <i>colours according manufacturer</i>	9	Encoder
CA1 - CA2	2	Condensatore - <i>Capacitor</i>
PE	1	Conduttore di terra - <i>Earth cable</i>

[\*] U nominale - *U rated* = 6V - max 30V(\*\*) U nominale - *U rated* = 250V

FOGLIO DATI PER MOTORI ELETTRICI ASINCRONI TRIFASI : SERIE IEC  
 DATA SHEET FOR ASYNCHRONOUS THREEPHASE INDUCTION MOTORS: IEC SERIES

Cliente / Customer	-
Offerta / Offer	-
Impianto / Plant	-

## DATI DI PROGETTO - DESIGN DATA

Modo di protezione	II3G	Motore / Frame
Type of protection		Scatola morsetti / Terminal box
Tem. Amb. Min. / Min Amb.Temp.	-20 °C	
Umidità relativa / Relative humidity	90%	
Tensione nominale / Rated Voltage	400 V +/- 10%	

Ex ec IIB T3 Gc	IP55
Ex ec IIB Gc	IP55
Tem. Amb. Max. / Max Amb. Temp.	40 °C
Altitudine / Altitude	< 1000 mslm / masl
Frequenza / Frequency	50 Hz +/- 3%

## DATI FUNZIONALI E COSTRUTTIVI - PERFORMANCE AND CONSTRUCTION DATA

1	Quantità / Quantity		01
2	Motore tipo / Motor type		TCN 280S6
3	Numero di serie / Serial Number		
4	Forma costruttiva / Shape		B5
5	Certificato / Certificate	TÜV IT	20 ATEX 103X
6			
<b>Dati nominali / Rated data</b>			
7	Poli / Pole	n°	6
8	Potenza nominale / Rated power	kW	45,00
9	Corrente nominale / Rated current	A	84,12
10	Velocità nominale / Full Load speed	1/min	989
11	Collegamento / Winding connection		D
12	Isolamento / Insulation class		F
13	Sovratemperatura / Temperature rise		DT80K
14	Raffreddamento / Cooling type		IC411
15	Fattore di servizio / Service factor		1
16			
17	Classe di rendimento / Efficiency level	IEC 34-30	IE3
<b>Performances elettriche / Electrical performances</b>			
	Carico / Load	4/4	3/4
18	Giri / Speed	1/min	989
19	Corr. / Curr.	A	84,12
20	Rend / Eff	%	93,4
21	cos φ	-	0,83
<b>Performances all'avviamento / Starting performances</b>			
22	Ia/In - LRC/FLC	%	600
23	Cosphi a rotore bloccato / LR power factor		0,34
	Tempo a rotore bloccato / LRWT		
24	100% Un (A caldo / Warm)	sec	9
25	(A freddo / Cold)	sec	26
26	80% Un (A caldo / Warm)	sec	14
27	(A freddo / Cold)	sec	40
	Tempo di avviamento ammissibile / ART		
28	100% Un	sec	22
29	80% Un	sec	35
<b>Curva di coppia / Speed-torque values</b>			
30	Coppia nominale / Rated Torque	Nm	434,53
31	Ca/Cn - LRT/FLT	%	170
32	Cmax/Cn - BDT/FLT	%	250
33			
34			
35			
<b>Varie / Other</b>			
36			
37			
38			
39			

<b>Servizio / Duty</b>			
40	Servizio / Duty type	-	S1
41	Intermittenza / Cyclic duration factor	-	-
42	Avviamenti-ora / Starting-hour	-	-
43	Tempo ciclo / Time		-
<b>Cuscinetti / Bearings</b>			
44	Cuscinetto ant / DE bearing	-	6317 C3
45	Cuscinetto post / NDE bearing	-	6317 C3
46	Carico radiale max / Max radial load in X1	N	6506
47	Carico assiale max / Max axial load	N	4655
48	Tipo grasso / Grease type	LGHP2 SKF or equivalent	
49	Intervallo lubrificazione / Lubrication	h	7000
50	Quantità grasso / Quantity grease	gr	38
<b>Caratteristiche meccaniche / mechanical specification</b>			
51	Massa / Mass	kg	599
52	Momento d'inerzia / Moment of inertia	kgm2	2,2340
53	Rumore a vuoto / Noise at no load (1 m)	Lp dB(A)	72
54	Vibrazioni / Vibration level	IEC 34-14	A
55	Limite norma / Vibration limit	mm/sec	2,20
56			
57			
<b>Dati entrata cavi - verniciatura / Cable entry and painting</b>			
63	Entrata cavi / Cable entry	IEC 60423	2xM50+1xM16
64	Ciclo verniciatura / Painting cycle		STD
65	Colore finale / Final colour	RAL	5010
66			
67			
68			
69			
70			
71			
<b>Ausiliari - Auxiliaries</b>			
72	Sonde termiche / Temperature detector	winding	PTC
73	Sonde termiche / Temperature detector	bearing	-
74	Scaldiglie / Heaters	V / W	-
75	Preparation for SPM sensor		-
76	Pressacavi / Cable glands		NO
77			

## Documento preliminare - Preliminary data sheet

**CURVA COPPIA/CORRENTE-GIRI**  
**TORQUE/CURRENT-SPEED DIAGRAM**

Cliente / Customer -  
 Impianto / Plant -  
**ITEM** -  
 Numero d'offerta / Offer Number -

**Motore / Motor** **TCN 280S6**  
 Potenza nominale / Rated power 45,00 kW  
 Poli / Pole 6  
 Tensione - Frequenza / Voltage - Frequency 400 - 50 V - Hz  
 Corrente / Rated current 84,12 A  
 Velocità / Speed 989 rpm  
 Coppia / Torque 434,53 Nm

— COPPIA - TORQUE — CORRENTE - CURRENT

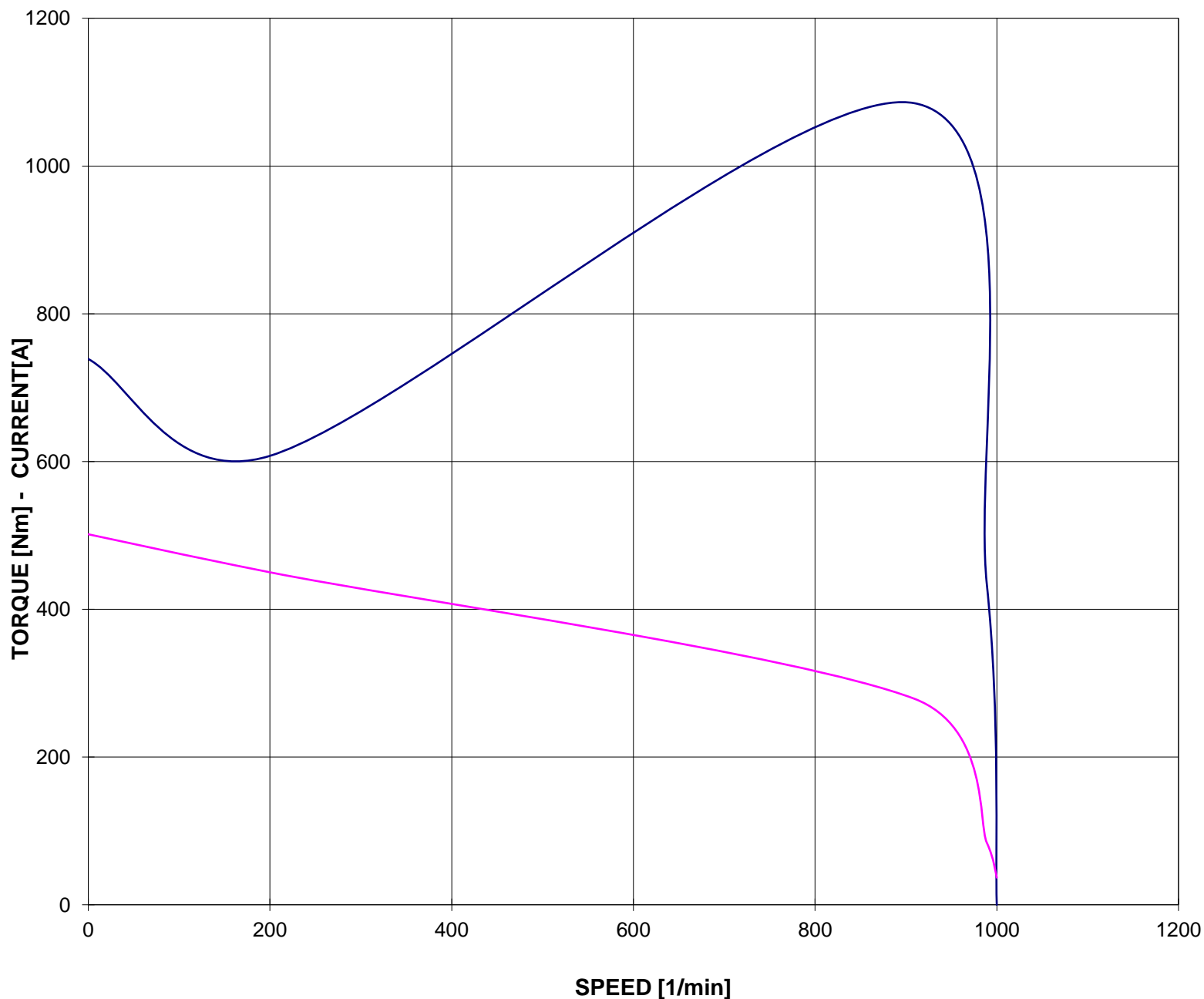

Valori calcolati - Data obtained by calculation method  
 Documento preliminare - Preliminary document

Data / Date 29-giu-22

**CURVA COPPIA/CORRENTE-GIRI (Tensione ridotta)**  
**TORQUE/CURRENT-SPEED DIAGRAM (Reduced voltage)**

Cliente / Customer -  
 Impianto / Plant -  
**ITEM** -  
 Numero d'offerta / Offer Number -

<b>Motore / Motor</b>	<b>TCN 280S6</b>	
Potenza nominale / Rated power	45,00	kW
Poli / Pole	6	
Tensione - Frequenza / Voltage - Frequency	400 - 50	V - Hz
Corrente / Rated current	84,12	A
Velocità / Speed	989	rpm
Coppia / Torque	434,53	Nm

— COPPIA - TORQUE                      — CORRENTE - CURRENT  
 - - - COPPIA - TORQUE 80% Un       - - - CORRENTE - CURRENT 80% Un

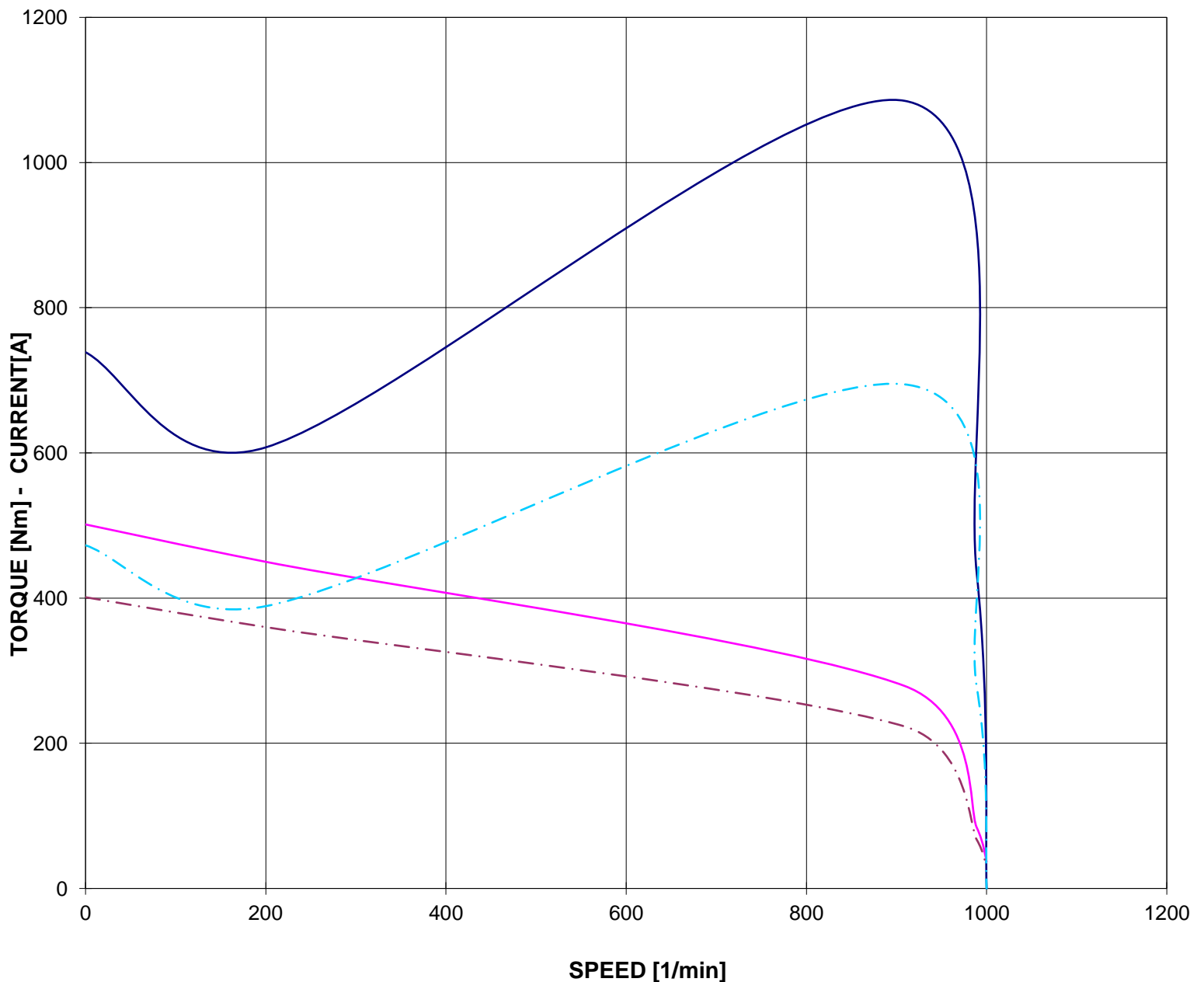

Valori calcolati - Data obtained by calculation method  
 Documento preliminare - Preliminary document

Data / Date 29-giu-22



### CURVE CARATTERISTICHE PERFORMANCE CURVES

Cliente / Customer -  
 Impianto / Plant -  
**ITEM** -  
 Numero d'offerta / Offer Number -

<b>Motore / Motor</b>	<b>TCN 280S6</b>	
Potenza nominale / Rated power	45,00	kW
Poli / Pole	6	
Tensione - Frequenza / Voltage - Frequency	400 - 50	V - Hz
Corrente / Rated current	84,12	A
Velocità / Speed	989	rpm
Coppia / Torque	434,53	Nm

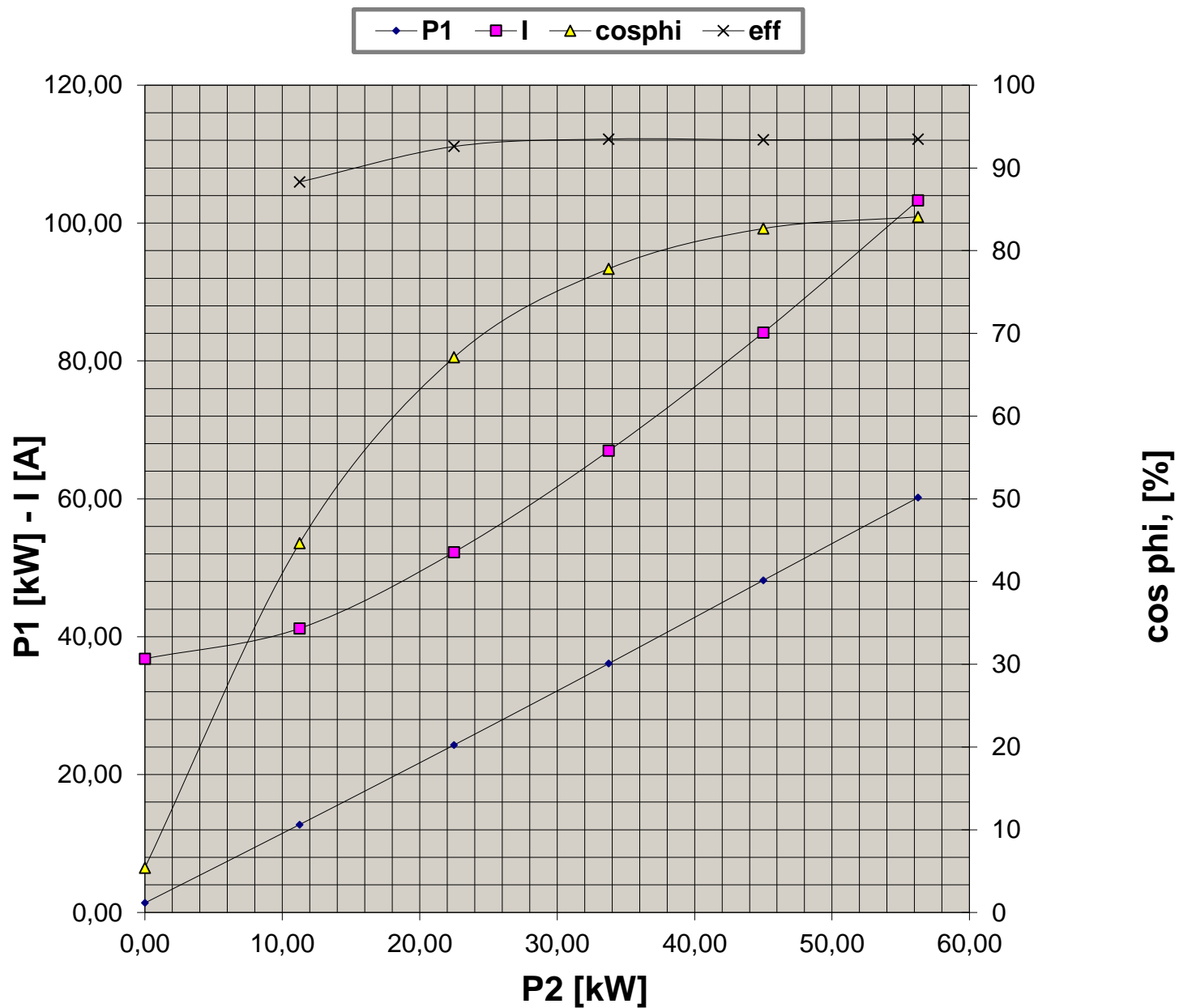

Valori calcolati - Data obtained by calculation method  
 Documento preliminare - Preliminary document

Data / Date 29-giu-22

### CURVA LIMITE CORRENTE TEMPO THERMAL WITHSTAND CURVE

Cliente / Customer -  
 Impianto / Plant -  
**ITEM** -  
 Numero d'offerta / Offer Number -

<b>Motore / Motor</b>	<b>TCN 280S6</b>	
Potenza nominale / Rated power	45,00	kW
Poli / Pole	6	
Tensione - Frequenza / Voltage - Frequency	400 - 50	V - Hz
Corrente / Rated current	84,12	A
Velocità / Speed	989	rpm
Coppia / Torque	434,53	Nm

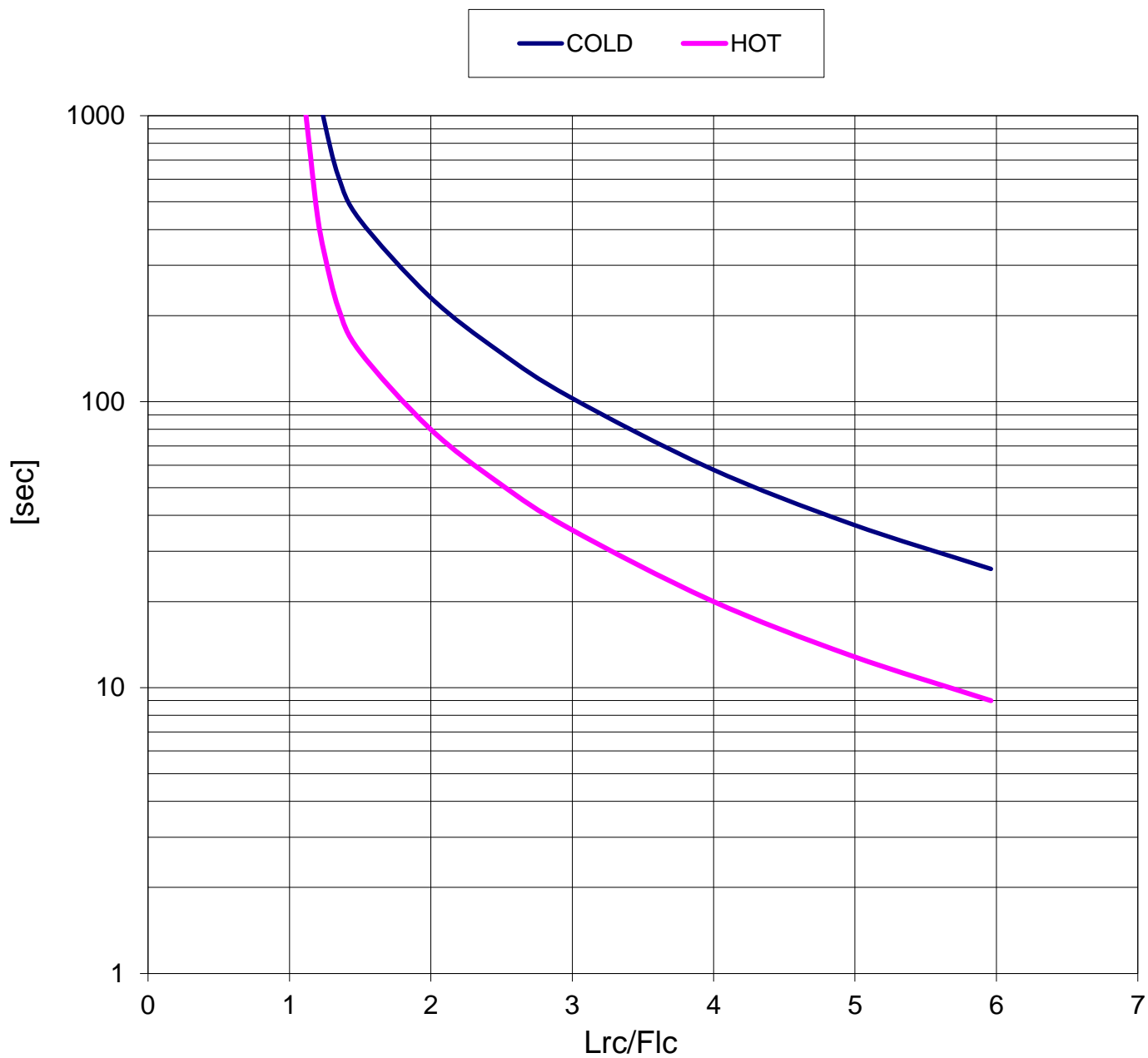

Valori calcolati - Data obtained by calculation method  
 Documento preliminare - Preliminary document

Data / Date 29-giu-22

**CURVA LIMITE CORRENTE TEMPO (Tensione ridotta)**  
**THERMAL WITHSTAND CURVE (Reduced voltage)**

Cliente / Customer -  
 Impianto / Plant -  
**ITEM** -  
 Numero d'offerta / Offer Number -

<b>Motore / Motor</b>	<b>TCN 280S6</b>	
Potenza nominale / Rated power	45,00	kW
Poli / Pole	6	
Tensione - Frequenza / Voltage - Frequency	400 - 50	V - Hz
Corrente / Rated current	84,12	A
Velocità / Speed	989	rpm
Coppia / Torque	434,53	Nm

— COLD (100% Un)    — HOT (100% Un)    - - - COLD (80% Un)    - - - HOT (80% Un)

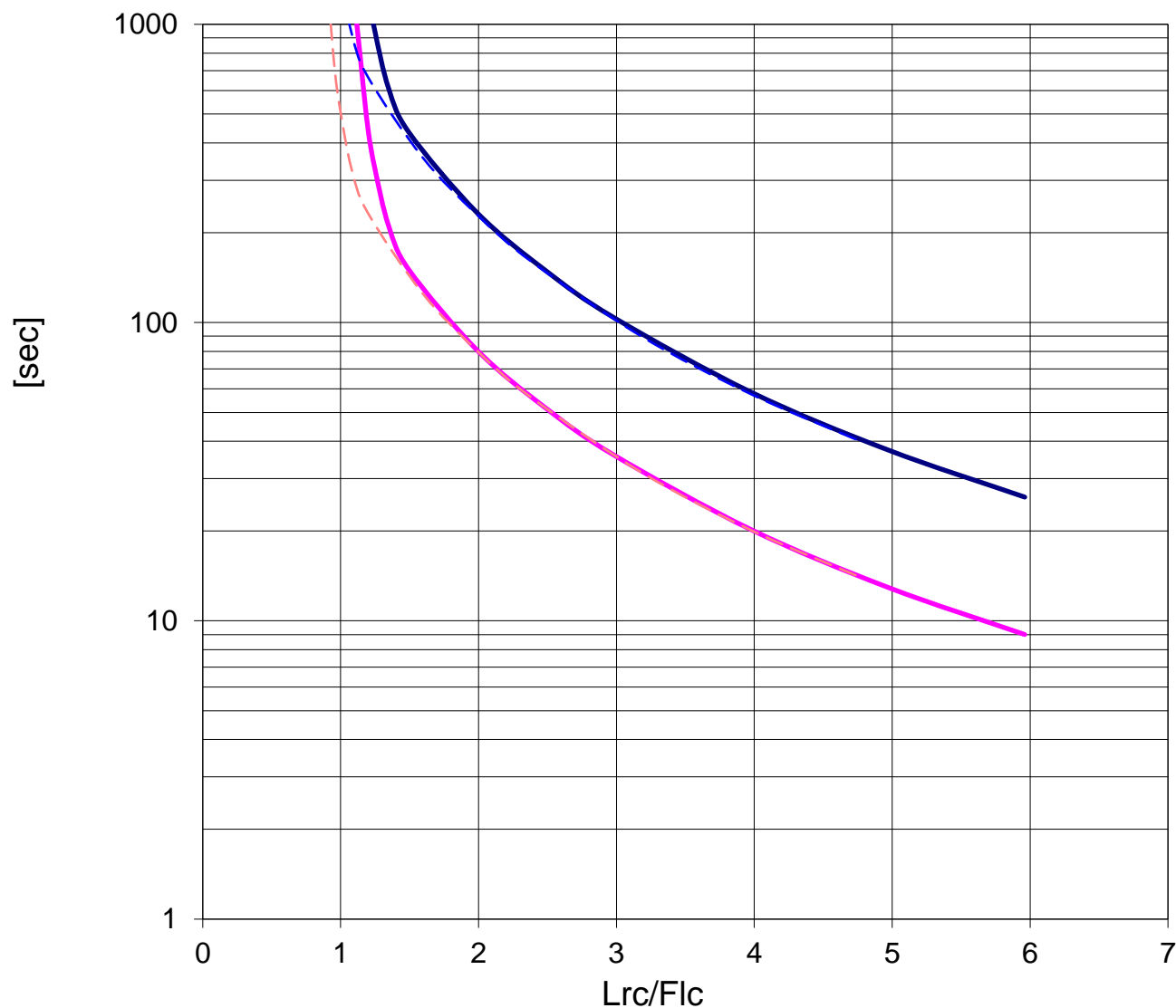

Valori calcolati - Data obtained by calculation method  
 Documento preliminare - Preliminary document

Data / Date 29-giu-22