

PRODUCT INFORMATION PACKET

Model No: E3TI3004317B50D41100

Catalog No: E3TI3004317B50D41100

Made in Italy TCI Series, General Purpose Low Voltage IEC motor, Safe Area, 200,00 kW, 3 phase,
1489 RPM, D400/Y690V 50Hz, 315LC Frame B5, 4 Poles, IC411



Regal and CEMP are trademarks of Regal Rexnord Corporation or one of its affiliated companies.

©2022 Regal Rexnord Corporation, All Rights Reserved. MC017097E

Nameplate Specifications

Output HP	270 Hp	Output KW	200.0 kW
Frequency	50 Hz	Voltage	400/690 V
Current	344.8 A	Speed	1489 rpm
Service Factor	1	Phase	3
Efficiency	96 %	Power Factor	0.87
Duty	S1	Insulation Class	F
Frame	315LC	Enclosure	Totally Enclosed Fan Cooled
Thermal Protection	No Protection	Ambient Temperature	40 °C
Drive End Bearing Size	6319	Opp Drive End Bearing Size	6319
UL	No	CSA	No
CE	Yes	IP Code	IP55
Number of Speeds	1		

Technical Specifications

Electrical Type	Squirrel Cage	Starting Method	Direct On Line
Poles	4	Rotation	Bi-Directional
Mounting	B5	Motor Orientation	Horizontal
Drive End Bearing	C3	Opp Drive End Bearing	C3
Frame Material	Cast Iron	Shaft Type	Keyed
Overall Length	1317.00 mm	Frame Length	840.00 mm
Shaft Diameter	80.000 mm	Shaft Extension	170 mm
Assembly/Box Mounting	Top		
Outline Drawing	B5A04T8310011B01	Connection Drawing	SC-01-T-1v-1a

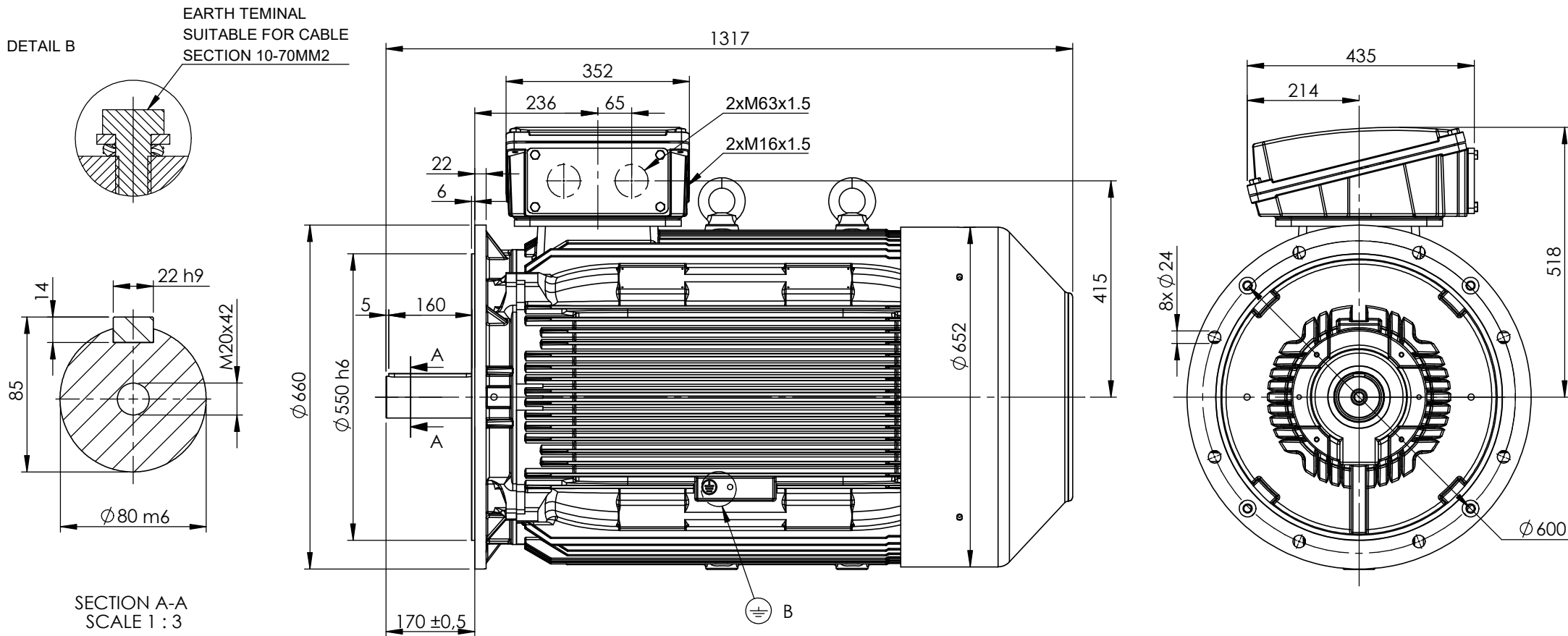

This is an uncontrolled document once printed or downloaded and is subject to change without notice. Date Created:12/02/2022



\oplus Earth terminal: 1 in the terminal box, 2 on the frame.

CUSTOMER REFERENCE AND ADDITIONAL INFORMATION:

MOTOR TYPE AND DESCRIPTION:

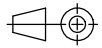
DRAWING REVISION 1	REVISION BY TN	DATE 18/05/2022	TOLERANCES (EXCEPT AS NOTED) TOLERANCES: \pm 2 * TOLERANCES: \pm 0.8	DRAWN BY TN	 
ECO	APPROVED BY LP	DATE 19/05/2022		DATE 01/12/2021	
ECO DESCRIPTION			DIMENSIONS ARE IN mm ACCORDING TO IEC 60072	APPROVED BY LP	DESCRIPTION Motor 315 4-6P TC (M/L) B5
<small>COPYRIGHT CEMP Srl. ALL RIGHTS RESERVED. PROPRIETARY AND CONFIDENTIAL INFORMATION - THIS DOCUMENT IS THE PROPERTY OF CEMP Srl. ("OWNER") AND CONTAINS OWNER'S PROPRIETARY INFORMATION. ANY PERSON, CORPORATION OR OTHER FIRM RECEIVING IT IS DEEMED, BY RECEIVING IT, TO AGREE THAT IT, AND/OR ANY PART OF IT, SHALL NOT BE DISCLOSED TO ANY PERSON, CORPORATION OR OTHER ENTITY, DUPLICATED, AND/OR USED, EXCEPT AS EXPRESSLY APPROVED IN WRITING IN ADVANCE BY OWNER. THIS DOCUMENT SHALL BE RETURNED TO OWNER UPON REQUEST. IT MAY BE SUBJECT TO CERTAIN RESTRICTIONS UNDER APPLICABLE EXPORT CONTROL LAWS AND REGULATIONS.</small>			SERIAL NUMBER	DATE 02/12/2021	
			FIRST ANGLE PROJECTION 		SIZE A4

Schema di collegamento - *Connection diagram*
Schemas de branchement - *Schaltplän*
Esquemas de conexión



DTE 01/01/2004
SC - 01 - T - 1v.doc

**Motori trifase una velocità - *Single speed, three phase motors* - Moteurs triphasé une vitesse
Drehstrommotor Eine Drehzahlstufe - Motores trifásico una velocidad**



L1 - L2 - L3 = Linea - *Supply* - Reseau - *Netz* - Red
Per invertire la rotazione invertire due fasi - *To change the rotation reverse two phases* - Pour changer le sens de rotation inverser deux phases - *Zur Drehrichtungsänderung zwei Phasen vertauschen* - Para invertir el sentido de rotación invertir dos fases

Marcatura Morsetti Ausiliari - <i>Additional terminals marking (IEC60034-8)</i>		
Marcatura <i>Marking</i>	No. morsetti <i>terminals</i>	Morsetto ausiliare per: <i>Additional terminal for:</i>
TP1A - TP2A (allarme- <i>warning</i>)	2	Termistori PTC (alta velocità) - <i>Thermistor PTC (high speed) [*]</i>
TP1B - TP2B (allarme- <i>warning</i>)	2	Termistori PTC (bassa velocità) - <i>Thermistor PTC (low speed) [*]</i>
R1 - R2 - R3 (I sensore - <i>sensor</i>)	3	
R4 - R5 - R6 (II sensore - <i>sensor</i>)	3	Termistore PT100 3 fili - <i>Thermistor PT 100 with 3 wires</i>
R7 - R8 - R9 (III sensore - <i>sensor</i>)	3	
R11 - R12 - R13 (anteriore - <i>DE</i>)	3	
R21 - R22 - R23 (posteriore - <i>NDE</i>)	3	Termistore PT100 su cuscinetto - <i>Thermistor PT 100 on bearing</i>
TB1 - TB2 (allarme- <i>warning</i>)	2	Protettore bimetallico normalmente chiuso -
TB3 - TB4 (intervento- <i>switch off</i>)	2	<i>Normally closed bi-metallic switch (**)</i>
TB8 - TB9 (intervento- <i>switch off</i>)	2	Protettore bimetallico del freno normalmente chiuso -
		<i>NC brake bi-metallic switch (**)</i>
TM1 - TM2 (allarme- <i>warning</i>)	2	Protettore bimetallico normalmente aperto -
TM3 - TM4 (intervento- <i>switch off</i>)	2	<i>Normally open bi-metallic switch (**)</i>
HE1- HE2	2	Resistenze riscaldanti - <i>Space heaters</i>
U1 - U2	2	Ventilazione ausiliaria monofase - <i>Single phase forced ventilation</i>
U - V - W	2	Ventilazione ausiliaria trifase - <i>Three phase forced ventilation</i>
colori secondo schema del produttore - <i>colours according manufacturer</i>	9	Encoder
CA1 - CA2	2	Condensatore - <i>Capacitor</i>
PE	1	Conduttore di terra - <i>Earth cable</i>

[*] U nominale - *U rated* = 6V - max 30V(**) U nominale - *U rated* = 250V

FOGLIO DATI PER MOTORI ELETTRICI ASINCRONI TRIFASI : SERIE IEC
DATA SHEET FOR ASYNCHRONOUS THREEPHASE INDUCTION MOTORS: IEC SERIES

Cliente / Customer	-
Ordine cliente / Customer order	-
Item	-

Conferma ordine / Acknowledgment	N° -
Impianto / Plant	-

DATI DI PROGETTO - DESIGN DATA

Modo di protezione		Motore / Frame
Type of protection		Scatola morsetti / Terminal box
Tem. Amb. Min. / Min Amb. Temp.	-20 °C	
Umidità relativa / Relative humidity	90%	
Tensione nominale / Rated Voltage	400 V +/- 10%	

	IP55
	IP55
Tem. Amb. Max. / Max Amb. Temp.	40 °C
Altitudine / Altitude	< 1000 mslm / masl
Frequenza / Frequency	50 Hz +/- 3%

DATI FUNZIONALI E COSTRUTTIVI - PERFORMANCE AND CONSTRUCTION DATA

1	Quantità / Quantity		01
2	Motore tipo / Motor type		TCI 315LC4
3	Numero di serie / Serial Number		
4	Forma costruttiva / Shape		B5
5			
6			
Dati nominali / Rated data			
7	Poli / Pole	n°	4
8	Potenza nominale / Rated power	kW	200,00
9	Corrente nominale / Rated current	A	344,86
10	Velocità nominale / Full Load speed	1/min	1489
11	Collegamento / Winding connection		D
12	Isolamento / Insulation class		F
13	Sovratemperatura / Temperature rise		DT80K
14	Raffreddamento / Cooling type		IC411
15	Fattore di servizio / Service factor		1
16			
17	Classe di rendimento / Efficiency level	IEC 34-30	IE3
Performances elettriche / Electrical performances			
	Carico / Load	4/4	3/4
18	Giri / Speed	1/min	1489
19	Corr. / Curr.	A	344,86
20	Rend / Eff	%	96,0
21	cos φ	-	0,87
Performances all'avviamento / Starting performances			
22	Ia/In - LRC/FLC	%	725
23	Cosphi a rotore bloccato / LR power factor		0,32
	Tempo a rotore bloccato / LRWT		
24	100% Un (A caldo / Warm)	sec	3
25	(A freddo / Cold)	sec	21
26	80% Un (A caldo / Warm)	sec	5
27	(A freddo / Cold)	sec	33
	Tempo di avviamento ammissibile / ART		
28	100% Un	sec	18
29	80% Un	sec	29
Curva di coppia / Speed-torque values			
30	Coppia nominale / Rated Torque	Nm	1282,74
31	Ca/Cn - LRT/FLT	%	220
32	Cmax/Cn - BDT/FLT	%	300
33			
34			
35			
Varie / Other			
36			
37			
38			
39			

Servizio / Duty			
40	Servizio / Duty type	-	S1
41	Intermittenza / Cyclic duration factor	-	-
42	Avviamenti-ora / Starting-hour	-	-
43	Tempo ciclo / Time		-
Cuscinetti / Bearings			
44	Cuscinetto ant / DE bearing	-	6319 C3
45	Cuscinetto post / NDE bearing	-	6319 C3
46	Carico radiale max / Max radial load in X1	N	5850
47	Carico assiale max / Max axial load	N	4000
48	Tipo grasso / Grease type		LGHP2 SKF or equivalent
49	Intervallo lubrificazione / Lubrication	h	3000
50	Quantità grasso / Quantity grease	gr	45
Caratteristiche meccaniche / mechanical specification			
51	Massa / Mass	kg	1223
52	Momento d'inerzia / Moment of inertia	kgm2	5,2344
53	Rumore a vuoto / Noise at no load (1 m)	Lp dB(A)	72
54	Vibrazioni / Vibration level	IEC 34-14	A
55	Limite norma / Vibration limit	mm/sec	2,80
56			
57			
58			
59			
60			
61			
62			
Dati entrata cavi - verniciatura / Cable entry and painting			
63	Entrata cavi / Cable entry	IEC 60423	2xM63+1xM16
64	Ciclo verniciatura / Painting cycle		STD
65	Colore finale / Final colour	RAL	5010
66			
67			
68			
69			
70			
71			
Ausiliari - Auxiliaries			
72	Sonde termiche / Temperature detector	winding	PTC
73	Sonde termiche / Temperature detector	bearing	-
74	Scaldiglie / Heaters	V / W	-
75	Preparation for SPM sensor		-
76	Pressacavi / Cable glands		NO
77			

Documento preliminare - Preliminary data sheet

**CURVA COPPIA/CORRENTE-GIRI
TORQUE/CURRENT-SPEED DIAGRAM**

Cliente / Customer -
 Ordine cliente / Customer order -
 Impianto / Plant -
ITEM -
 Conferma ordine / Acknowledgment -
 Numero di serie / Serial Number -

Motore / Motor **TCI 315LC4**
 Potenza nominale / Rated power 200,00 kW
 Poli / Pole 4
 Tensione - Frequenza / Voltage - Frequency 400 - 50 V - Hz
 Corrente / Rated current 344,84 A
 Velocità / Speed 1489 rpm
 Coppia / Torque 1282,65 Nm

— COPPIA - TORQUE — CORRENTE - CURRENT

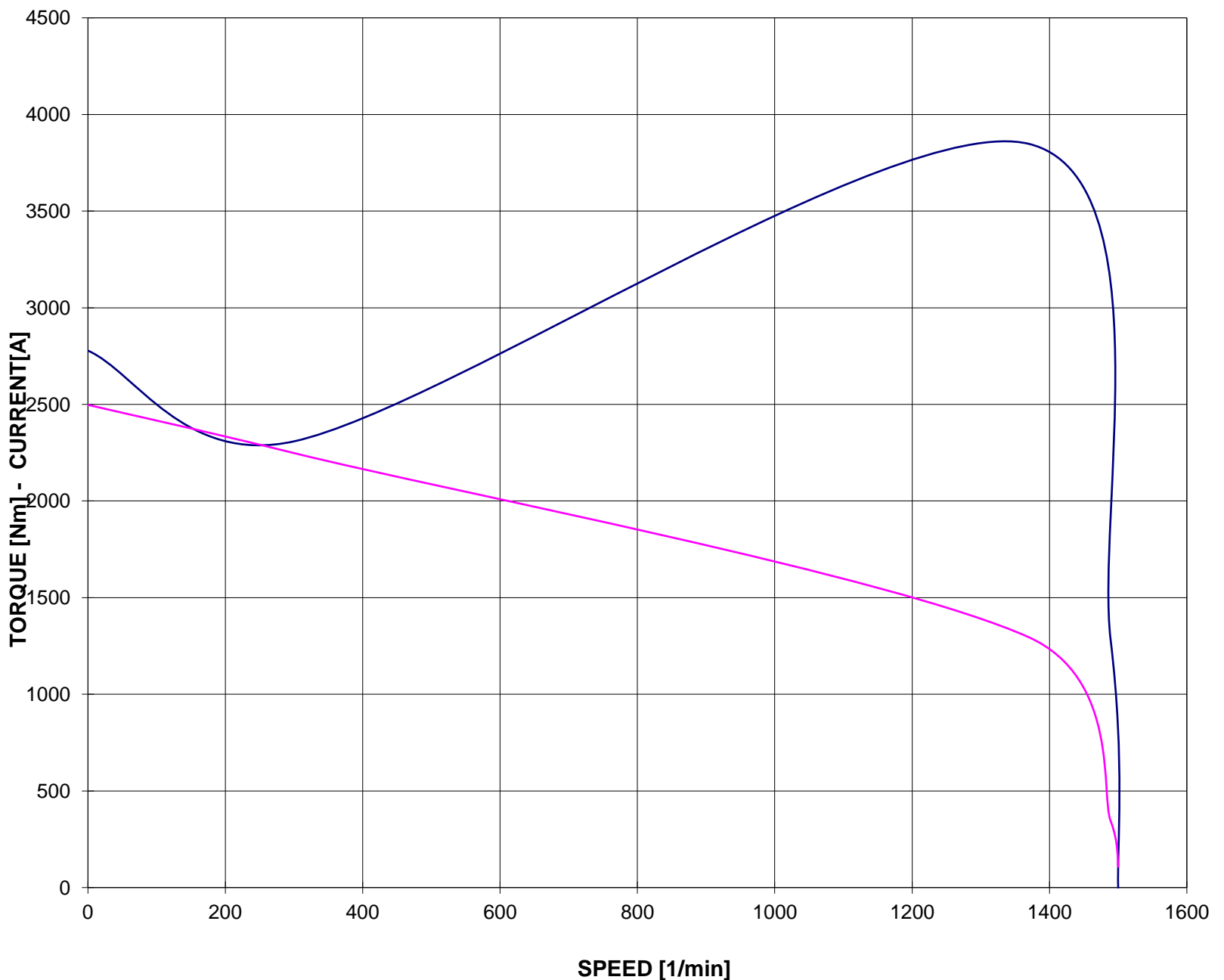

Valori calcolati - Data obtained by calculation method

CURVA COPPIA/CORRENTE-GIRI (Tensione ridotta)
TORQUE/CURRENT-SPEED DIAGRAM (Reduced voltage)

Cliente / Customer -
Ordine cliente / Customer order -
Impianto / Plant -
ITEM -
Conferma ordine / Acknowledgment -
Numero di serie / Serial Number -

Motore / Motor **TCI 315LC4**
Potenza nominale / Rated power 200,00 kW
Poli / Pole 4
Tensione - Frequenza / Voltage - Frequency 400 - 50 V - Hz
Corrente / Rated current 344,84 A
Velocità / Speed 1489 rpm
Coppia / Torque 1282,65 Nm

— COPPIA - TORQUE — CORRENTE - CURRENT
- - - COPPIA - TORQUE 80% Un - - - CORRENTE - CURRENT 80% Un

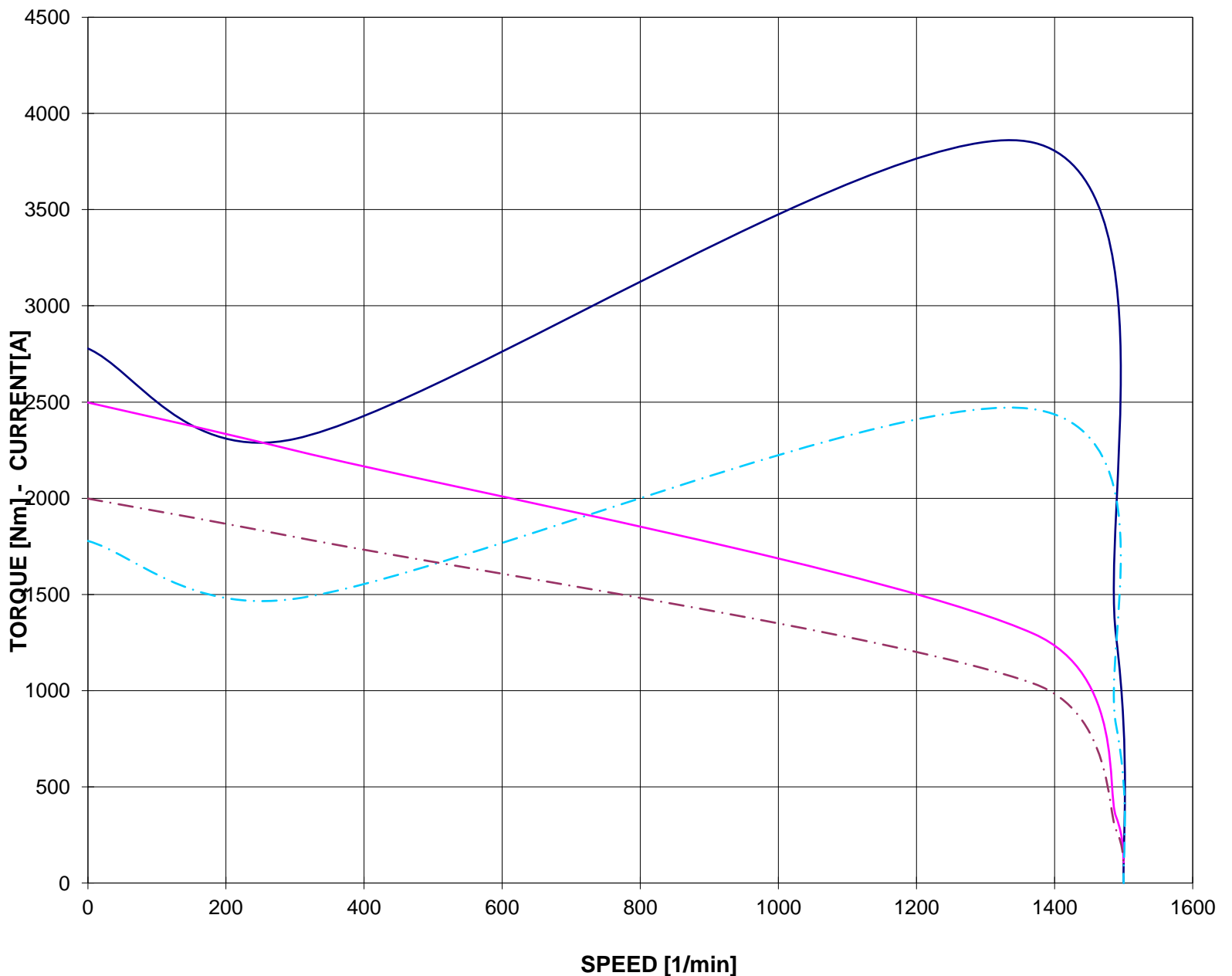

Valori calcolati - Data obtained by calculation method

**CURVE CARATTERISTICHE
PERFORMANCE CURVES**

Cliente / Customer -
Ordine cliente / Customer order -
Impianto / Plant -
ITEM -

Conferma ordine / Acknowledgment -
Numero di serie / Serial Number -

Motore / Motor	TCI 315LC4	
Potenza nominale / Rated power	200,00	kW
Poli / Pole	4	
Tensione - Frequenza / Voltage - Frequency	400 - 50	V - Hz
Corrente / Rated current	344,84	A
Velocità / Speed	1489	rpm
Coppia / Torque	1282,65	Nm

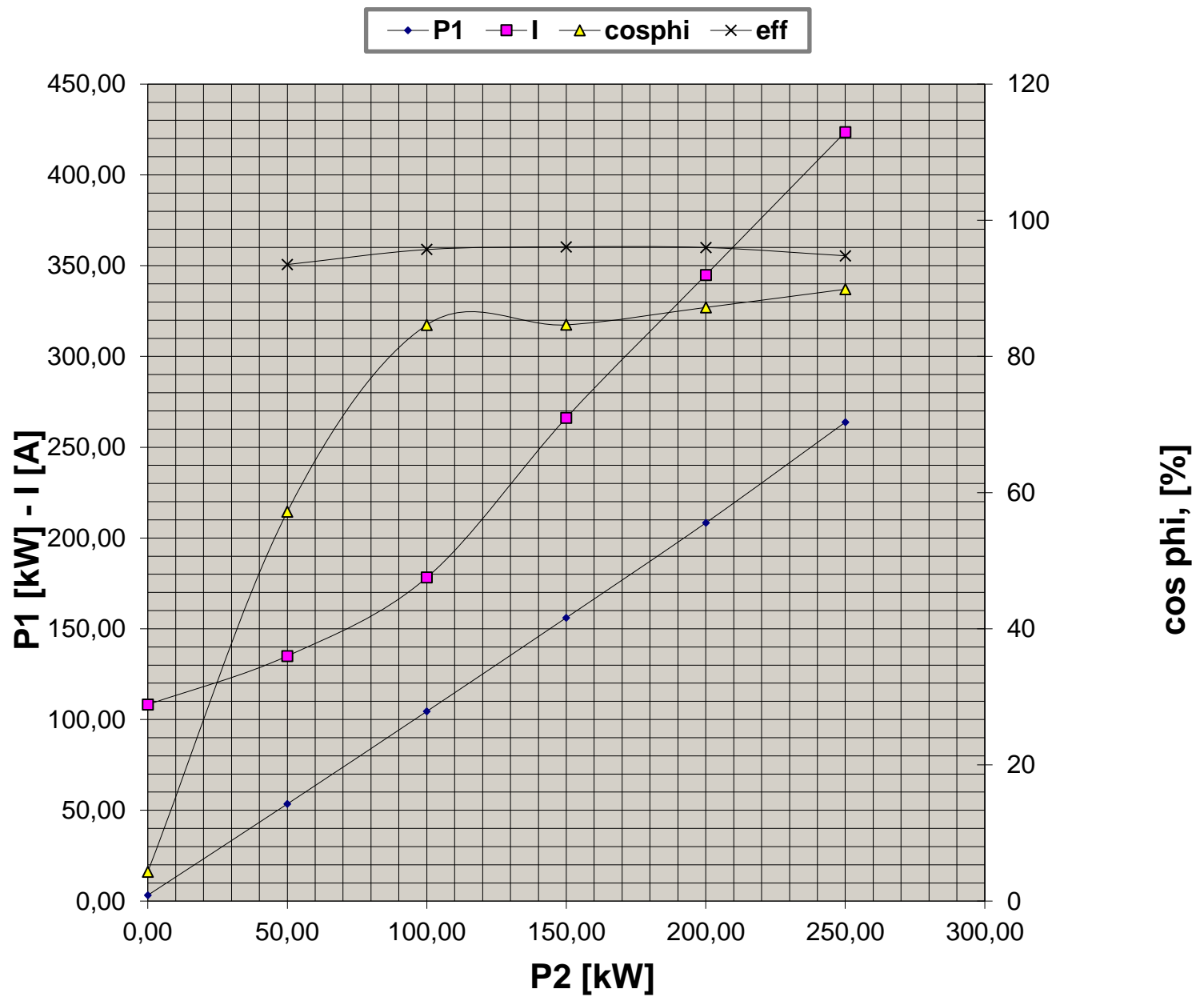

Valori calcolati - Data obtained by calculation method

**CURVA LIMITE CORRENTE TEMPO
THERMAL WITHSTAND CURVE**

Cliente / Customer -
 Ordine cliente / Customer order -
 Impianto / Plant -
ITEM -
 Conferma ordine / Acknowledgment -
 Numero di serie / Serial Number -

Motore / Motor	TCI 315LC4	
Potenza nominale / Rated power	200,00	kW
Poli / Pole	4	
Tensione - Frequenza / Voltage - Frequency	400 - 50	V - Hz
Corrente / Rated current	344,84	A
Velocità / Speed	1489	rpm
Coppia / Torque	1282,65	Nm

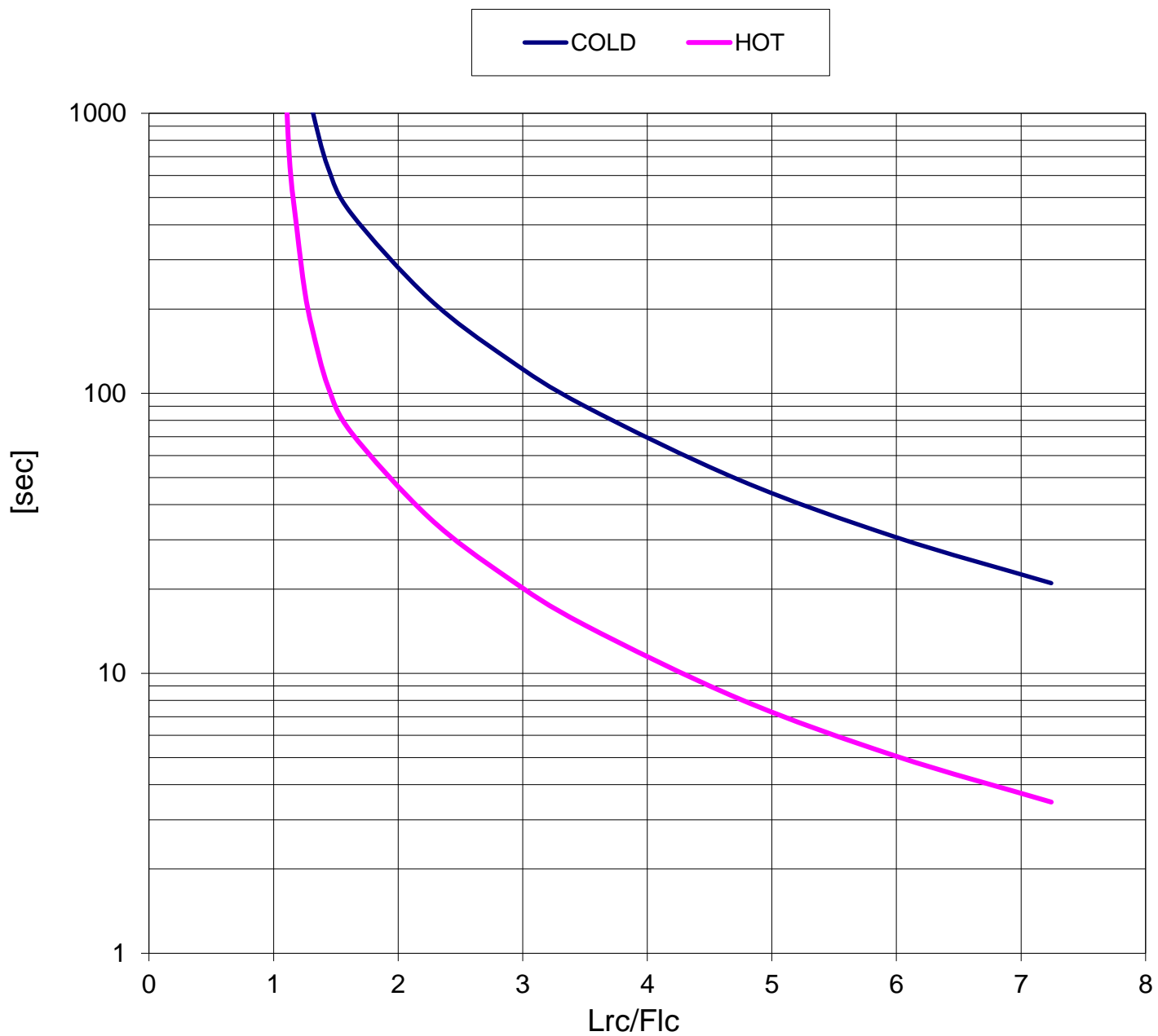

Valori calcolati - Data obtained by calculation method

CURVA LIMITE CORRENTE TEMPO (Tensione ridotta)
THERMAL WITHSTAND CURVE (Reduced voltage)

Cliente / Customer -
 Ordine cliente / Customer order -
 Impianto / Plant -
ITEM -
 Conferma ordine / Acknowledgment -
 Numero di serie / Serial Number -

Motore / Motor	TCI 315LC4	
Potenza nominale / Rated power	200,00	kW
Poli / Pole	4	
Tensione - Frequenza / Voltage - Frequency	400 - 50	V - Hz
Corrente / Rated current	344,84	A
Velocità / Speed	1489	rpm
Coppia / Torque	1282,65	Nm

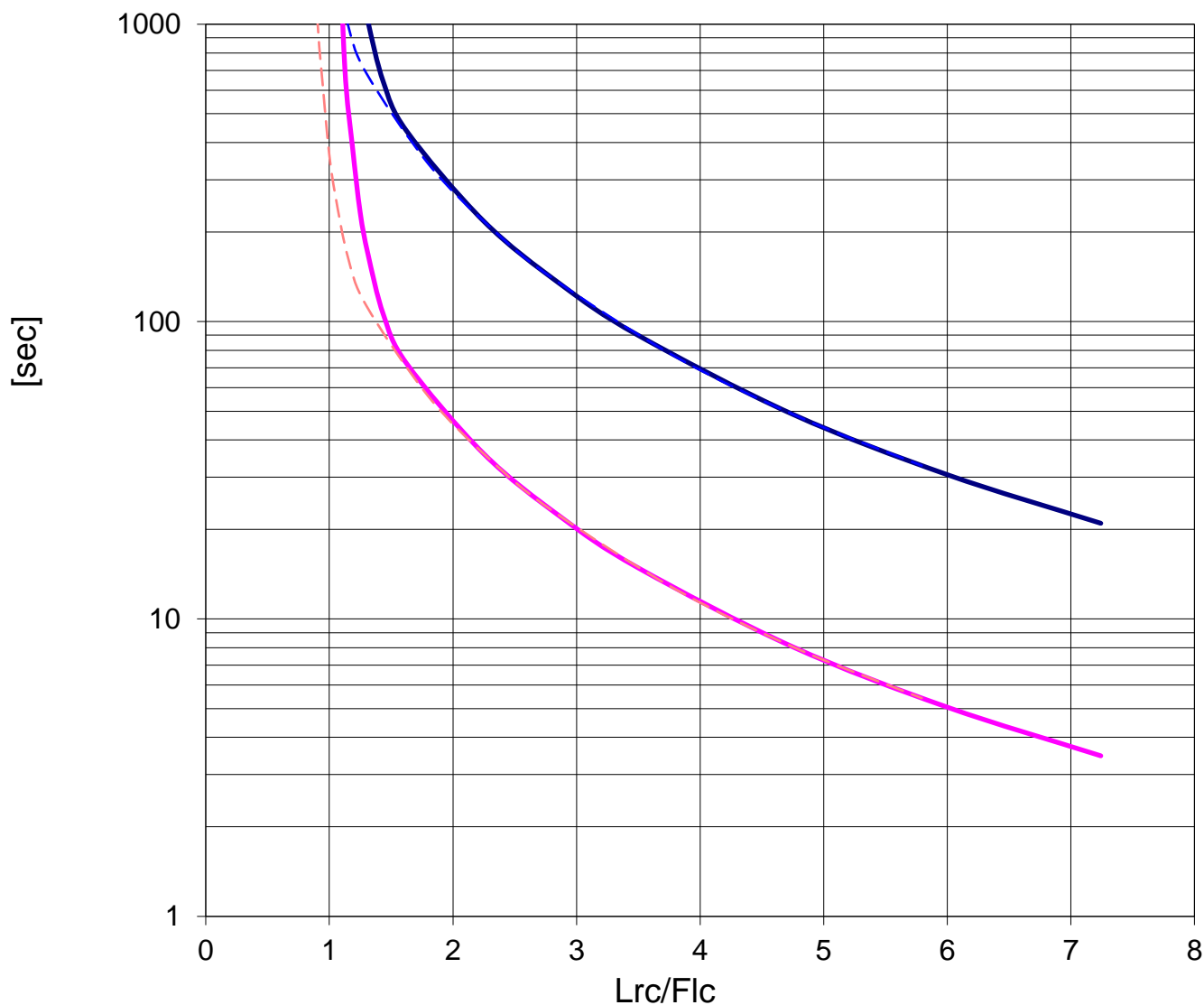
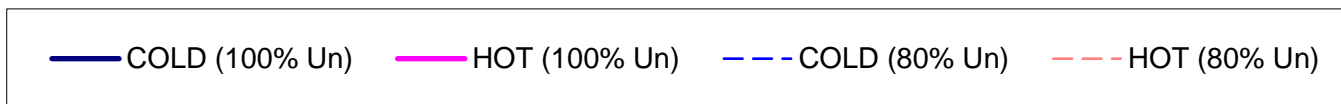

Valori calcolati - Data obtained by calculation method