

PRODUCT INFORMATION PACKET

Model No: E3TI3002255B50D41100

Catalog No: E3TI3002255B50D41100

Made in Italy TCI Series, General Purpose Low Voltage IEC motor, Safe Area, 55,00 kW, 3 phase,
2981 RPM, D400/Y690V 50Hz, 250M Frame B5, 2 Poles, IC411



Regal and CEMP are trademarks of Regal Rexnord Corporation or one of its affiliated companies.

©2022 Regal Rexnord Corporation, All Rights Reserved. MC017097E

Nameplate Specifications

Output HP	75 Hp	Output KW	55.0 kW
Frequency	50 Hz	Voltage	400/690 V
Current	93.3 A	Speed	2981 rpm
Service Factor	1	Phase	3
Efficiency	94.3 %	Power Factor	0.9
Duty	S1	Insulation Class	F
Frame	250M	Enclosure	Totally Enclosed Fan Cooled
Thermal Protection	No Protection	Ambient Temperature	40 °C
Drive End Bearing Size	6314	Opp Drive End Bearing Size	6314
UL	No	CSA	No
CE	Yes	IP Code	IP55
Number of Speeds	1		

Technical Specifications

Electrical Type	Squirrel Cage	Starting Method	Direct On Line
Poles	2	Rotation	Bi-Directional
Mounting	B5	Motor Orientation	Horizontal
Drive End Bearing	C3	Opp Drive End Bearing	C3
Frame Material	Cast Iron	Shaft Type	Keyed
Overall Length	941.00 mm	Frame Length	460.00 mm
Shaft Diameter	60.000 mm	Shaft Extension	140 mm
Assembly/Box Mounting	Top		
Connection Drawing	SC-01-T-1v-1a	Outline Drawing	B5A04T8250001B01

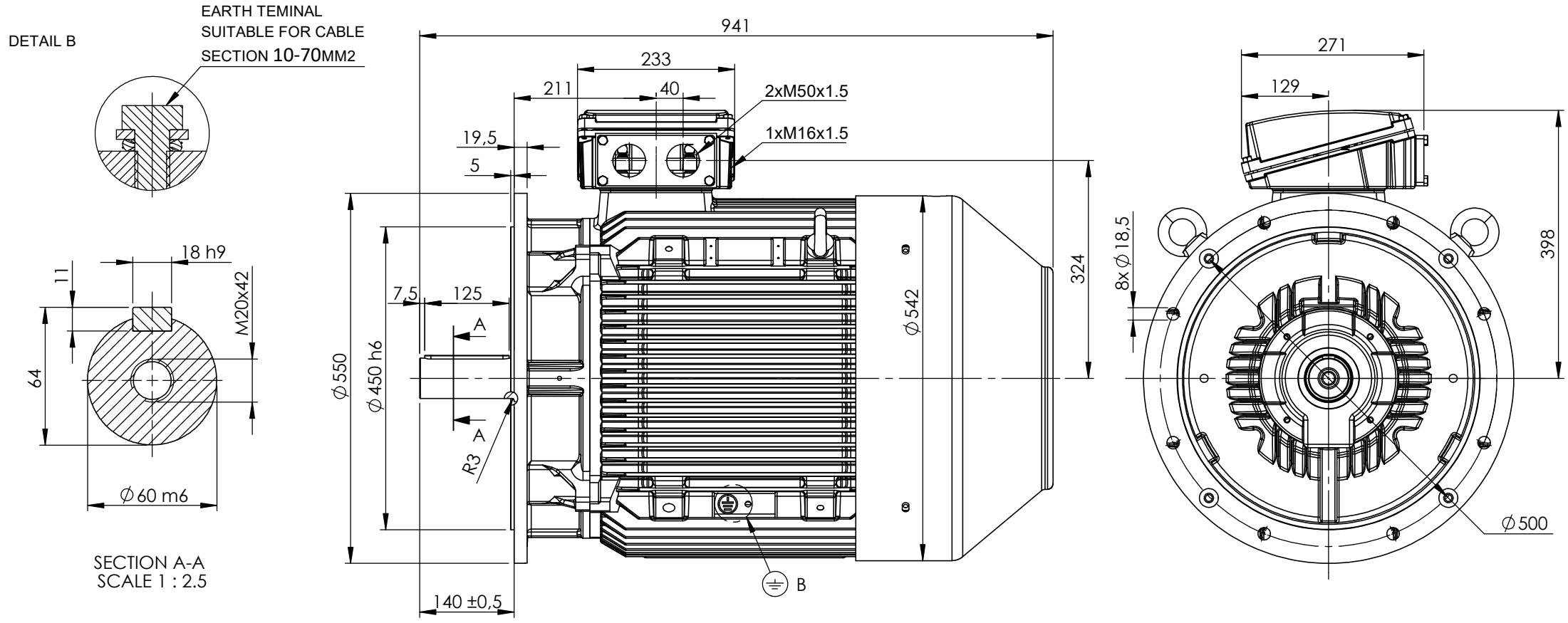

This is an uncontrolled document once printed or downloaded and is subject to change without notice. Date Created:12/02/2022



 Earth terminal: 1 in the terminal box, 2 on the frame.

CUSTOMER REFERENCE AND ADDITIONAL INFORMATION:

MOTOR TYPE AND DESCRIPTION:

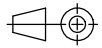
DRAWING REVISION		REVISION BY		DATE		TOLERANCES (EXCEPT AS NOTED)		DRAWN BY		 	
1		TN		09/05/2022		TOLERANCES: ±2 * TOLERANCES: ±0.8		TN			
ECO		APPROVED BY		DATE		DIMENSIONS ARE IN mm ACCORDING TO IEC 60072		DATE		DESCRIPTION	
		LP		10/05/2022				23/11/2021			
ECO DESCRIPTION						SERIAL NUMBER		APPROVED BY		Motor 250 2P TC (L) B5	
COPYRIGHT CEMP Srl. ALL RIGHTS RESERVED. PROPRIETARY AND CONFIDENTIAL INFORMATION - THIS DOCUMENT IS THE PROPERTY OF CEMP Srl. ("OWNER") AND CONTAINS OWNER'S PROPRIETARY INFORMATION. ANY PERSON, CORPORATION OR OTHER FIRM RECEIVING IT IS DEEMED, BY RECEIVING IT, TO AGREE THAT IT, AND/OR ANY PART OF IT, SHALL NOT BE DISCLOSED TO ANY PERSON, CORPORATION OR OTHER ENTITY, DUPLICATED, AND/OR USED, EXCEPT AS EXPRESSLY APPROVED IN WRITING IN ADVANCE BY OWNER. THIS DOCUMENT SHALL BE RETURNED TO OWNER UPON REQUEST. IT MAY BE SUBJECT TO CERTAIN RESTRICTIONS UNDER APPLICABLE EXPORT CONTROL LAWS AND REGULATIONS.								LP			
24/11/2021											
								REFERENCE		SHEET	
								FIRST ANGLE PROJECTION			
										B5A04T8250001B01 3 of 11	
								A4		1 OF 2	

Schema di collegamento - *Connection diagram*
Schemas de branchement - *Schaltplän*
Esquemas de conexión



DTE 01/01/2004
SC - 01 - T - 1v.doc

**Motori trifase una velocità - *Single speed, three phase motors* - Moteurs triphasé une vitesse
Drehstrommotor Eine Drehzahlstufe - Motores trifásico una velocidad**



L1 - L2 - L3 = Linea - *Supply* - Reseau - *Netz* - Red
Per invertire la rotazione invertire due fasi - *To change the rotation reverse two phases* - Pour changer le sens de rotation inverser deux phases - *Zur Drehrichtungsänderung zwei Phasen vertauschen* - Para invertir el sentido de rotación invertir dos fases

Marcatura Morsetti Ausiliari - <i>Additional terminals marking (IEC60034-8)</i>		
Marcatura <i>Marking</i>	No. morsetti <i>terminals</i>	Morsetto ausiliare per: <i>Additional terminal for:</i>
TP1A - TP2A (allarme- <i>warning</i>)	2	Termistori PTC (alta velocità) - <i>Thermistor PTC (high speed) [*]</i>
TP1B - TP2B (allarme- <i>warning</i>)	2	Termistori PTC (bassa velocità) - <i>Thermistor PTC (low speed) [*]</i>
R1 - R2 - R3 (I sensore - <i>sensor</i>)	3	
R4 - R5 - R6 (II sensore - <i>sensor</i>)	3	Termistore PT100 3 fili - <i>Thermistor PT 100 with 3 wires</i>
R7 - R8 - R9 (III sensore - <i>sensor</i>)	3	
R11 - R12 - R13 (anteriore - <i>DE</i>)	3	
R21 - R22 - R23 (posteriore - <i>NDE</i>)	3	Termistore PT100 su cuscinetto - <i>Thermistor PT 100 on bearing</i>
TB1 - TB2 (allarme- <i>warning</i>)	2	Protettore bimetallico normalmente chiuso -
TB3 - TB4 (intervento- <i>switch off</i>)	2	<i>Normally closed bi-metallic switch (**)</i>
TB8 - TB9 (intervento- <i>switch off</i>)	2	Protettore bimetallico del freno normalmente chiuso -
		<i>NC brake bi-metallic switch (**)</i>
TM1 - TM2 (allarme- <i>warning</i>)	2	Protettore bimetallico normalmente aperto -
TM3 - TM4 (intervento- <i>switch off</i>)	2	<i>Normally open bi-metallic switch (**)</i>
HE1- HE2	2	Resistenze riscaldanti - <i>Space heaters</i>
U1 - U2	2	Ventilazione ausiliaria monofase - <i>Single phase forced ventilation</i>
U - V - W	2	Ventilazione ausiliaria trifase - <i>Three phase forced ventilation</i>
colori secondo schema del produttore - <i>colours according manufacturer</i>	9	Encoder
CA1 - CA2	2	Condensatore - <i>Capacitor</i>
PE	1	Conduttore di terra - <i>Earth cable</i>

[*] U nominale - *U rated* = 6V - max 30V(**) U nominale - *U rated* = 250V

FOGLIO DATI PER MOTORI ELETTRICI ASINCRONI TRIFASI : SERIE IEC
DATA SHEET FOR ASYNCHRONOUS THREEPHASE INDUCTION MOTORS: IEC SERIES

Cliente / Customer	-
Ordine cliente / Customer order	-
Item	-

Conferma ordine / Acknowledgment	N° -
Impianto / Plant	-

DATI DI PROGETTO - DESIGN DATA

Modo di protezione		Motore / Frame
Type of protection		Scatola morsetti / Terminal box
Tem. Amb. Min. / Min Amb. Temp.	-20 °C	
Umidità relativa / Relative humidity	90%	
Tensione nominale / Rated Voltage	400 V +/- 10%	

	IP55
	IP55
Tem. Amb. Max. / Max Amb. Temp.	40 °C
Altitudine / Altitude	< 1000 mslm / masl
Frequenza / Frequency	50 Hz +/- 3%

DATI FUNZIONALI E COSTRUTTIVI - PERFORMANCE AND CONSTRUCTION DATA

1	Quantità / Quantity		01
2	Motore tipo / Motor type		TCI 250M2
3	Numero di serie / Serial Number		
4	Forma costruttiva / Shape		B5
5			
6			
Dati nominali / Rated data			
7	Poli / Pole	n°	2
8	Potenza nominale / Rated power	kW	55,00
9	Corrente nominale / Rated current	A	93,34
10	Velocità nominale / Full Load speed	1/min	2981
11	Collegamento / Winding connection		D
12	Isolamento / Insulation class		F
13	Sovratemperatura / Temperature rise		DT80K
14	Raffreddamento / Cooling type		IC411
15	Fattore di servizio / Service factor		1
16			
17	Classe di rendimento / Efficiency level	IEC 34-30	IE3
Performances elettriche / Electrical performances			
	Carico / Load	4/4	3/4
		2/4	
18	Giri / Speed	1/min	2981
			2987
			2992
19	Corr. / Curr.	A	93,34
			72,78
			54,00
20	Rend / Eff	%	94,3
			94,3
			93,7
21	cos φ	-	0,90
			0,87
			0,79
Performances all'avviamento / Starting performances			
22	Ia/In - LRC/FLC	%	750
23	Cosphi a rotore bloccato / LR power factor		0,37
	Tempo a rotore bloccato / LRWT		
24	100% Un (A caldo / Warm)	sec	6
25	(A freddo / Cold)	sec	29
26	80% Un (A caldo / Warm)	sec	10
27	(A freddo / Cold)	sec	45
	Tempo di avviamento ammissibile / ART		
28	100% Un	sec	25
29	80% Un	sec	40
Curva di coppia / Speed-torque values			
30	Coppia nominale / Rated Torque	Nm	176,20
31	Ca/Cn - LRT/FLT	%	180
32	Cmax/Cn - BDT/FLT	%	320
33			
34			
35			
Varie / Other			
36			
37			
38			
39			

Servizio / Duty			
40	Servizio / Duty type	-	S1
41	Intermittenza / Cyclic duration factor	-	-
42	Avviamenti-ora / Starting-hour	-	-
43	Tempo ciclo / Time		-
Cuscinetti / Bearings			
44	Cuscinetto ant / DE bearing	-	6314 C3
45	Cuscinetto post / NDE bearing	-	6314 C3
46	Carico radiale max / Max radial load in X1	N	4869
47	Carico assiale max / Max axial load	N	3434
48	Tipo grasso / Grease type		LGHP2 SKF or equivalent
49	Intervallo lubrificazione / Lubrication	h	1500
50	Quantità grasso / Quantity grease	gr	26
Caratteristiche meccaniche / mechanical specification			
51	Massa / Mass	kg	492
52	Momento d'inerzia / Moment of inertia	kgm2	0,6618
53	Rumore a vuoto / Noise at no load (1 m)	Lp dB(A)	77
54	Vibrazioni / Vibration level	IEC 34-14	A
55	Limite norma / Vibration limit	mm/sec	2,20
56			
57			
58			
59			
60			
61			
62			
Dati entrata cavi - verniciatura / Cable entry and painting			
63	Entrata cavi / Cable entry	IEC 60423	2xM50+1xM16
64	Ciclo verniciatura / Painting cycle		STD
65	Colore finale / Final colour	RAL	5010
66			
67			
68			
69			
70			
71			
Ausiliari - Auxiliaries			
72	Sonde termiche / Temperature detector	winding	PTC
73	Sonde termiche / Temperature detector	bearing	-
74	Scaldiglie / Heaters	V / W	-
75	Preparation for SPM sensor		-
76	Pressacavi / Cable glands		NO
77			

Documento preliminare - Preliminary data sheet

**CURVA COPPIA/CORRENTE-GIRI
TORQUE/CURRENT-SPEED DIAGRAM**

Cliente / Customer -
 Ordine cliente / Customer order -
 Impianto / Plant -
ITEM -
 Conferma ordine / Acknowledgment -
 Numero di serie / Serial Number -

Motore / Motor **TCI 250M2**
 Potenza nominale / Rated power 55,00 kW
 Poli / Pole 2
 Tensione - Frequenza / Voltage - Frequency 400 - 50 V - Hz
 Corrente / Rated current 93,34 A
 Velocità / Speed 2981 rpm
 Coppia / Torque 176,20 Nm

— COPPIA - TORQUE — CORRENTE - CURRENT

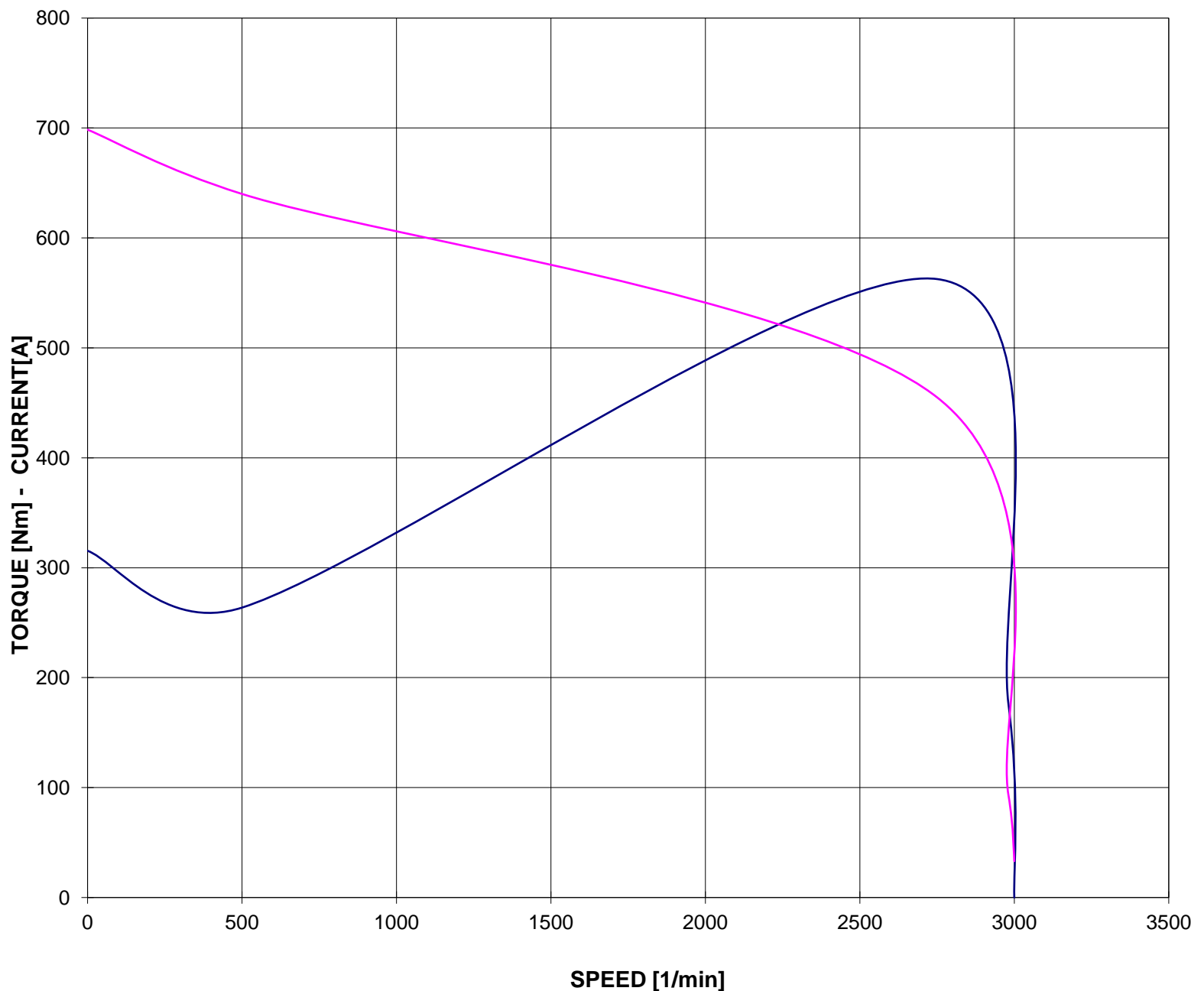

Valori calcolati - Data obtained by calculation method
 Documento preliminare - Preliminary document

Data / Date 24-feb-22

CURVA COPPIA/CORRENTE-GIRI (Tensione ridotta)
TORQUE/CURRENT-SPEED DIAGRAM (Reduced voltage)

Cliente / Customer -
Ordine cliente / Customer order -
Impianto / Plant -
ITEM -
Conferma ordine / Acknowledgment -
Numero di serie / Serial Number -

Motore / Motor **TCI 250M2**
Potenza nominale / Rated power 55,00 kW
Poli / Pole 2
Tensione - Frequenza / Voltage - Frequency 400 - 50 V - Hz
Corrente / Rated current 93,34 A
Velocità / Speed 2981 rpm
Coppia / Torque 176,20 Nm

— COPPIA - TORQUE — CORRENTE - CURRENT
- - - COPPIA - TORQUE 80% Un - - - CORRENTE - CURRENT 80% Un

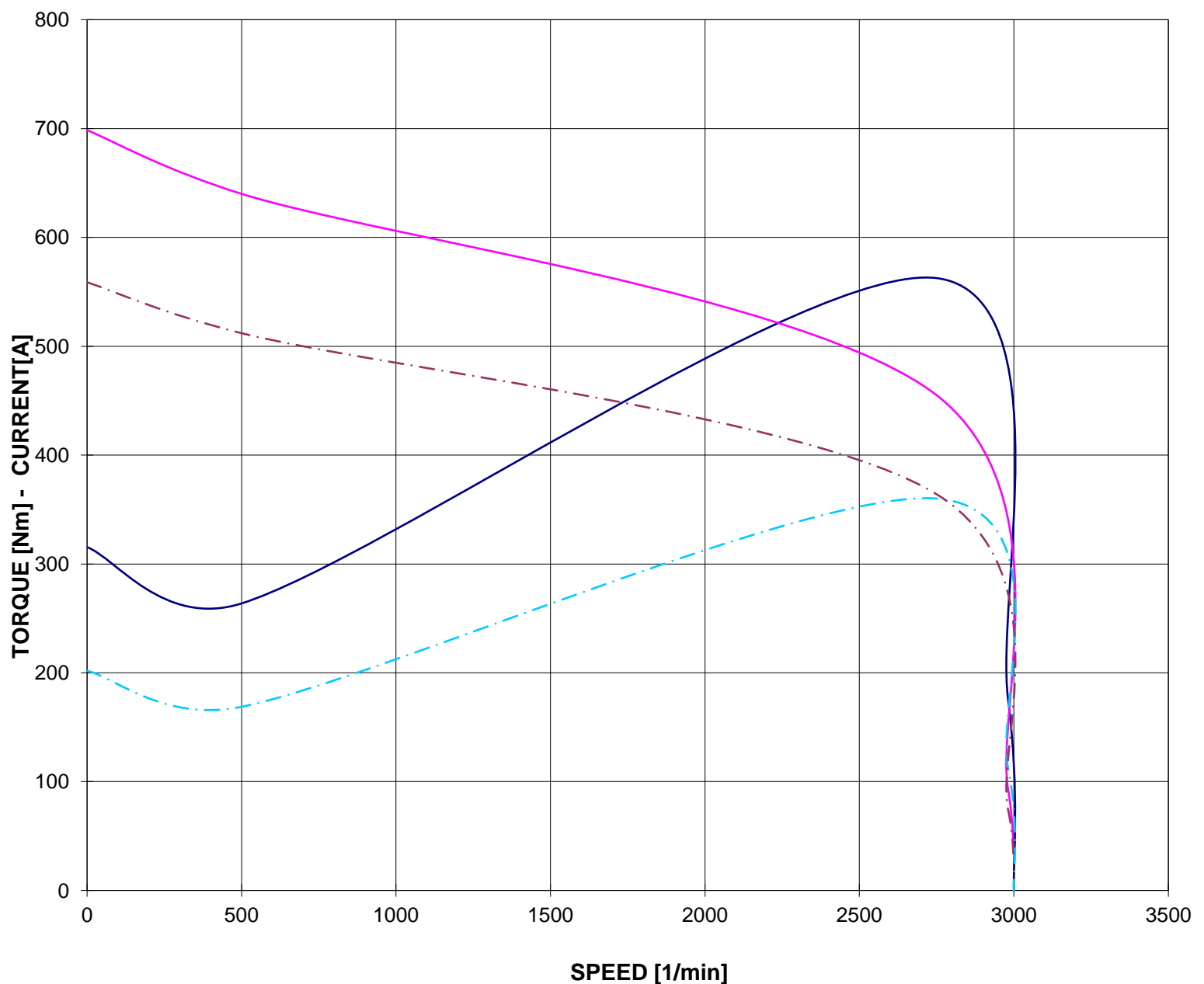

Valori calcolati - Data obtained by calculation method
Documento preliminare - Preliminary document

Data / Date 24-feb-22

**CURVE CARATTERISTICHE
PERFORMANCE CURVES**

Cliente / Customer -
 Ordine cliente / Customer order -
 Impianto / Plant -
ITEM -
 Conferma ordine / Acknowledgment -
 Numero di serie / Serial Number -

Motore / Motor **TCI 250M2**
 Potenza nominale / Rated power 55,00 kW
 Poli / Pole 2
 Tensione - Frequenza / Voltage - Frequency 400 - 50 V - Hz
 Corrente / Rated current 93,34 A
 Velocità / Speed 2981 rpm
 Coppia / Torque 176,20 Nm

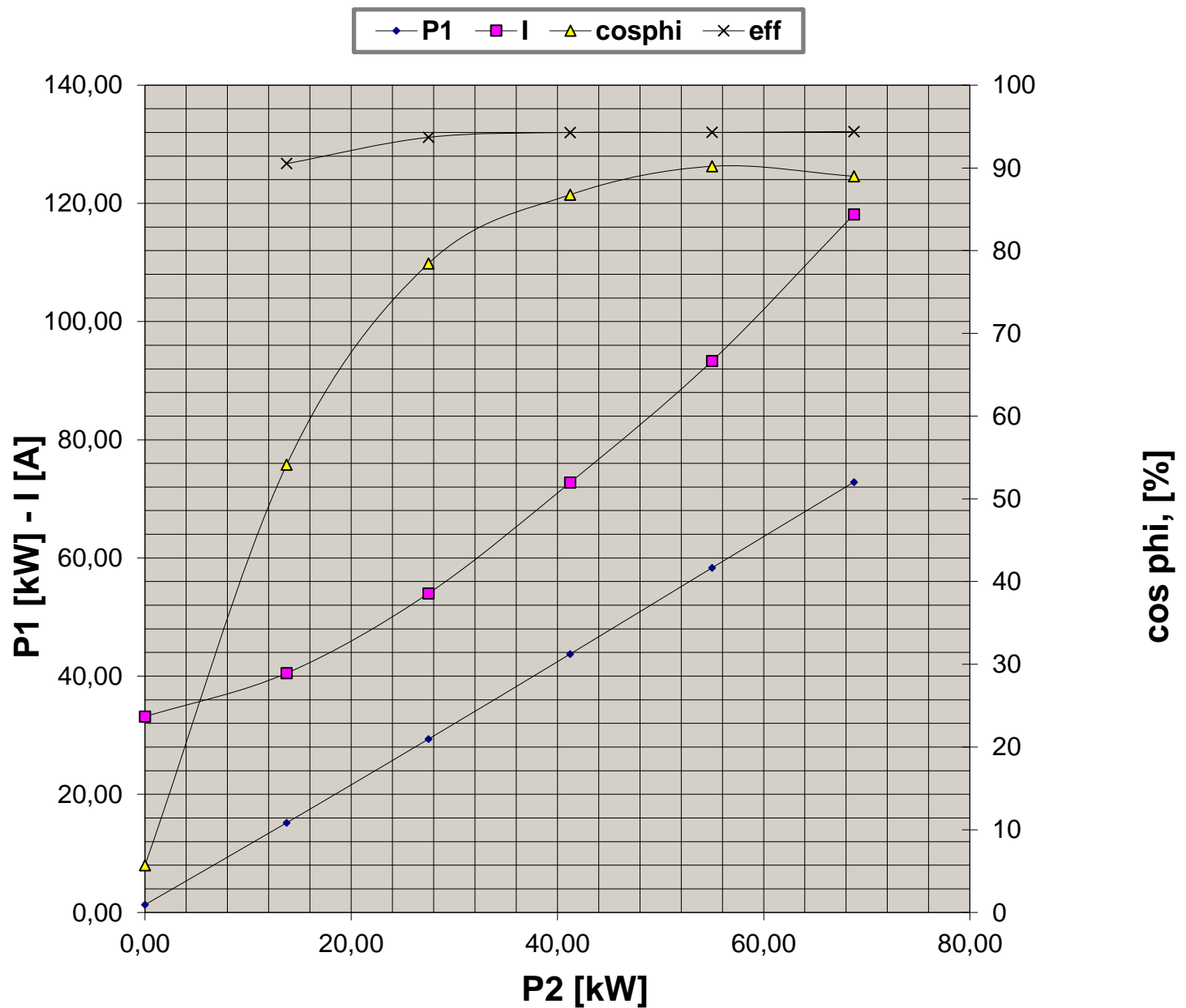

Valori calcolati - Data obtained by calculation method
 Documento preliminare - Preliminary document

Data / Date 24-feb-22

**CURVA LIMITE CORRENTE TEMPO
THERMAL WITHSTAND CURVE**

Cliente / Customer -
 Ordine cliente / Customer order -
 Impianto / Plant -
ITEM -
 Conferma ordine / Acknowledgment -
 Numero di serie / Serial Number -

Motore / Motor **TCI 250M2**
 Potenza nominale / Rated power 55,00 kW
 Poli / Pole 2
 Tensione - Frequenza / Voltage - Frequency 400 - 50 V - Hz
 Corrente / Rated current 93,34 A
 Velocità / Speed 2981 rpm
 Coppia / Torque 176,20 Nm

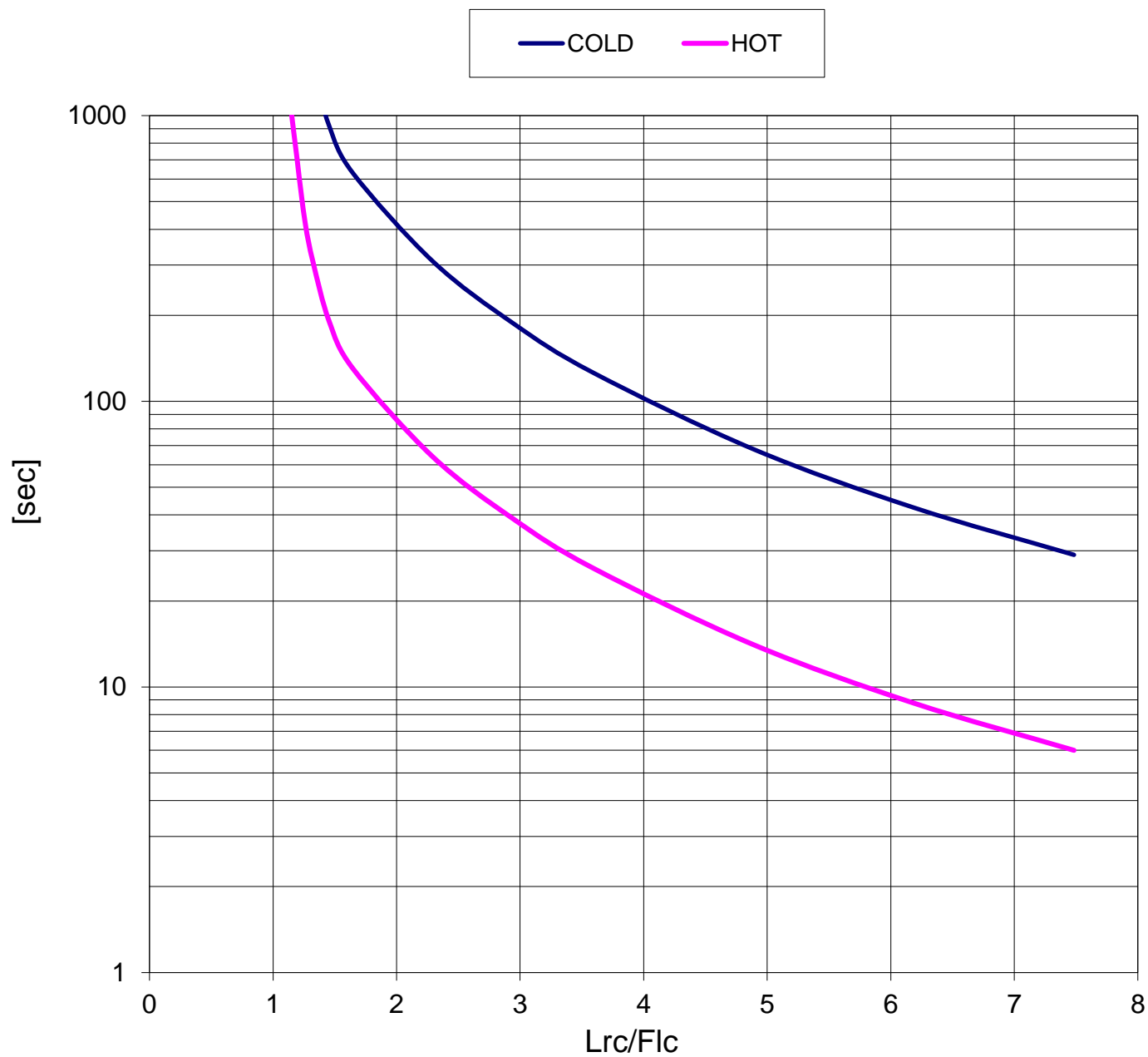

Valori calcolati - Data obtained by calculation method
 Documento preliminare - Preliminary document

Data / Date 24-feb-22

CURVA LIMITE CORRENTE TEMPO (Tensione ridotta)
THERMAL WITHSTAND CURVE (Reduced voltage)

Cliente / Customer -
 Ordine cliente / Customer order -
 Impianto / Plant -
ITEM -
 Conferma ordine / Acknowledgment -
 Numero di serie / Serial Number -

Motore / Motor	TCI 250M2	
Potenza nominale / Rated power	55,00	kW
Poli / Pole	2	
Tensione - Frequenza / Voltage - Frequency	400 - 50	V - Hz
Corrente / Rated current	93,34	A
Velocità / Speed	2981	rpm
Coppia / Torque	176,20	Nm

— COLD (100% Un) — HOT (100% Un) - - - COLD (80% Un) - - - HOT (80% Un)

