

PRODUCT INFORMATION PACKET

Model No: E3AC3004287B35D41100

Catalog No: E3AC3004287B35D41100

Made in Italy E3AC30 Series, General Purpose Low Voltage IEC motor IE3, Flameproof, 110,00kW,
3 phase, 1489 RPM, D400/Y690V 50Hz, 280MB Frame B35, 4 Poles, IC411, Higher Output Motor



Regal and CEMP are trademarks of Regal Rexnord Corporation or one of its affiliated companies.

©2023 Regal Rexnord Corporation, All Rights Reserved. MC017097E

Nameplate Specifications

Phase	3	Output HP	150.0 Hp
Output KW	110.0 kW	Voltage	400/690 V
Speed	1489 rpm	Service Factor	1
Frame	280MB	Enclosure	Totally Enclosed Fan Cooled
Efficiency	95.5 %	Ambient Temperature	40 °C
Frequency	50 Hz	Power Factor	0.86
Duty	S1	Insulation Class	F
Drive End Bearing Size	6316	Opp Drive End Bearing Size	6316
UL	No	CSA	No
CE	Yes	IP Code	IP55
Number of Speeds	1		

Technical Specifications

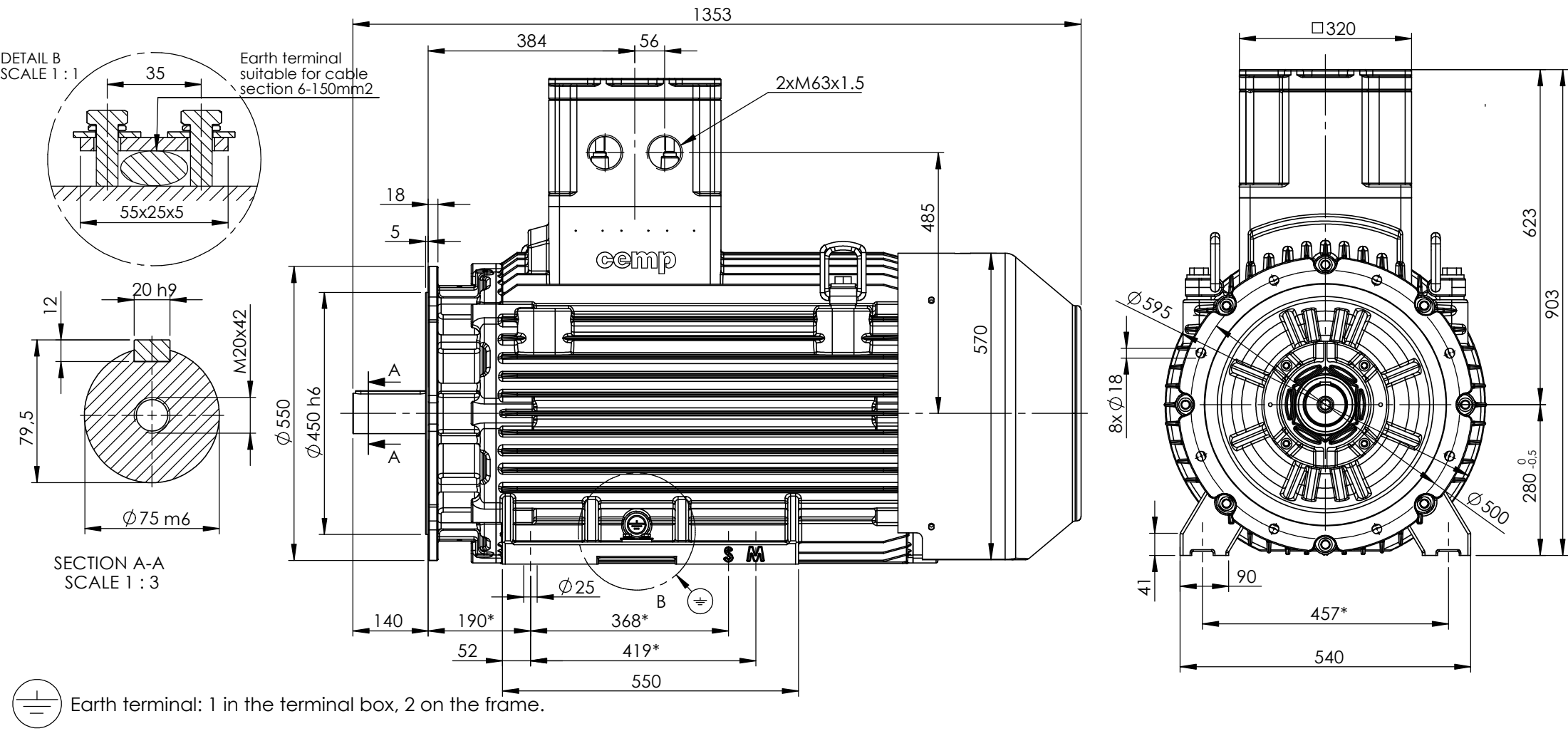

Electrical Type	Squirrel Cage	Starting Method	Direct On Line
Poles	4	Rotation	Bi-Directional
Mounting	B35	Motor Orientation	Horizontal
Drive End Bearing	Zz C3	Opp Drive End Bearing	Zz C3
Frame Material	Cast Iron	Shaft Type	Keyed
Overall Length	1489.00 mm	Frame Length	775.00 mm
Shaft Diameter	75.000 mm	Shaft Extension	140 mm
Assembly/Box Mounting	Top		
Outline Drawing	B3A04E8280011D01	Connection Drawing	SC-01-T-1v-1a

This is an uncontrolled document once printed or downloaded and is subject to change without notice. Date Created:10/10/2023



CUSTOMER REFERENCE AND ADDITIONAL INFORMATION:

MOTOR TYPE AND DESCRIPTION:

DRAWING REVISION	REVISION BY	DATE	TOLERANCES (EXCEPT AS NOTED) TOLERANCES: ±2 * TOLERANCES: ±0.8	DRAWN BY	DP	 		
ECO	APPROVED BY	DATE		DIMENSIONS ARE IN mm ACCORDING TO IEC 60072	DATE		15/02/2017	
ECO DESCRIPTION			SERIAL NUMBER	APPROVED BY	DP	DESCRIPTION Motor A280 MA/MB (L) 4-6-8P B35 IE3		
COPYRIGHT CEMP Srl. ALL RIGHTS RESERVED. PROPRIETARY AND CONFIDENTIAL INFORMATION - THIS DOCUMENT IS THE PROPERTY OF CEMP Srl. ("OWNER") AND CONTAINS OWNER'S PROPRIETARY INFORMATION. ANY PERSON, CORPORATION OR OTHER FIRM RECEIVING IT IS DEEMED, BY RECEIVING IT, TO AGREE THAT IT, AND/OR ANY PART OF IT, SHALL NOT BE DISCLOSED TO ANY PERSON, CORPORATION OR OTHER ENTITY, DUPLICATED, AND/OR USED, EXCEPT AS EXPRESSLY APPROVED IN WRITING IN ADVANCE BY OWNER. THIS DOCUMENT SHALL BE RETURNED TO OWNER UPON REQUEST. IT MAY BE SUBJECT TO CERTAIN RESTRICTIONS UNDER APPLICABLE EXPORT CONTROL LAWS AND REGULATIONS.				DATE	15/02/2017			
				FIRST ANGLE PROJECTION		SIZE A4	DRAWING NUMBER B3A04E8280011D01	SHEET 1 OF 2

Schema di collegamento - *Connection diagram*
Schemas de branchement - *Schaltplän*
Esquemas de conexión



DTE 01/01/2004
SC - 01 - T - 1v.doc

**Motori trifase una velocità - *Single speed, three phase motors* - Moteurs triphasé une vitesse
Drehstrommotor Eine Drehzahlstufe - Motores trifásico una velocidad**



L1 - L2 - L3 = Linea - *Supply* - Reseau - *Netz* - Red
Per invertire la rotazione invertire due fasi - *To change the rotation reverse two phases* - Pour changer le sens de rotation inverser deux phases - *Zur Drehrichtungsänderung zwei Phasen vertauschen* - Para invertir el sentido de rotación invertir dos fases

Marcatura Morsetti Ausiliari - <i>Additional terminals marking (IEC60034-8)</i>		
Marcatura <i>Marking</i>	No. morsetti <i>terminals</i>	Morsetto ausiliare per: <i>Additional terminal for:</i>
TP1A - TP2A (allarme- <i>warning</i>)	2	Termistori PTC (alta velocità) - <i>Thermistor PTC (high speed) [*]</i>
TP1B - TP2B (allarme- <i>warning</i>)	2	Termistori PTC (bassa velocità) - <i>Thermistor PTC (low speed) [*]</i>
R1 - R2 - R3 (I sensore - <i>sensor</i>)	3	
R4 - R5 - R6 (II sensore - <i>sensor</i>)	3	Termistore PT100 3 fili - <i>Thermistor PT 100 with 3 wires</i>
R7 - R8 - R9 (III sensore - <i>sensor</i>)	3	
R11 - R12 - R13 (anteriore - <i>DE</i>)	3	
R21 - R22 - R23 (posteriore - <i>NDE</i>)	3	Termistore PT100 su cuscinetto - <i>Thermistor PT 100 on bearing</i>
TB1 - TB2 (allarme- <i>warning</i>)	2	Protettore bimetallico normalmente chiuso -
TB3 - TB4 (intervento- <i>switch off</i>)	2	<i>Normally closed bi-metallic switch (**)</i>
TB8 - TB9 (intervento- <i>switch off</i>)	2	Protettore bimetallico del freno normalmente chiuso -
		<i>NC brake bi-metallic switch (**)</i>
TM1 - TM2 (allarme- <i>warning</i>)	2	Protettore bimetallico normalmente aperto -
TM3 - TM4 (intervento- <i>switch off</i>)	2	<i>Normally open bi-metallic switch (**)</i>
HE1- HE2	2	Resistenze riscaldanti - <i>Space heaters</i>
U1 - U2	2	Ventilazione ausiliaria monofase - <i>Single phase forced ventilation</i>
U - V - W	2	Ventilazione ausiliaria trifase - <i>Three phase forced ventilation</i>
colori secondo schema del produttore - <i>colours according manufacturer</i>	9	Encoder
CA1 - CA2	2	Condensatore - <i>Capacitor</i>
PE	1	Conduttore di terra - <i>Earth cable</i>

[*] U nominale - *U rated* = 6V - max 30V(**) U nominale - *U rated* = 250V

FOGLIO DATI PER MOTORI ELETTRICI ASINCRONI TRIFASI : SERIE IEC
DATA SHEET FOR ASYNCHRONOUS THREEPHASE INDUCTION MOTORS: IEC SERIES

Cliente / Customer
Offerta / Offer
Impianto / Plant

DATI DI PROGETTO - DESIGN DATA

Modo di protezione	II2G	Motore / Frame
Type of protection		Scatola morsetti / Terminal box
Tem. Amb. Min. / Min Amb. Temp.	-20 °C	
Umidità relativa / Relative humidity	90%	
Tensione nominale / Rated Voltage	400 V ± 5%	

Ex-db IIC T4 Gb	IP55
Ex-db IIC Gb	IP55
Tem. Amb. Max. / Max Amb. Temp.	40 °C
Altitudine / Altitude	< 1000 mslm / masl
Frequenza / Frequency	50 Hz ± 2%

DATI FUNZIONALI E COSTRUTTIVI - PERFORMANCE AND CONSTRUCTION DATA

1	Quantità / Quantity		01		
2	Motore tipo / Motor type		E3AC30 280MB 4		
3	Numero di serie / Serial Number		-		
4	Forma costruttiva / Shape		B35		
5	Certificato / Certificate	TÜV CY	17 ATEX 0205845 X		
6	Altro certificato / Other certificate				
Dati nominali / Rated data					
7	Poli / Pole	n°	4		
8	Potenza nominale / Rated power	kW	110,00		
9	Corrente nominale / Rated current	A	193,77		
10	Velocità nominale / Full Load speed	1/min	1489		
11	Collegamento / Winding connection		D		
12	Isolamento / Insulation class		F		
13	Sovratemperatura / Temperature rise		80K		
14	Raffreddamento / Cooling type		IC411		
15	Fattore di servizio / Service factor		1		
16					
17	Classe di rendimento / Efficiency level	IEC 34-30	IE3		
Performances elettriche / Electrical performances					
Carico / Load		4/4	3/4	2/4	
18	Giri / Speed	1/min	1489	1491	1494
19	Corr. / Curr.	A	193,77	151,58	101,69
20	Rend / Eff	%	95,5	95,4	94,8
21	cos φ	-	0,86	0,82	0,82
Performances all'avviamento / Starting performances					
22	Ia/In - LRC/FLC	%	715		
23	Cosphi a rotore bloccato / LR power factor		0,30		
Tempo a rotore bloccato / LRWT					
24	100% Un (A caldo / Warm)	sec	11		
25	(A freddo / Cold)	sec	27		
26	80% Un (A caldo / Warm)	sec	17		
27	(A freddo / Cold)	sec	43		
Tempo di avviamento ammissibile / ART					
28	100% Un	sec	24		
29	80% Un	sec	37		
Curva di coppia / Speed-torque values					
30	Coppia nominale / Rated Torque	Nm	705,46		
31	Ca/Cn - LRT/FLT	%	205		
32	Cmax/Cn - BDT/FLT	%	310		
33					
34					
35					
Varie / Other					
36					
37					
38					
39					

Servizio / Duty			
40	Servizio / Duty type	-	S1
41	Intermittenza / Cyclic duration factor	-	-
42	Avviamenti-ora / Starting-hour	-	-
43	Tempo ciclo / Time		-
Cuscinetti / Bearings			
44	Cuscinetto ant / DE bearing	-	6316 ZZ C3
45	Cuscinetto post / NDE bearing	-	6316 ZZ C3
46	Carico radiale max / Max radial load in X1	N	5150
47	Carico assiale max / Max axial load	N	5500
48	Tipo grasso / Grease type		LGHP2 SKF or equivalent
49	Intervallo lubrificazione / Lubrication	h	-
50	Quantità grasso / Quantity grease	gr	-
Caratteristiche meccaniche / mechanical specification			
51	Massa / Mass	kg	1249,6
52	Momento d'inerzia / Moment of inertia	kgm2	2,3954
53	Rumore a vuoto / Noise at no load (1 m)	Lp dB(A)	75
54	Vibrazioni / Vibration level	IEC 34-14	A
55	Limite norma / Vibration limit	mm/sec	2,20
56			
57			
Dati entrata cavi - verniciatura / Cable entry and painting			
63	Entrata cavi / Cable entry		2xM63
64	Ciclo verniciatura / Painting cycle		STD
65	Colore finale / Final colour	RAL	5010
66			
67			
68			
69			
70			
71			
Ausiliari - Auxiliaries			
72	Sonde termiche / Temperature detector	winding	-
73	Sonde termiche / Temperature detector	bearing	-
74	Scaldiglie / Heaters	V / W	-
75	Preparation for SPM sensor		-
76	Pressacavi / Cable glands		NO
77			

**CURVA COPPIA/CORRENTE-GIRI
TORQUE/CURRENT-SPEED DIAGRAM**

Cliente / Customer -
 Impianto / Plant -
ITEM -
 Numero d'offerta / Offer Number -

Motore / Motor **E3AC30 280MB 4**
 Potenza nominale / Rated power 110,00 kW
 Poli / Pole 4
 Tensione - Frequenza / Voltage - Frequency 400 - 50 V - Hz
 Corrente / Rated current 193,77 A
 Velocità / Speed 1489 rpm
 Coppia / Torque 705,46 Nm

— COPPIA - TORQUE — CORRENTE - CURRENT

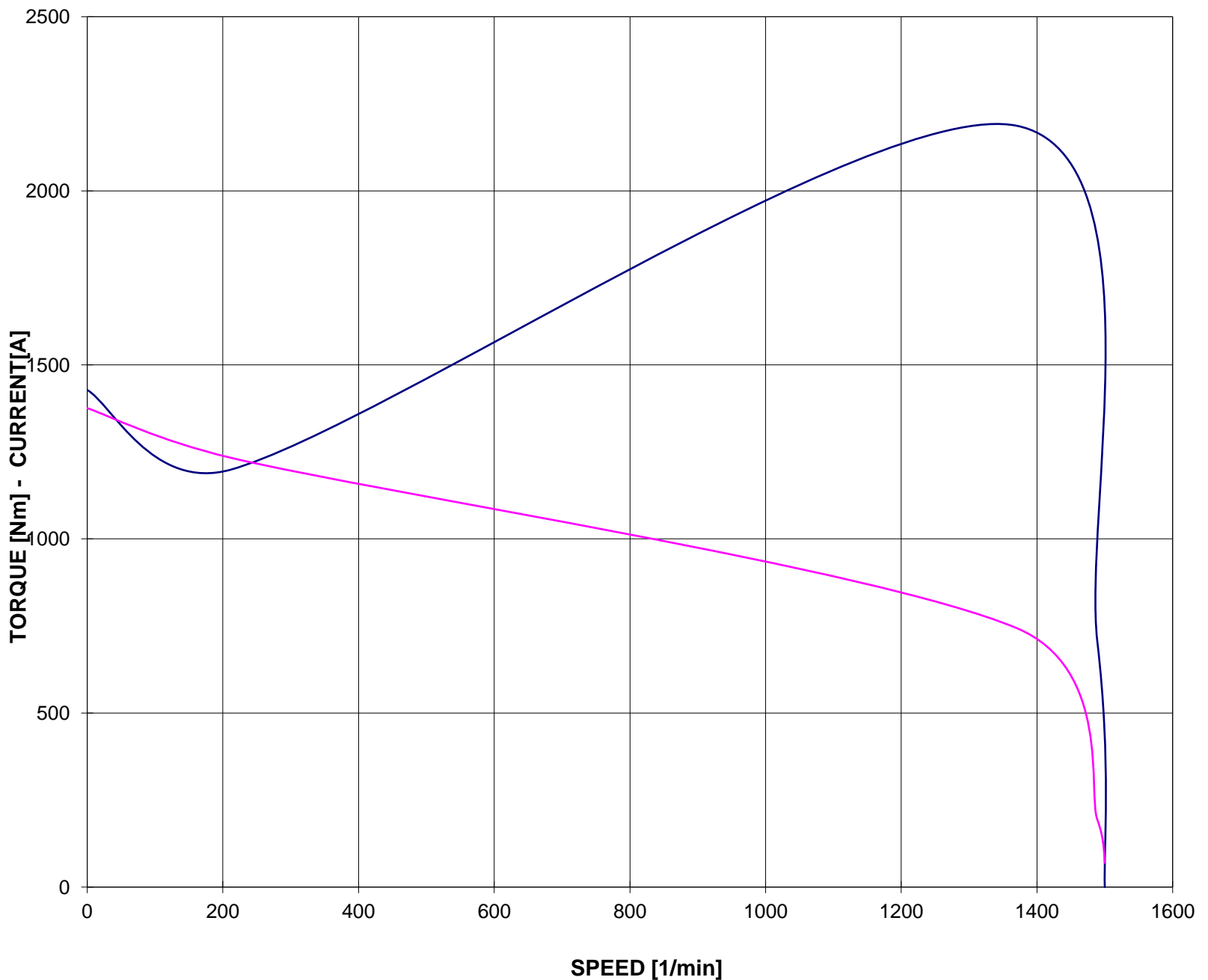

Valori calcolati - Data obtained by calculation method

CURVA COPPIA/CORRENTE-GIRI (Tensione ridotta)
TORQUE/CURRENT-SPEED DIAGRAM (Reduced voltage)

Cliente / Customer -
Impianto / Plant -
ITEM -
Numero d'offerta / Offer Number -

Motore / Motor	E3AC30 280MB 4	
Potenza nominale / Rated power	110,00	kW
Poli / Pole	4	
Tensione - Frequenza / Voltage - Frequency	400 - 50	V - Hz
Corrente / Rated current	193,77	A
Velocità / Speed	1489	rpm
Coppia / Torque	705,46	Nm

— COPPIA - TORQUE — CORRENTE - CURRENT
- - - COPPIA - TORQUE 80% Un - - - CORRENTE - CURRENT 80% Un

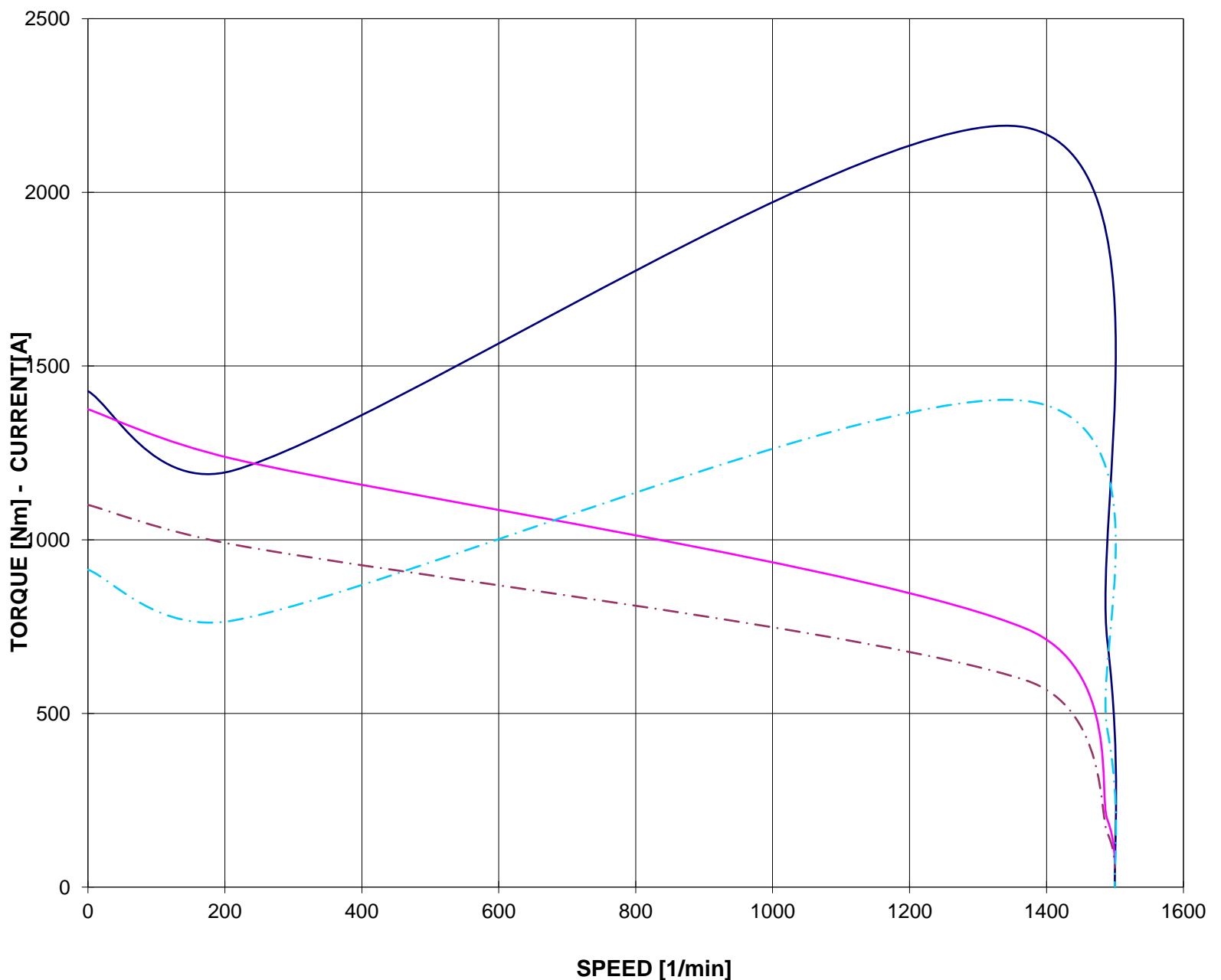

Valori calcolati - Data obtained by calculation method

**CURVE CARATTERISTICHE
PERFORMANCE CURVES**

Cliente / Customer -
Impianto / Plant -
ITEM -
Numero d'offerta / Offer Number -

Motore / Motor **E3AC30 280MB 4**
Potenza nominale / Rated power 110,00 kW
Poli / Pole 4
Tensione - Frequenza / Voltage - Frequency 400 - 50 V - Hz
Corrente / Rated current 193,77 A
Velocità / Speed 1489 rpm
Coppia / Torque 705,46 Nm

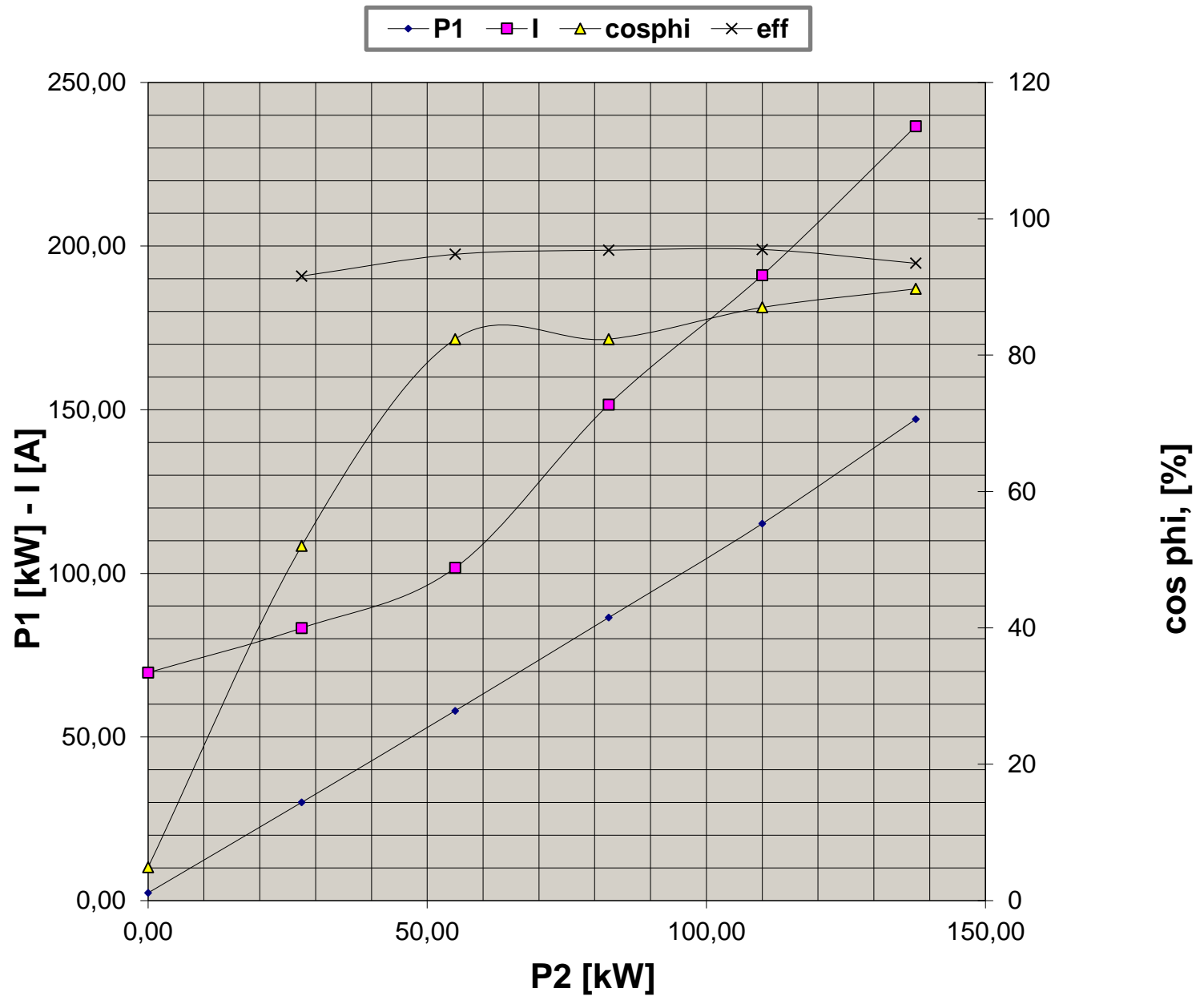

Valori calcolati - Data obtained by calculation method

**CURVA LIMITE CORRENTE TEMPO
THERMAL WITHSTAND CURVE**

Cliente / Customer -
 Impianto / Plant -
ITEM -
 Numero d'offerta / Offer Number -

Motore / Motor **E3AC30 280MB 4**
 Potenza nominale / Rated power 110,00 kW
 Poli / Pole 4
 Tensione - Frequenza / Voltage - Frequency 400 - 50 V - Hz
 Corrente / Rated current 193,77 A
 Velocità / Speed 1489 rpm
 Coppia / Torque 705,46 Nm

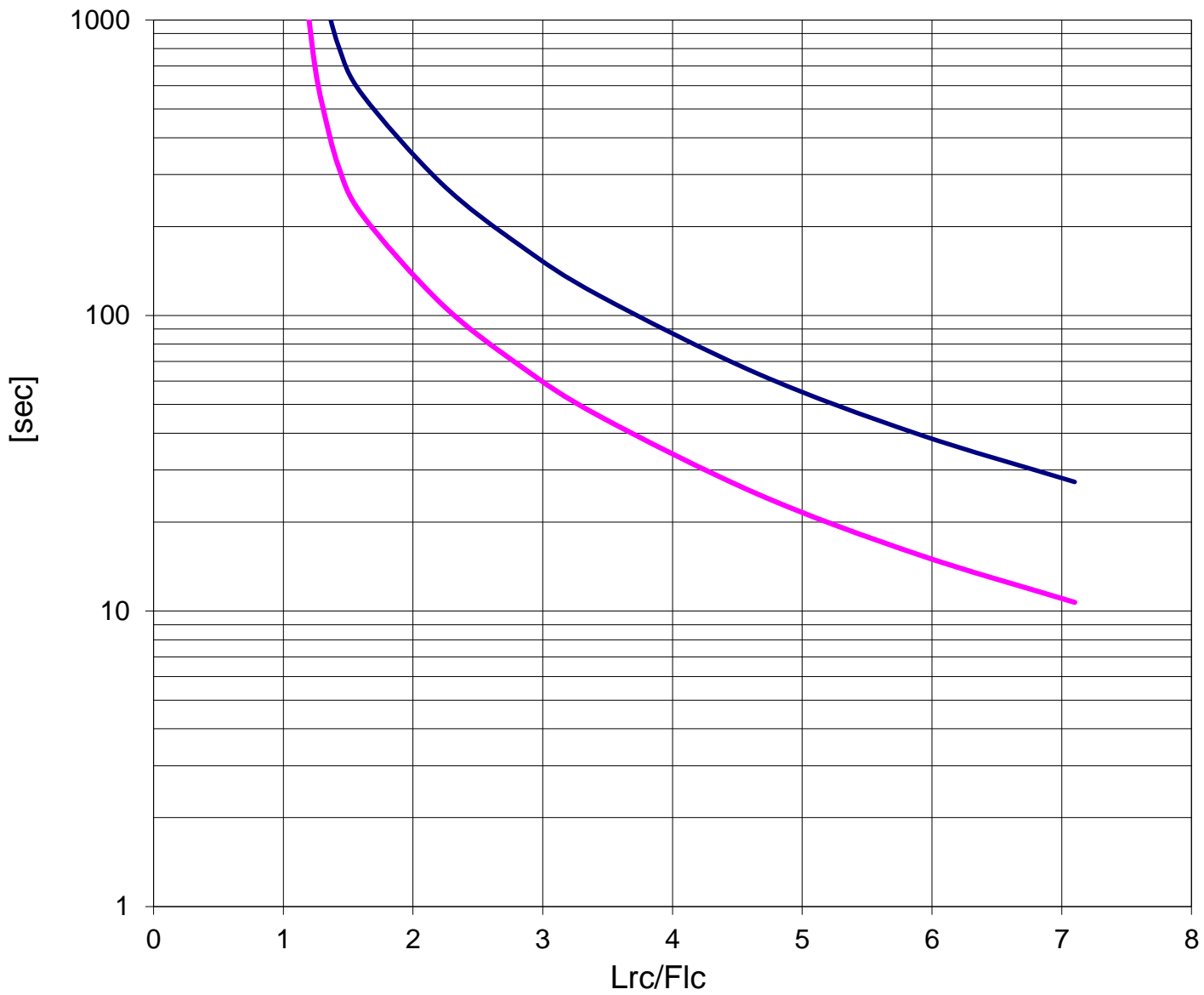

Valori calcolati - Data obtained by calculation method

CURVA LIMITE CORRENTE TEMPO (Tensione ridotta)
THERMAL WITHSTAND CURVE (Reduced voltage)

Cliente / Customer -
Impianto / Plant -
ITEM -
Numero d'offerta / Offer Number -

Motore / Motor **E3AC30 280MB 4**
Potenza nominale / Rated power 110,00 kW
Poli / Pole 4
Tensione - Frequenza / Voltage - Frequency 400 - 50 V - Hz
Corrente / Rated current 193,77 A
Velocità / Speed 1489 rpm
Coppia / Torque 705,46 Nm

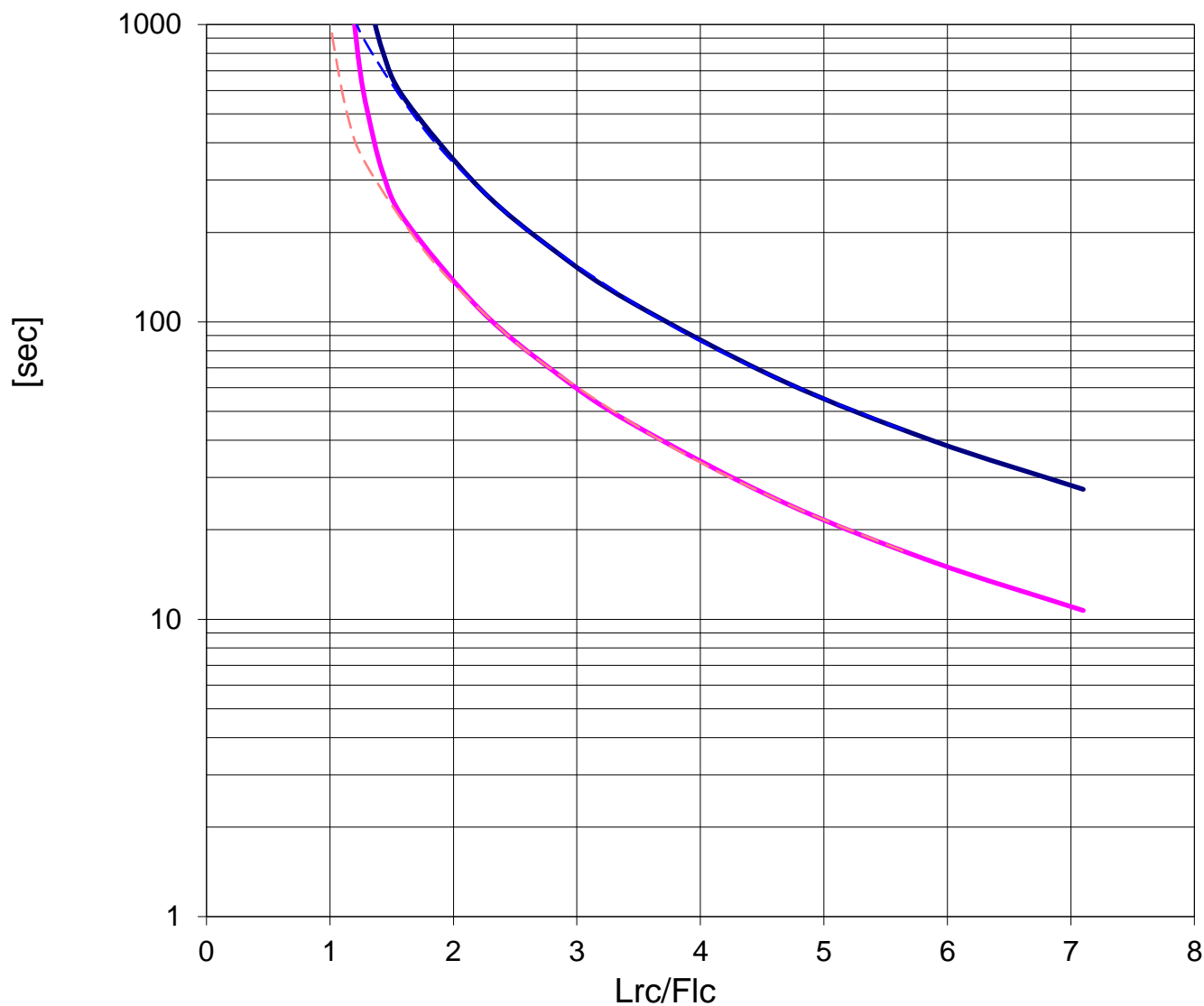
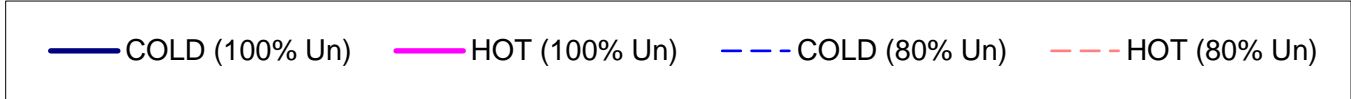

Valori calcolati - Data obtained by calculation method