

PRODUCT INFORMATION PACKET

Model No: E3AC3002163B50D41100

Catalog No: E3AC3002163B50D41100

Made in Italy E3AC30 Series, General Purpose Low Voltage IEC motor IE3, Flameproof, 15,00kW,
3 phase, 2944 RPM, D400/Y690V 50Hz, 160MC Frame B5, 2 Poles, IC411

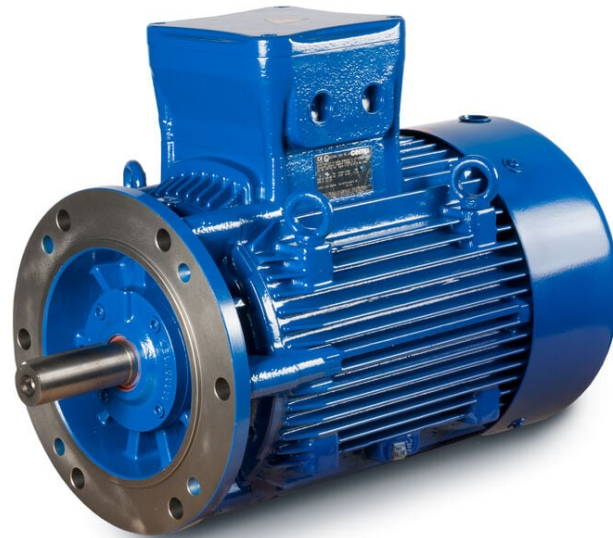

Regal and CEMP are trademarks of Regal Rexnord Corporation or one of its affiliated companies.

©2023 Regal Rexnord Corporation, All Rights Reserved. MC017097E

Nameplate Specifications

Phase	3	Output HP	20 Hp
Output KW	15.0 kW	Voltage	400/690 V
Speed	2944 rpm	Service Factor	1
Frame	160MC	Enclosure	Totally Enclosed Fan Cooled
Efficiency	91.9 %	Ambient Temperature	40 °C
Frequency	50 Hz	Current	26.4 A
Power Factor	0.89	Duty	S1
Insulation Class	F	Drive End Bearing Size	6309
Opp Drive End Bearing Size	6309	UL	No
CSA	Yes	CE	Yes
IP Code	IP55	Number of Speeds	1

Technical Specifications

Electrical Type	Squirrel Cage	Starting Method	Direct On Line
Poles	2	Rotation	Bi-Directional
Mounting	B5	Motor Orientation	Horizontal
Drive End Bearing	Zz C3	Opp Drive End Bearing	Zz C3
Frame Material	Cast Iron	Shaft Type	Keyed
Overall Length	853.00 mm	Frame Length	370.00 mm
Shaft Diameter	42.000 mm	Shaft Extension	110 mm
Assembly/Box Mounting	Top		
Connection Drawing	SC-01-T-1v-1a	Outline Drawing	B5A04E8165001B01

This is an uncontrolled document once printed or downloaded and is subject to change without notice. Date Created:05/03/2023

DETAIL B
SCALE 1 : 1

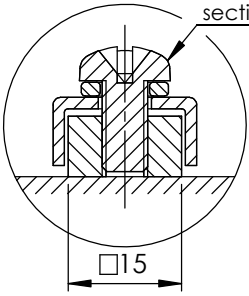

Earth Terminal
suitable for cable
section 2.5-35mm²

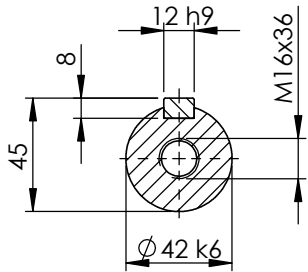

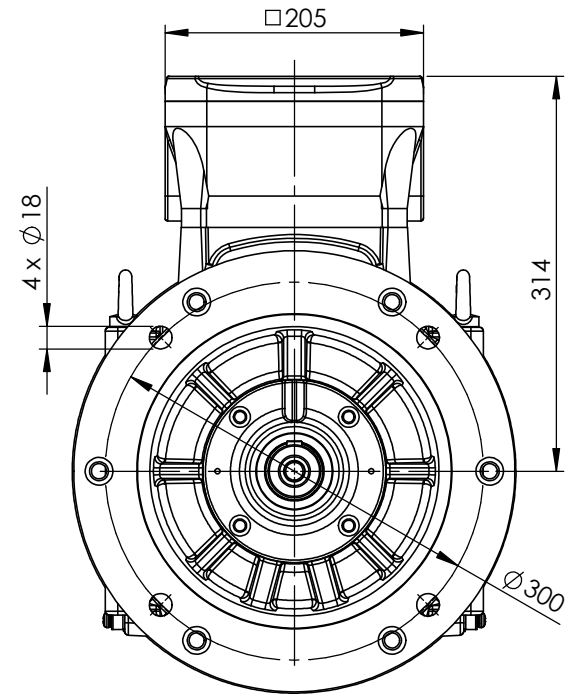
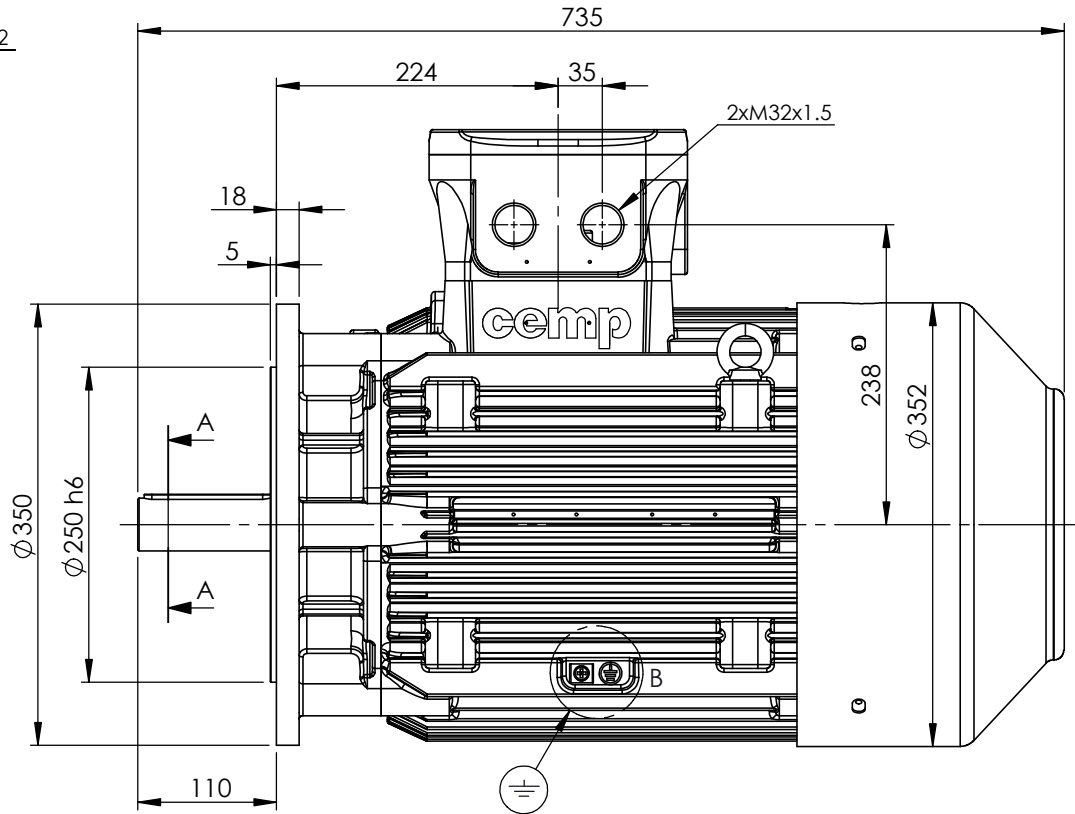

SECTION A-A
SCALE 1 : 3



Earth terminal: 1 in the terminal box, 2 on the frame.

CUSTOMER REFERENCE AND ADDITIONAL INFORMATION:

MOTOR TYPE AND DESCRIPTION:

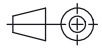
DRAWING REVISION		REVISION BY	DATE	TOLERANCES (EXCEPT AS NOTED) TOLERANCES: ±2 * TOLERANCES: ±0.8	DRAWN BY		 		
ECO		APPROVED BY	DATE		LP			DESCRIPTION	
ECO DESCRIPTION				DIMENSIONS ARE IN mm ACCORDING TO IEC 60072		DATE			
COPYRIGHT CEMP Srl. ALL RIGHTS RESERVED. PROPRIETARY AND CONFIDENTIAL INFORMATION - THIS DOCUMENT IS THE PROPERTY OF CEMP Srl. ("OWNER") AND CONTAINS OWNER'S PROPRIETARY INFORMATION. ANY PERSON, CORPORATION OR OTHER FIRM RECEIVING IT IS DEEMED, BY RECEIVING IT, TO AGREE THAT IT, AND/OR ANY PART OF IT, SHALL NOT BE DISCLOSED TO ANY PERSON, CORPORATION OR OTHER ENTITY, DUPLICATED, AND/OR USED, EXCEPT AS EXPRESSLY APPROVED IN WRITING IN ADVANCE BY OWNER. THIS DOCUMENT SHALL BE RETURNED TO OWNER UPON REQUEST. IT MAY BE SUBJECT TO CERTAIN RESTRICTIONS UNDER APPLICABLE EXPORT CONTROL LAWS AND REGULATIONS.				SERIAL NUMBER		DATE			
				REFERENCE		27/12/2016		Motor A160 M/MB/MC (S) B5 IE3	
				FIRST ANGLE PROJECTION			SIZE A4	DRAWING NUMBER	SHEET
						B5A04E8165001B01		1 OF 2	

Schema di collegamento - *Connection diagram*
Schemas de branchement - *Schaltplän*
Esquemas de conexión



DTE 01/01/2004
SC - 01 - T - 1v.doc

**Motori trifase una velocità - *Single speed, three phase motors* - Moteurs triphasé une vitesse
Drehstrommotor Eine Drehzahlstufe - Motores trifásico una velocidad**



L1 - L2 - L3 = Linea - *Supply* - Reseau - *Netz* - Red
Per invertire la rotazione invertire due fasi - *To change the rotation reverse two phases* - Pour changer le sens de rotation inverser deux phases - *Zur Drehrichtungsänderung zwei Phasen vertauschen* - Para invertir el sentido de rotación invertir dos fases

Marcatura Morsetti Ausiliari - <i>Additional terminals marking (IEC60034-8)</i>		
Marcatura <i>Marking</i>	No. morsetti <i>terminals</i>	Morsetto ausiliare per: <i>Additional terminal for:</i>
TP1A - TP2A (allarme- <i>warning</i>)	2	Termistori PTC (alta velocità) - <i>Thermistor PTC (high speed) [*]</i>
TP1B - TP2B (allarme- <i>warning</i>)	2	Termistori PTC (bassa velocità) - <i>Thermistor PTC (low speed) [*]</i>
R1 - R2 - R3 (I sensore - <i>sensor</i>)	3	
R4 - R5 - R6 (II sensore - <i>sensor</i>)	3	Termistore PT100 3 fili - <i>Thermistor PT 100 with 3 wires</i>
R7 - R8 - R9 (III sensore - <i>sensor</i>)	3	
R11 - R12 - R13 (anteriore - <i>DE</i>)	3	
R21 - R22 - R23 (posteriore - <i>NDE</i>)	3	Termistore PT100 su cuscinetto - <i>Thermistor PT 100 on bearing</i>
TB1 - TB2 (allarme- <i>warning</i>)	2	Protettore bimetallico normalmente chiuso -
TB3 - TB4 (intervento- <i>switch off</i>)	2	<i>Normally closed bi-metallic switch (**)</i>
TB8 - TB9 (intervento- <i>switch off</i>)	2	Protettore bimetallico del freno normalmente chiuso -
		<i>NC brake bi-metallic switch (**)</i>
TM1 - TM2 (allarme- <i>warning</i>)	2	Protettore bimetallico normalmente aperto -
TM3 - TM4 (intervento- <i>switch off</i>)	2	<i>Normally open bi-metallic switch (**)</i>
HE1- HE2	2	Resistenze riscaldanti - <i>Space heaters</i>
U1 - U2	2	Ventilazione ausiliaria monofase - <i>Single phase forced ventilation</i>
U - V - W	2	Ventilazione ausiliaria trifase - <i>Three phase forced ventilation</i>
colori secondo schema del produttore - <i>colours according manufacturer</i>	9	Encoder
CA1 - CA2	2	Condensatore - <i>Capacitor</i>
PE	1	Conduttore di terra - <i>Earth cable</i>

[*] U nominale - *U rated* = 6V - max 30V(**) U nominale - *U rated* = 250V

FOGLIO DATI PER MOTORI ELETTRICI ASINCRONI TRIFASI : SERIE IEC
DATA SHEET FOR ASYNCHRONOUS THREEPHASE INDUCTION MOTORS: IEC SERIES

Cliente / Customer	-
Ordine cliente / Customer order	-
Item	-

Conferma ordine / Acknowledgment	N° -
Impianto / Plant	-

DATI DI PROGETTO - DESIGN DATA

Modo di protezione	II2G	Motore / Frame
Type of protection		Scatola morsetti / Terminal box
Tem. Amb. Min. / Min Amb. Temp.	-20 °C	
Umidità relativa / Relative humidity	90%	
Tensione nominale / Rated Voltage	400 V ± 5%	

Ex-db IIC T4 Gb	IP55
Ex-db IIB Gb	IP55
Tem. Amb. Max. / Max Amb. Temp.	40 °C
Altitudine / Altitude	< 1000 mslm / masl
Frequenza / Frequency	50 Hz ± 2%

DATI FUNZIONALI E COSTRUTTIVI - PERFORMANCE AND CONSTRUCTION DATA

1	Quantità / Quantity		01
2	Motore tipo / Motor type		E3AC30 160MC 2
3	Numero di serie / Serial Number		-
4	Forma costruttiva / Shape		B5
5	Certificato / Certificate	TÜV CY	17 ATEX 0205845 X
6	Altro certificato / Other certificate		
Dati nominali / Rated data			
7	Poli / Pole	n°	2
8	Potenza nominale / Rated power	kW	15,00
9	Corrente nominale / Rated current	A	26,41
10	Velocità nominale / Full Load speed	1/min	2944
11	Collegamento / Winding connection		D
12	Isolamento / Insulation class		F
13	Sovratemperatura / Temperature rise		80K
14	Raffreddamento / Cooling type		IC411
15	Fattore di servizio / Service factor		1
16			
17	Classe di rendimento / Efficiency level	IEC 34-30	IE3
Performances elettriche / Electrical performances			
Carico / Load		4/4	3/4
18	Giri / Speed	1/min	2944
19	Corr. / Curr.	A	26,41
20	Rend / Eff	%	91,9
21	cos φ	-	0,89
Performances all'avviamento / Starting performances			
22	Ia/In - LRC/FLC	%	825
23	Cosphi a rotore bloccato / LR power factor		0,45
Tempo a rotore bloccato / LRWT			
24	100% Un (A caldo / Warm)	sec	6
25	(A freddo / Cold)	sec	15
26	80% Un (A caldo / Warm)	sec	9
27	(A freddo / Cold)	sec	24
Tempo di avviamento ammissibile / ART			
28	100% Un	sec	13
29	80% Un	sec	21
Curva di coppia / Speed-torque values			
30	Coppia nominale / Rated Torque	Nm	48,65
31	Ca/Cn - LRT/FLT	%	220
32	Cmax/Cn - BDT/FLT	%	350
33			
34			
35			
Varie / Other			
36			
37			
38			
39			

Servizio / Duty			
40	Servizio / Duty type	-	S1
41	Intermittenza / Cyclic duration factor	-	-
42	Avviamenti-ora / Starting-hour	-	-
43	Tempo ciclo / Time		-
Cuscinetti / Bearings			
44	Cuscinetto ant / DE bearing	-	6309 ZZ C3
45	Cuscinetto post / NDE bearing	-	6309 ZZ C3
46	Carico radiale max / Max radial load in X1	N	2470
47	Carico assiale max / Max axial load	N	750
48	Tipo grasso / Grease type	LGHP2 SKF or equivalent	
49	Intervallo lubrificazione / Lubrication	h	-
50	Quantità grasso / Quantity grease	gr	-
Caratteristiche meccaniche / mechanical specification			
51	Massa / Mass	kg	209,7
52	Momento d'inerzia / Moment of inertia	kgm2	0,0689
53	Rumore a vuoto / Noise at no load (1 m)	Lp dB(A)	76
54	Vibrazioni / Vibration level	IEC 34-14	A
55	Limite norma / Vibration limit	mm/sec	2,20
56			
57			
Dati entrata cavi - verniciatura / Cable entry and painting			
63	Entrata cavi / Cable entry		2xM32
64	Ciclo verniciatura / Painting cycle		STD
65	Colore finale / Final colour	RAL	5010
66			
67			
68			
69			
70			
71			
Ausiliari - Auxiliaries			
72	Sonde termiche / Temperature detector	winding	-
73	Sonde termiche / Temperature detector	bearing	-
74	Scaldiglie / Heaters	V / W	-
75	Preparation for SPM sensor		-
76	Pressacavi / Cable glands		NO
77			

**CURVA COPPIA/CORRENTE-GIRI
TORQUE/CURRENT-SPEED DIAGRAM**

Cliente / Customer -
 Ordine cliente / Customer order -
 Impianto / Plant -
ITEM -
 Conferma ordine / Acknowledgment -
 Numero di serie / Serial Number -

Motore / Motor **E3AC30 160MC 2**
 Potenza nominale / Rated power 15,00 kW
 Poli / Pole 2
 Tensione - Frequenza / Voltage - Frequency 400 - 50 V - Hz
 Corrente / Rated current 26,41 A
 Velocità / Speed 2944 rpm
 Coppia / Torque 48,65 Nm

— COPPIA - TORQUE — CORRENTE - CURRENT

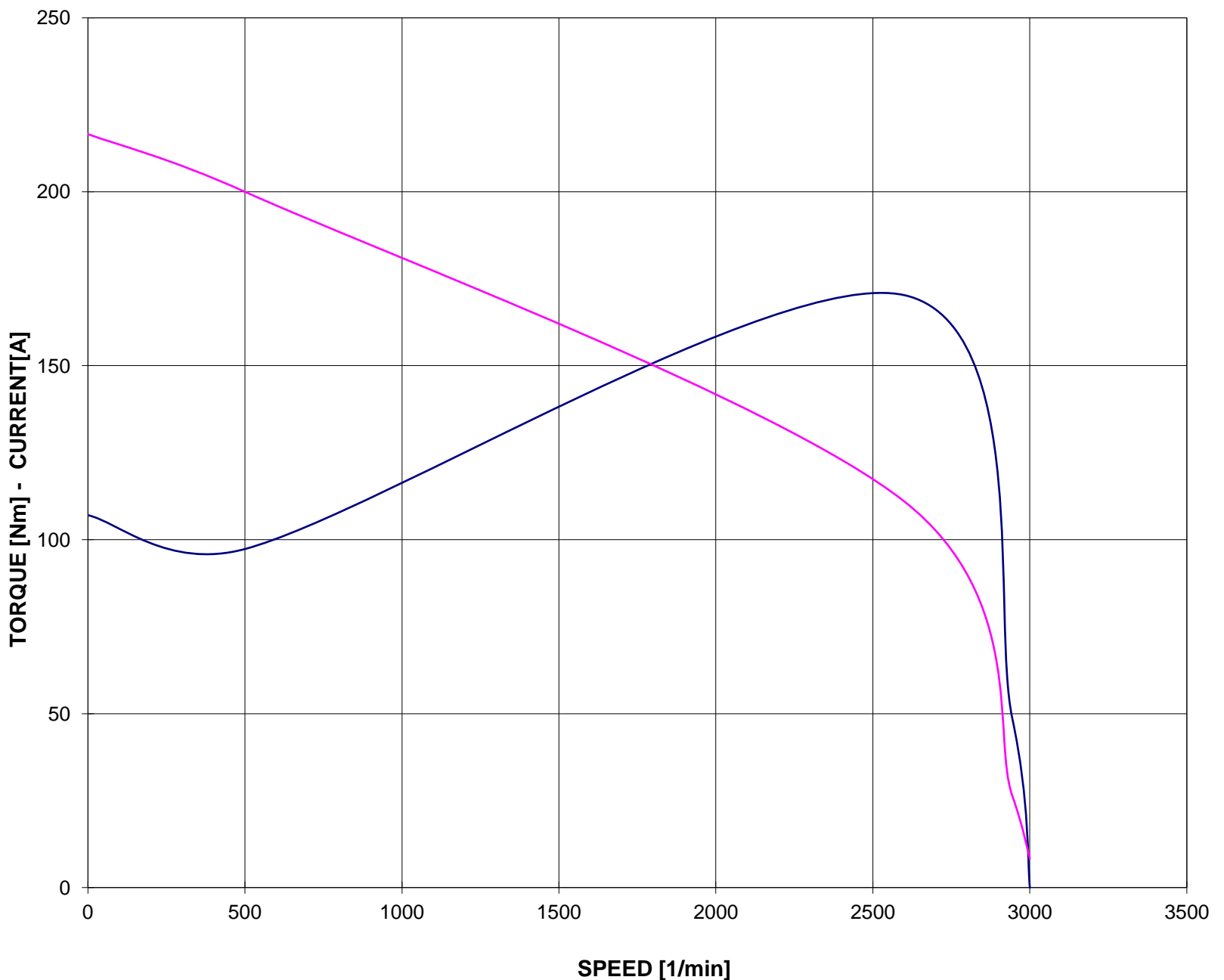

Valori calcolati - Data obtained by calculation method

CURVA COPPIA/CORRENTE-GIRI (Tensione ridotta)
TORQUE/CURRENT-SPEED DIAGRAM (Reduced voltage)

Cliente / Customer -
Ordine cliente / Customer order -
Impianto / Plant -
ITEM -
Conferma ordine / Acknowledgment -
Numero di serie / Serial Number -

Motore / Motor **E3AC30 160MC 2**
Potenza nominale / Rated power 15,00 kW
Poli / Pole 2
Tensione - Frequenza / Voltage - Frequency 400 - 50 V - Hz
Corrente / Rated current 26,41 A
Velocità / Speed 2944 rpm
Coppia / Torque 48,65 Nm

— COPPIA - TORQUE — CORRENTE - CURRENT
- - - COPPIA - TORQUE 80% Un - - - CORRENTE - CURRENT 80% Un

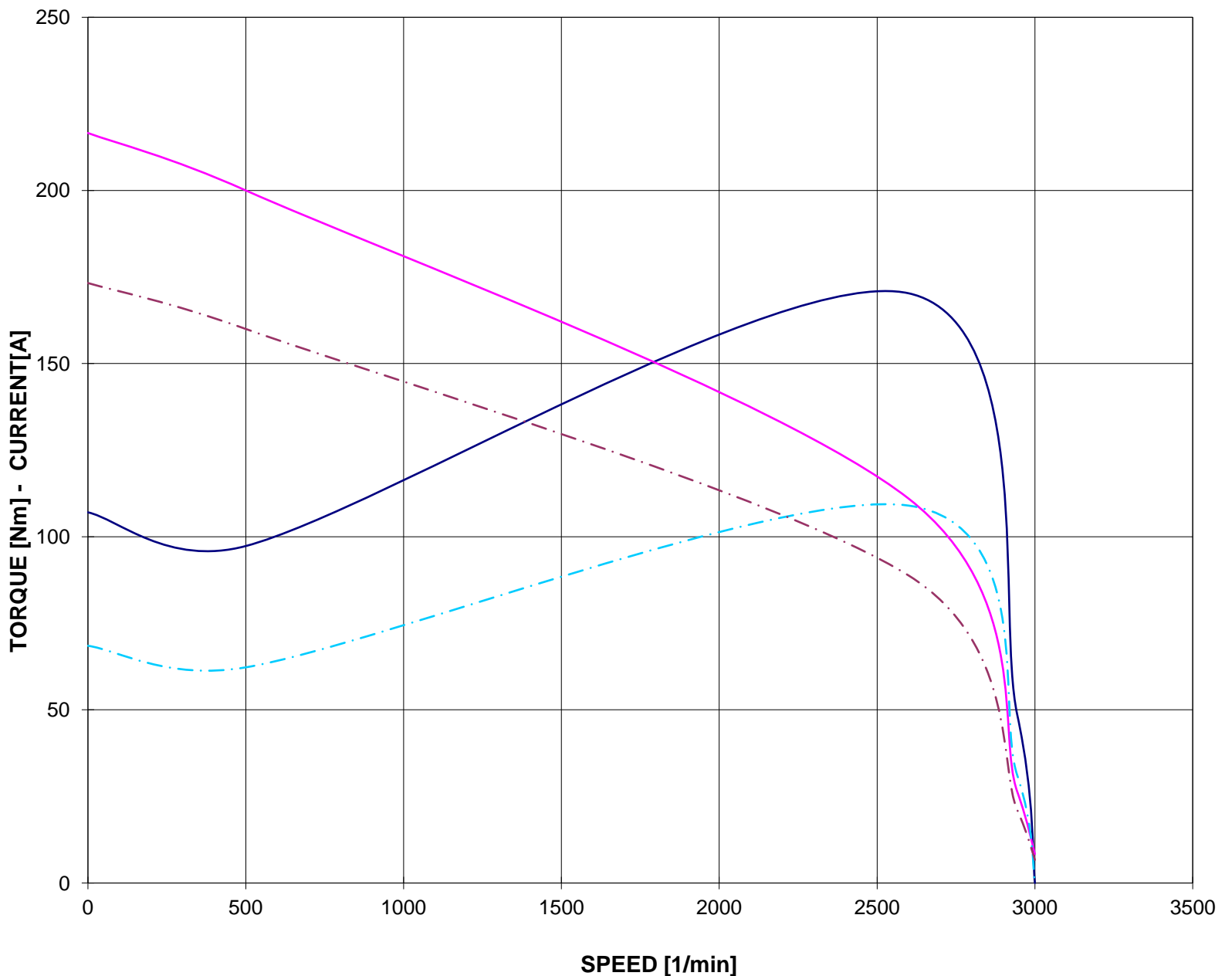

Valori calcolati - Data obtained by calculation method

**CURVE CARATTERISTICHE
PERFORMANCE CURVES**

Cliente / Customer -
 Ordine cliente / Customer order -
 Impianto / Plant -
ITEM -
 Conferma ordine / Acknowledgment -
 Numero di serie / Serial Number -

Motore / Motor **E3AC30 160MC 2**
 Potenza nominale / Rated power 15,00 kW
 Poli / Pole 2
 Tensione - Frequenza / Voltage - Frequency 400 - 50 V - Hz
 Corrente / Rated current 26,41 A
 Velocità / Speed 2944 rpm
 Coppia / Torque 48,65 Nm

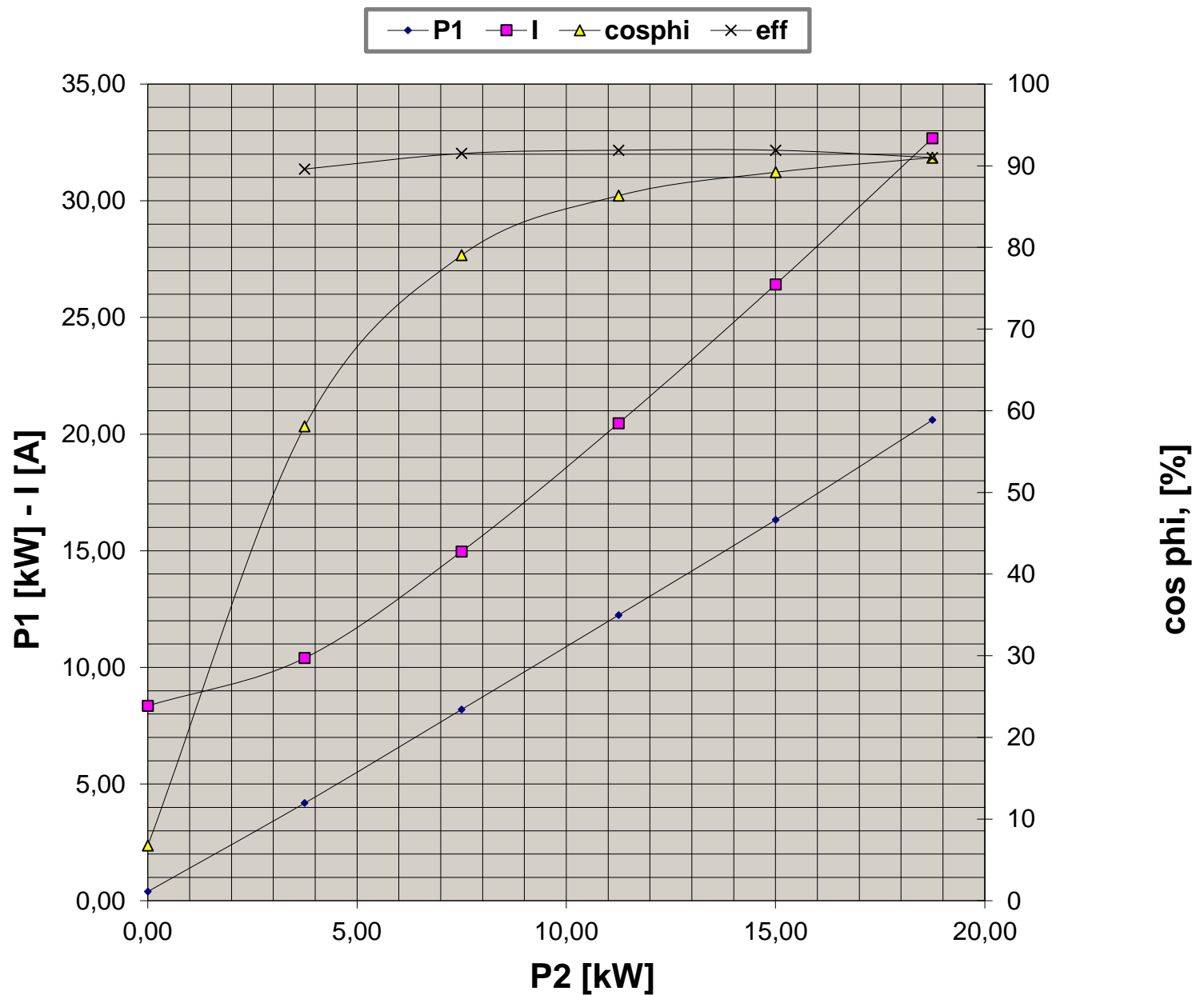

Valori calcolati - Data obtained by calculation method

**CURVA LIMITE CORRENTE TEMPO
THERMAL WITHSTAND CURVE**

Cliente / Customer -
 Ordine cliente / Customer order -
 Impianto / Plant -
ITEM -
 Conferma ordine / Acknowledgment -
 Numero di serie / Serial Number -

Motore / Motor **E3AC30 160MC 2**
 Potenza nominale / Rated power 15,00 kW
 Poli / Pole 2
 Tensione - Frequenza / Voltage - Frequency 400 - 50 V - Hz
 Corrente / Rated current 26,41 A
 Velocità / Speed 2944 rpm
 Coppia / Torque 48,65 Nm

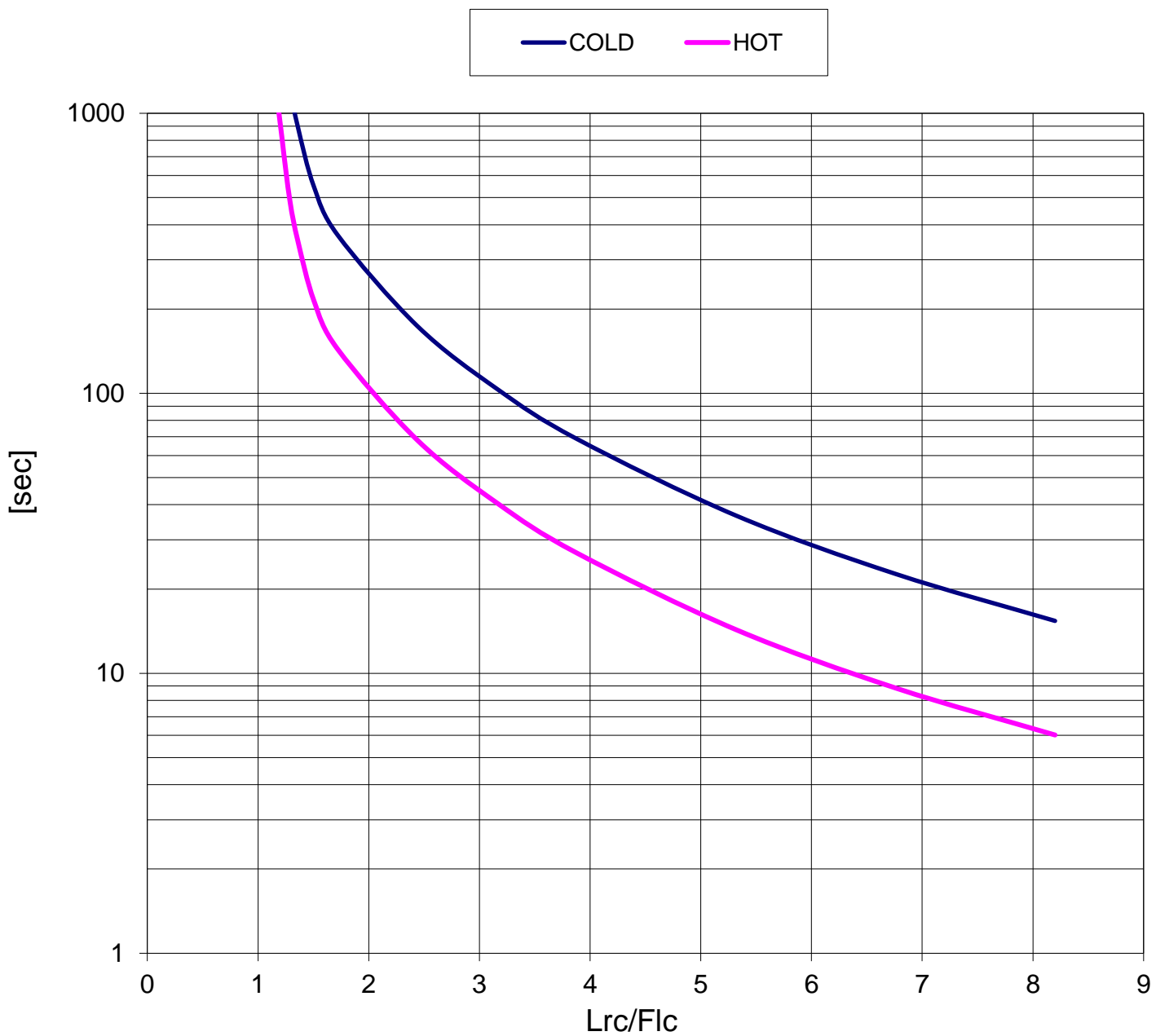

Valori calcolati - Data obtained by calculation method

CURVA LIMITE CORRENTE TEMPO (Tensione ridotta)
THERMAL WITHSTAND CURVE (Reduced voltage)

Cliente / Customer -
 Ordine cliente / Customer order -
 Impianto / Plant -
ITEM -
 Conferma ordine / Acknowledgment -
 Numero di serie / Serial Number -

Motore / Motor	E3AC30 160MC 2	
Potenza nominale / Rated power	15,00	kW
Poli / Pole	2	
Tensione - Frequenza / Voltage - Frequency	400 - 50	V - Hz
Corrente / Rated current	26,41	A
Velocità / Speed	2944	rpm
Coppia / Torque	48,65	Nm

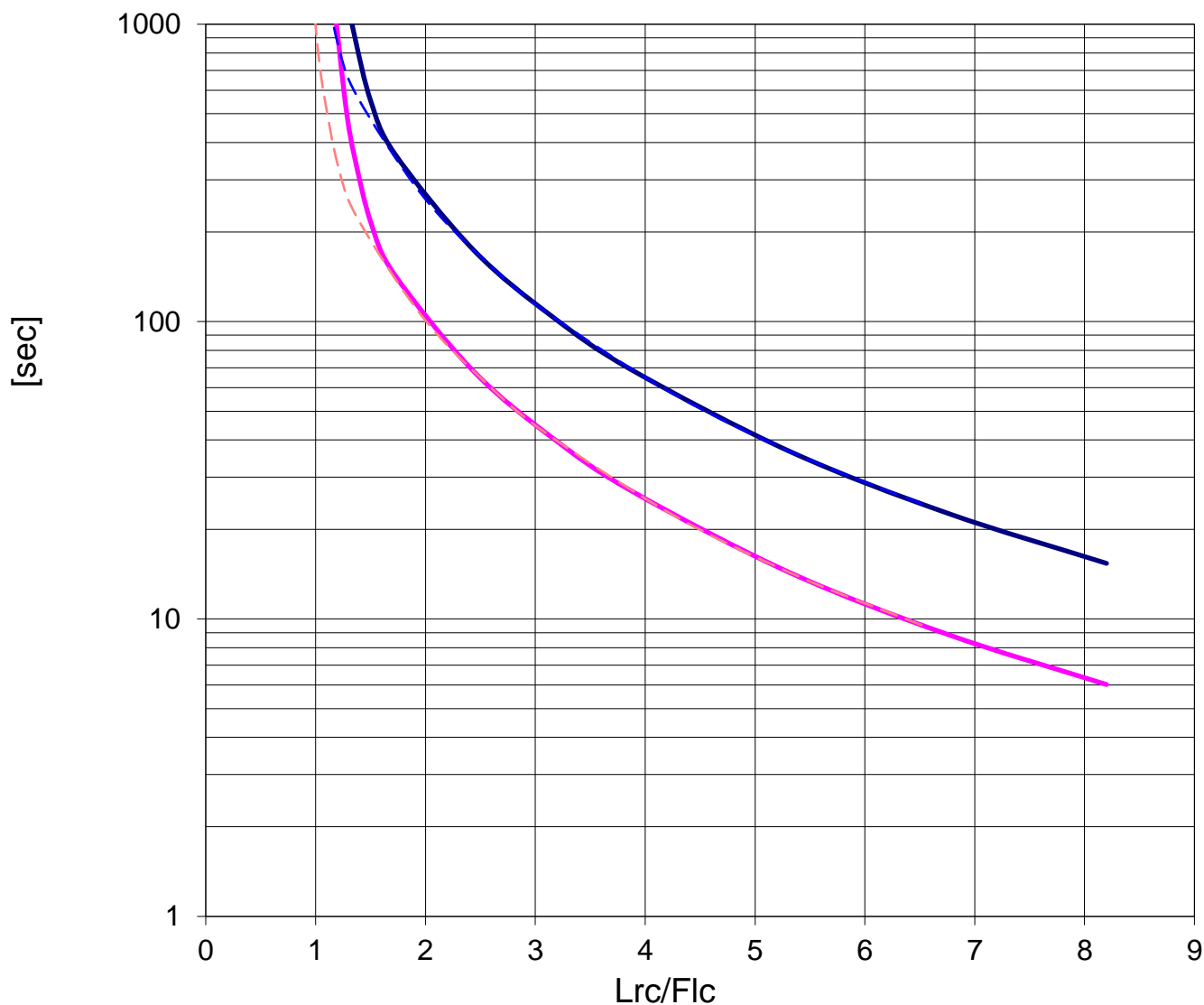
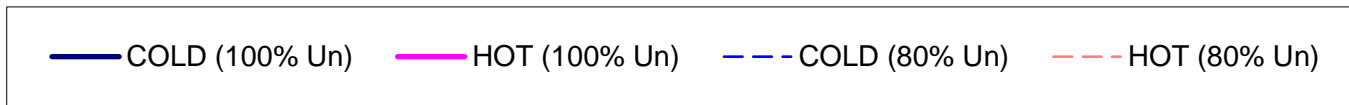

Valori calcolati - Data obtained by calculation method