

PRODUCT INFORMATION PACKET

Model No: E3AB3006167B50D41100

Catalog No: E3AB3006167B50D41100

Made in Italy E3AB30 Series, General Purpose Low Voltage IEC motor IE3, Flameproof, 11,00kW,
3 phase, 977 RPM, D400/Y690V 50Hz, 160LB Frame B5, 6 Poles, IC411

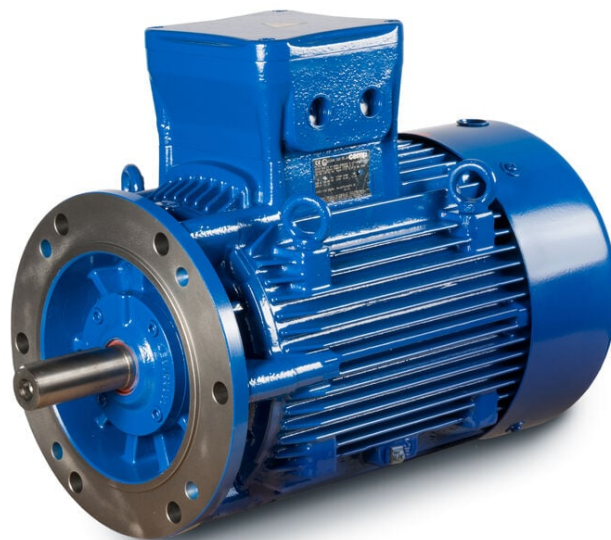

Regal and CEMP are trademarks of Regal Rexnord Corporation or one of its affiliated companies.

©2022 Regal Rexnord Corporation, All Rights Reserved. MC017097E

Nameplate Specifications

Output HP	15 Hp	Output KW	11.0 kW
Frequency	50 Hz	Voltage	400/690 V
Current	21.9 A	Speed	977 rpm
Service Factor	1	Phase	3
Efficiency	90.3 %	Power Factor	0.8
Duty	S1	Insulation Class	F
Frame	160LB	Enclosure	Totally Enclosed Fan Cooled
Ambient Temperature	40 °C	Drive End Bearing Size	6309
Opp Drive End Bearing Size	6309	UL	No
CSA	No	CE	Yes
IP Code	IP55	Number of Speeds	1

Technical Specifications

Electrical Type	Squirrel Cage	Starting Method	Direct On Line
Poles	6	Rotation	Bi-Directional
Mounting	B5	Motor Orientation	Horizontal
Drive End Bearing	Zz C3	Opp Drive End Bearing	Zz C3
Frame Material	Cast Iron	Shaft Type	Keyed
Overall Length	933.00 mm	Frame Length	420.00 mm
Shaft Diameter	42.000 mm	Shaft Extension	110 mm
Assembly/Box Mounting	Top		
Connection Drawing	SC-01-T-1v-1a	Outline Drawing	B5A04E8160001B01

This is an uncontrolled document once printed or downloaded and is subject to change without notice. Date Created:12/02/2022

DETAIL B
SCALE 1 : 1

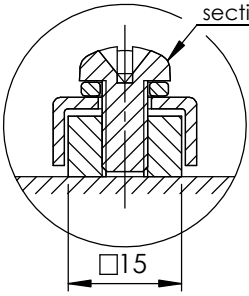

Earth Terminal
suitable for cable
section 2.5-35mm²

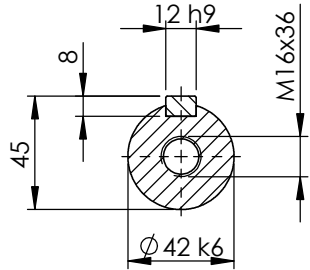

SECTION A-A
SCALE 1 : 3

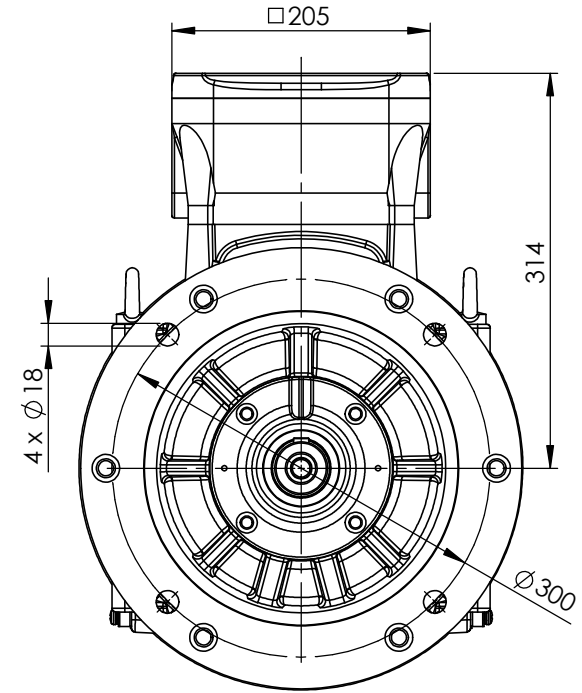
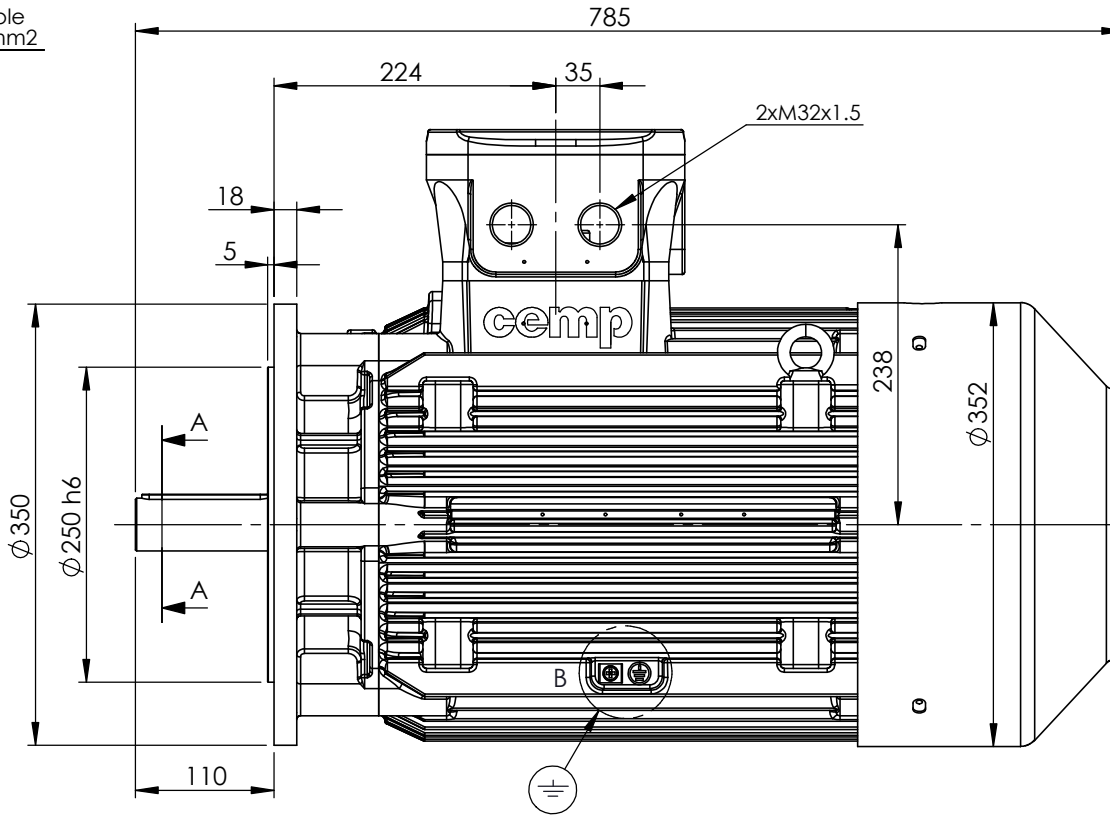

Earth terminal: 1 in the terminal box, 2 on the frame.

CUSTOMER REFERENCE AND ADDITIONAL INFORMATION:

MOTOR TYPE AND DESCRIPTION:

DRAWING REVISION	REVISION BY	DATE
ECO	APPROVED BY	DATE

ECO DESCRIPTION

COPYRIGHT CEMP Srl. ALL RIGHTS RESERVED.
PROPRIETARY AND CONFIDENTIAL INFORMATION - THIS DOCUMENT IS THE PROPERTY OF CEMP Srl. ("OWNER") AND CONTAINS OWNER'S PROPRIETARY INFORMATION. ANY PERSON, CORPORATION OR OTHER FIRM RECEIVING IT IS DEEMED, BY RECEIVING IT, TO AGREE THAT IT, AND/OR ANY PART OF IT, SHALL NOT BE DISCLOSED TO ANY PERSON, CORPORATION OR OTHER ENTITY, DUPLICATED, AND/OR USED, EXCEPT AS EXPRESSLY APPROVED IN WRITING IN ADVANCE BY OWNER. THIS DOCUMENT SHALL BE RETURNED TO OWNER UPON REQUEST. IT MAY BE SUBJECT TO CERTAIN RESTRICTIONS UNDER APPLICABLE EXPORT CONTROL LAWS AND REGULATIONS.



TOLERANCES (EXCEPT AS NOTED)
TOLERANCES: ±2
* TOLERANCES: ±0.8
DIMENSIONS ARE IN mm
ACCORDING TO IEC 60072

SERIAL NUMBER

DRAWN BY	LP
DATE	27/12/2016
APPROVED BY	DP
DATE	27/12/2016
REFERENCE	

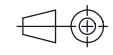
FIRST ANGLE PROJECTION



 	
DESCRIPTION	
Motor A160 LA/LB (L) B5 IE3	
SIZE	DRAWING NUMBER
A4	B5A04E8160001B01
SHEET	
1 OF 2	

Schema di collegamento - *Connection diagram*
Schemas de branchement - *Schaltplän*
Esquemas de conexión



DTE 01/01/2004
SC - 01 - T - 1v.doc

**Motori trifase una velocità - *Single speed, three phase motors* - Moteurs triphasé une vitesse
Drehstrommotor Eine Drehzahlstufe - Motores trifásico una velocidad**



L1 - L2 - L3 = Linea - *Supply* - Reseau - *Netz* - Red
Per invertire la rotazione invertire due fasi - *To change the rotation reverse two phases* - Pour changer le sens de rotation inverser deux phases - *Zur Drehrichtungsänderung zwei Phasen vertauschen* - Para invertir el sentido de rotación invertir dos fases

Marcatura Morsetti Ausiliari - <i>Additional terminals marking (IEC60034-8)</i>		
Marcatura <i>Marking</i>	No. morsetti <i>terminals</i>	Morsetto ausiliare per: <i>Additional terminal for:</i>
TP1A - TP2A (allarme- <i>warning</i>)	2	Termistori PTC (alta velocità) - <i>Thermistor PTC (high speed) [*]</i>
TP1B - TP2B (allarme- <i>warning</i>)	2	Termistori PTC (bassa velocità) - <i>Thermistor PTC (low speed) [*]</i>
R1 - R2 - R3 (I sensore - <i>sensor</i>)	3	
R4 - R5 - R6 (II sensore - <i>sensor</i>)	3	Termistore PT100 3 fili - <i>Thermistor PT 100 with 3 wires</i>
R7 - R8 - R9 (III sensore - <i>sensor</i>)	3	
R11 - R12 - R13 (anteriore - <i>DE</i>)	3	
R21 - R22 - R23 (posteriore - <i>NDE</i>)	3	Termistore PT100 su cuscinetto - <i>Thermistor PT 100 on bearing</i>
TB1 - TB2 (allarme- <i>warning</i>)	2	Protettore bimetallico normalmente chiuso -
TB3 - TB4 (intervento- <i>switch off</i>)	2	<i>Normally closed bi-metallic switch (**)</i>
TB8 - TB9 (intervento- <i>switch off</i>)	2	Protettore bimetallico del freno normalmente chiuso -
		<i>NC brake bi-metallic switch (**)</i>
TM1 - TM2 (allarme- <i>warning</i>)	2	Protettore bimetallico normalmente aperto -
TM3 - TM4 (intervento- <i>switch off</i>)	2	<i>Normally open bi-metallic switch (**)</i>
HE1- HE2	2	Resistenze riscaldanti - <i>Space heaters</i>
U1 - U2	2	Ventilazione ausiliaria monofase - <i>Single phase forced ventilation</i>
U - V - W	2	Ventilazione ausiliaria trifase - <i>Three phase forced ventilation</i>
colori secondo schema del produttore - <i>colours according manufacturer</i>	9	Encoder
CA1 - CA2	2	Condensatore - <i>Capacitor</i>
PE	1	Conduttore di terra - <i>Earth cable</i>

[*] U nominale - *U rated* = 6V - max 30V(**) U nominale - *U rated* = 250V

FOGLIO DATI PER MOTORI ELETTRICI ASINCRONI TRIFASI : SERIE IEC
DATA SHEET FOR ASYNCHRONOUS THREEPHASE INDUCTION MOTORS: IEC SERIES

Cliente / Customer	-
Ordine cliente / Customer order	-
Item	-

Conferma ordine / Acknowledgment	N° -
Impianto / Plant	-

DATI DI PROGETTO - DESIGN DATA

Modo di protezione	II2G	Motore / Frame
Type of protection		Scatola morsetti / Terminal box
Tem. Amb. Min. / Min Amb. Temp.	-20 °C	
Umidità relativa / Relative humidity	90%	
Tensione nominale / Rated Voltage	400 V ± 5%	

Ex-db IIB T4 Gb	IP55
Ex-db IIB Gb	IP55
Tem. Amb. Max. / Max Amb. Temp.	40 °C
Altitudine / Altitude	< 1000 mslm / masl
Frequenza / Frequency	50 Hz ± 2%

DATI FUNZIONALI E COSTRUTTIVI - PERFORMANCE AND CONSTRUCTION DATA

1	Quantità / Quantity		01
2	Motore tipo / Motor type		E3AB30 160LB 6
3	Numero di serie / Serial Number		-
4	Forma costruttiva / Shape		B5
5	Certificato / Certificate	TÜV CY	17 ATEX 0205845 X
6	Altro certificato / Other certificate		
Dati nominali / Rated data			
7	Poli / Pole	n°	6
8	Potenza nominale / Rated power	kW	11,00
9	Corrente nominale / Rated current	A	21,87
10	Velocità nominale / Full Load speed	1/min	977
11	Collegamento / Winding connection		D
12	Isolamento / Insulation class		F
13	Sovratemperatura / Temperature rise		80K
14	Raffreddamento / Cooling type		IC411
15	Fattore di servizio / Service factor		1
16			
17	Classe di rendimento / Efficiency level	IEC 34-30	IE3
Performances elettriche / Electrical performances			
Carico / Load		4/4	3/4
18	Giri / Speed	1/min	977
19	Corr. / Curr.	A	21,87
20	Rend / Eff	%	90,0
21	cos φ	-	0,78
Performances all'avviamento / Starting performances			
22	Ia/In - LRC/FLC	%	595
23	Cosphi a rotore bloccato / LR power factor		0,44
Tempo a rotore bloccato / LRWT			
24	100% Un (A caldo / Warm)	sec	7
25	(A freddo / Cold)	sec	19
26	80% Un (A caldo / Warm)	sec	11
27	(A freddo / Cold)	sec	30
Tempo di avviamento ammissibile / ART			
28	100% Un	sec	17
29	80% Un	sec	26
Curva di coppia / Speed-torque values			
30	Coppia nominale / Rated Torque	Nm	107,52
31	Ca/Cn - LRT/FLT	%	210
32	Cmax/Cn - BDT/FLT	%	270
33			
34			
35			
Varie / Other			
36			
37			
38			
39			

Servizio / Duty			
40	Servizio / Duty type	-	S1
41	Intermittenza / Cyclic duration factor	-	-
42	Avviamenti-ora / Starting-hour	-	-
43	Tempo ciclo / Time		-
Cuscinetti / Bearings			
44	Cuscinetto ant / DE bearing	-	6309 ZZ C3
45	Cuscinetto post / NDE bearing	-	6309 ZZ C3
46	Carico radiale max / Max radial load in X1	N	2790
47	Carico assiale max / Max axial load	N	880
48	Tipo grasso / Grease type	LGHP2 SKF or equivalent	
49	Intervallo lubrificazione / Lubrication	h	-
50	Quantità grasso / Quantity grease	gr	-
Caratteristiche meccaniche / mechanical specification			
51	Massa / Mass	kg	250,7
52	Momento d'inerzia / Moment of inertia	kgm2	0,1907
53	Rumore a vuoto / Noise at no load (1 m)	Lp dB(A)	67
54	Vibrazioni / Vibration level	IEC 34-14	A
55	Limite norma / Vibration limit	mm/sec	2,20
56			
57			
Dati entrata cavi - verniciatura / Cable entry and painting			
63	Entrata cavi / Cable entry		2xM32
64	Ciclo verniciatura / Painting cycle		STD
65	Colore finale / Final colour	RAL	5010
66			
67			
68			
69			
70			
71			
Ausiliari - Auxiliaries			
72	Sonde termiche / Temperature detector	winding	-
73	Sonde termiche / Temperature detector	bearing	-
74	Scaldiglie / Heaters	V / W	-
75	Preparation for SPM sensor		-
76	Pressacavi / Cable glands		NO
77			

**CURVA COPPIA/CORRENTE-GIRI
TORQUE/CURRENT-SPEED DIAGRAM**

Cliente / Customer -
 Ordine cliente / Customer order -
 Impianto / Plant -
ITEM -
 Conferma ordine / Acknowledgment -
 Numero di serie / Serial Number -

Motore / Motor **E3AB30 160LB 6**
 Potenza nominale / Rated power 11,00 kW
 Poli / Pole 6
 Tensione - Frequenza / Voltage - Frequency 400 - 50 V - Hz
 Corrente / Rated current 21,87 A
 Velocità / Speed 977 rpm
 Coppia / Torque 107,52 Nm

— COPPIA - TORQUE — CORRENTE - CURRENT

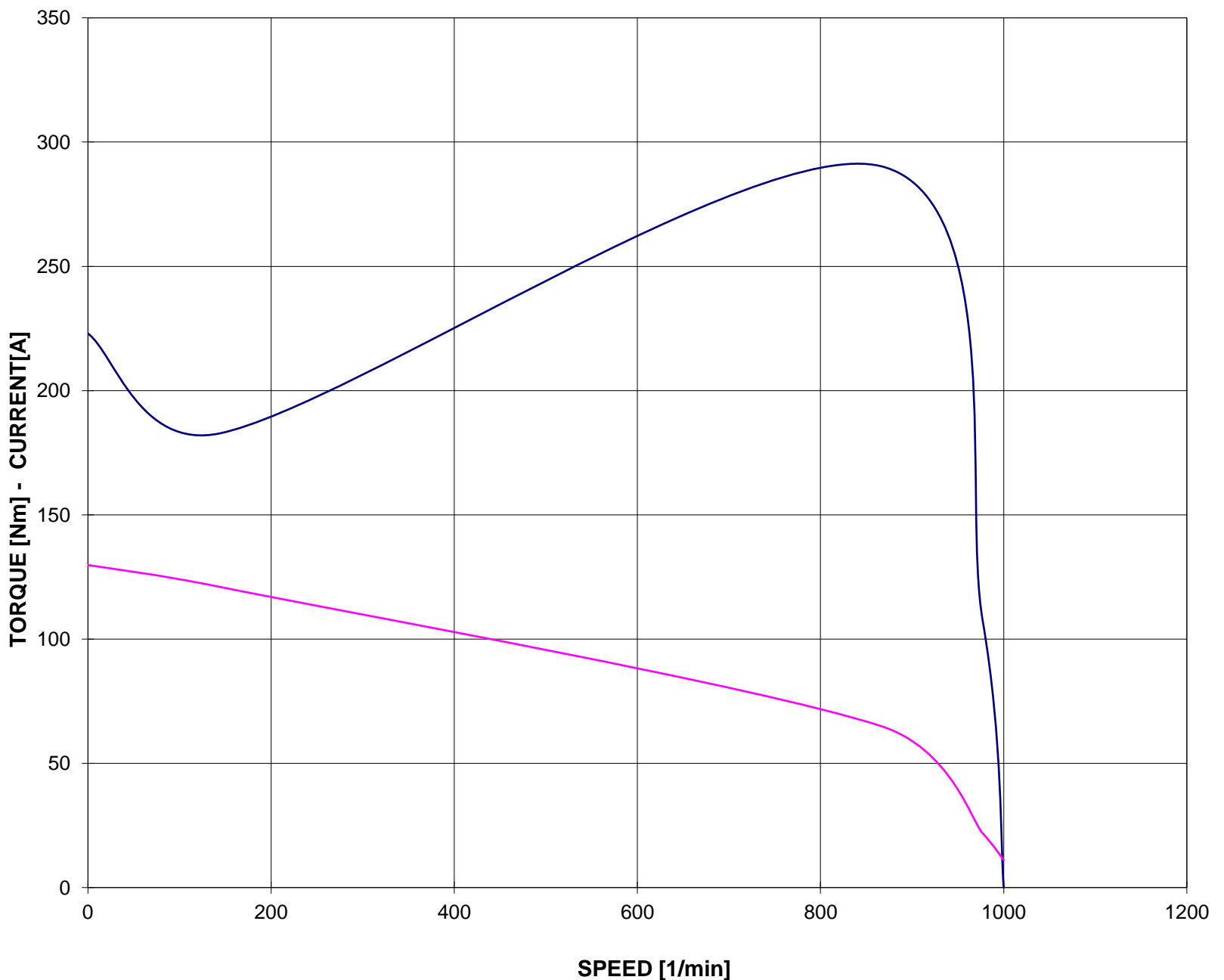

Valori calcolati - Data obtained by calculation method

CURVA COPPIA/CORRENTE-GIRI (Tensione ridotta)
TORQUE/CURRENT-SPEED DIAGRAM (Reduced voltage)

Cliente / Customer -
Ordine cliente / Customer order -
Impianto / Plant -
ITEM -
Conferma ordine / Acknowledgment -
Numero di serie / Serial Number -

Motore / Motor **E3AB30 160LB 6**
Potenza nominale / Rated power 11,00 kW
Poli / Pole 6
Tensione - Frequenza / Voltage - Frequency 400 - 50 V - Hz
Corrente / Rated current 21,87 A
Velocità / Speed 977 rpm
Coppia / Torque 107,52 Nm

— COPPIA - TORQUE — CORRENTE - CURRENT
- - - COPPIA - TORQUE 80% Un - - - CORRENTE - CURRENT 80% Un

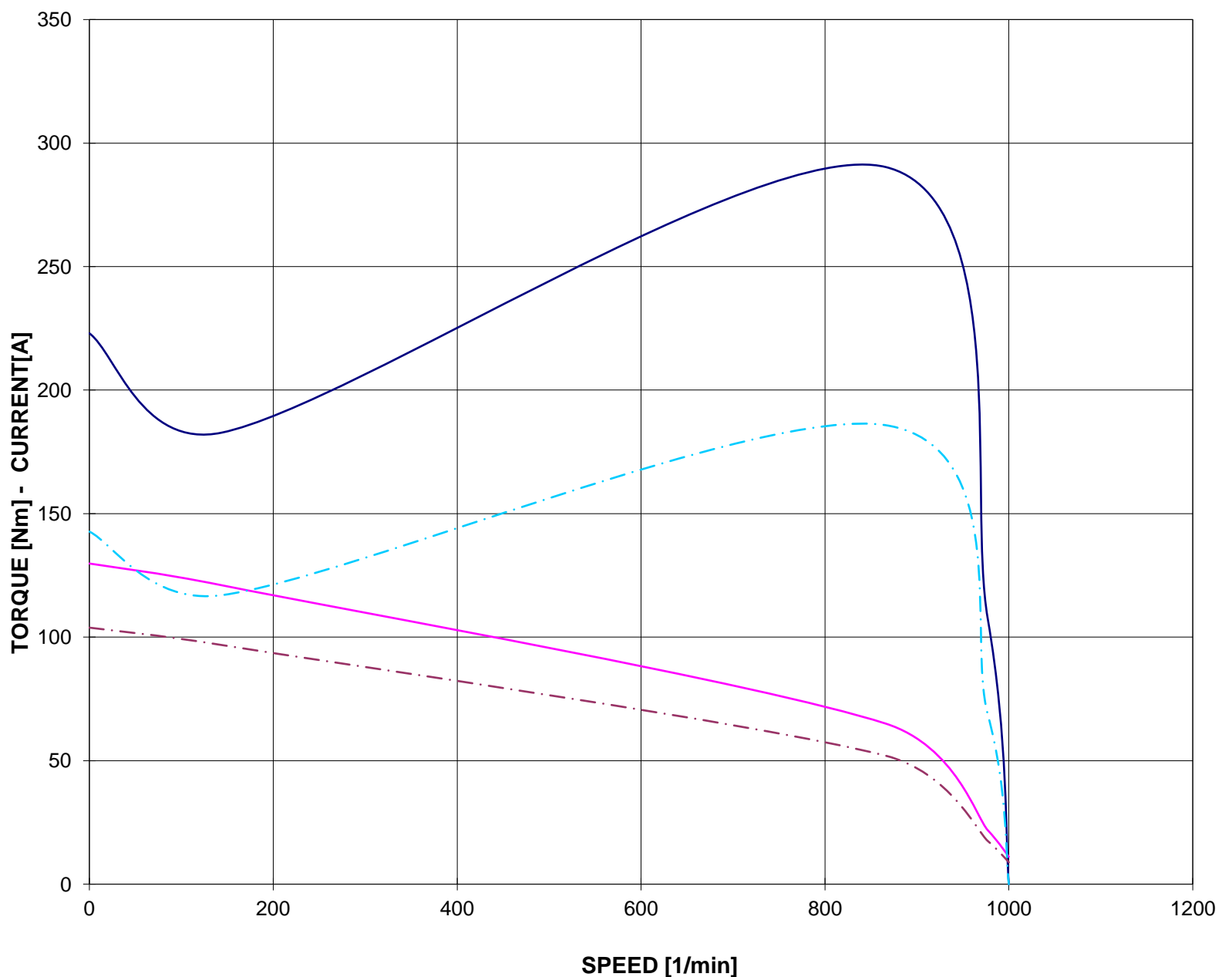

Valori calcolati - Data obtained by calculation method

**CURVE CARATTERISTICHE
PERFORMANCE CURVES**

Cliente / Customer -
 Ordine cliente / Customer order -
 Impianto / Plant -
ITEM -
 Conferma ordine / Acknowledgment -
 Numero di serie / Serial Number -

Motore / Motor **E3AB30 160LB 6**
 Potenza nominale / Rated power 11,00 kW
 Poli / Pole 6
 Tensione - Frequenza / Voltage - Frequency 400 - 50 V - Hz
 Corrente / Rated current 21,87 A
 Velocità / Speed 977 rpm
 Coppia / Torque 107,52 Nm

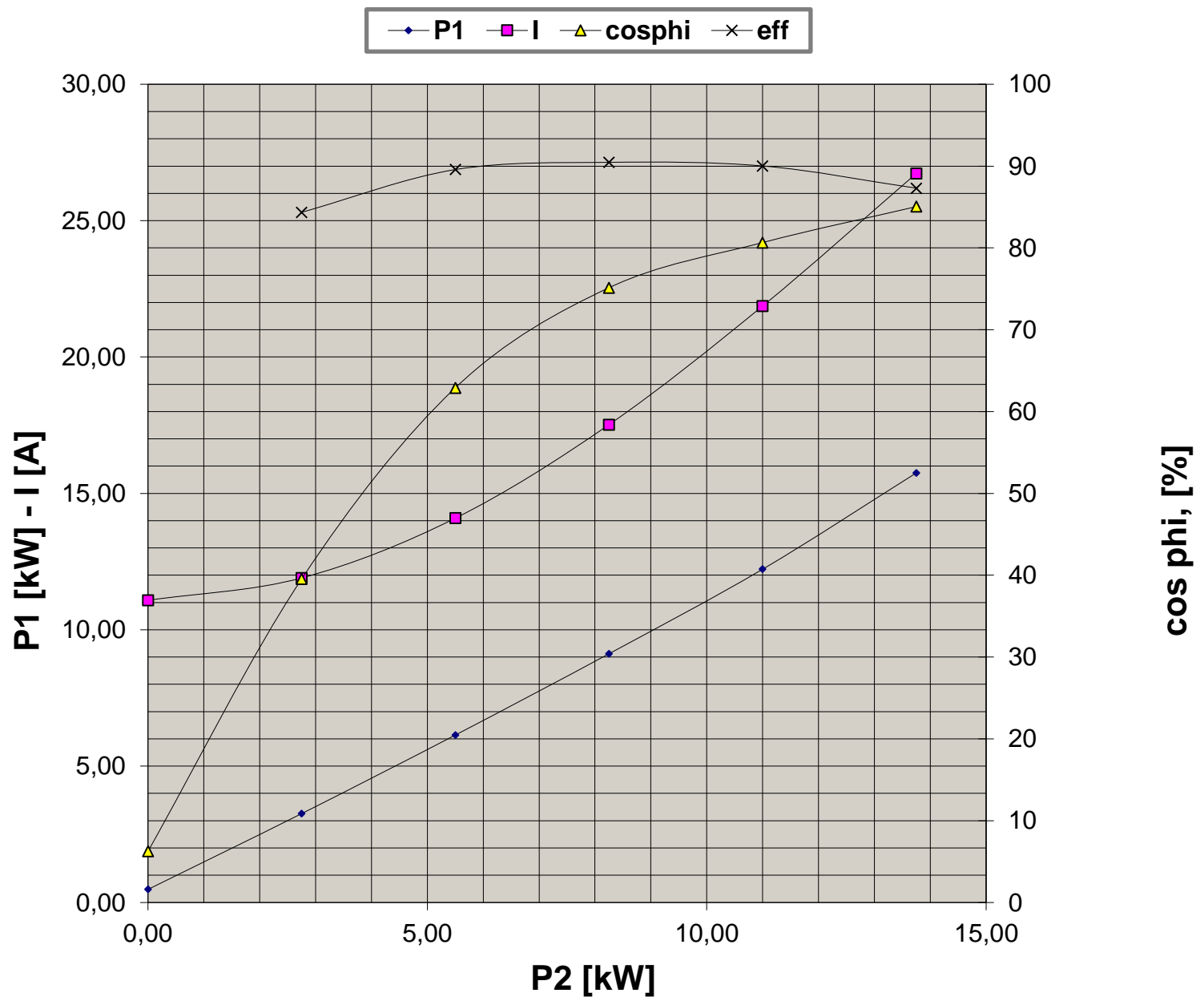

Valori calcolati - Data obtained by calculation method

**CURVA LIMITE CORRENTE TEMPO
THERMAL WITHSTAND CURVE**

Cliente / Customer -
 Ordine cliente / Customer order -
 Impianto / Plant -
ITEM -
 Conferma ordine / Acknowledgment -
 Numero di serie / Serial Number -

Motore / Motor **E3AB30 160LB 6**
 Potenza nominale / Rated power 11,00 kW
 Poli / Pole 6
 Tensione - Frequenza / Voltage - Frequency 400 - 50 V - Hz
 Corrente / Rated current 21,87 A
 Velocità / Speed 977 rpm
 Coppia / Torque 107,52 Nm

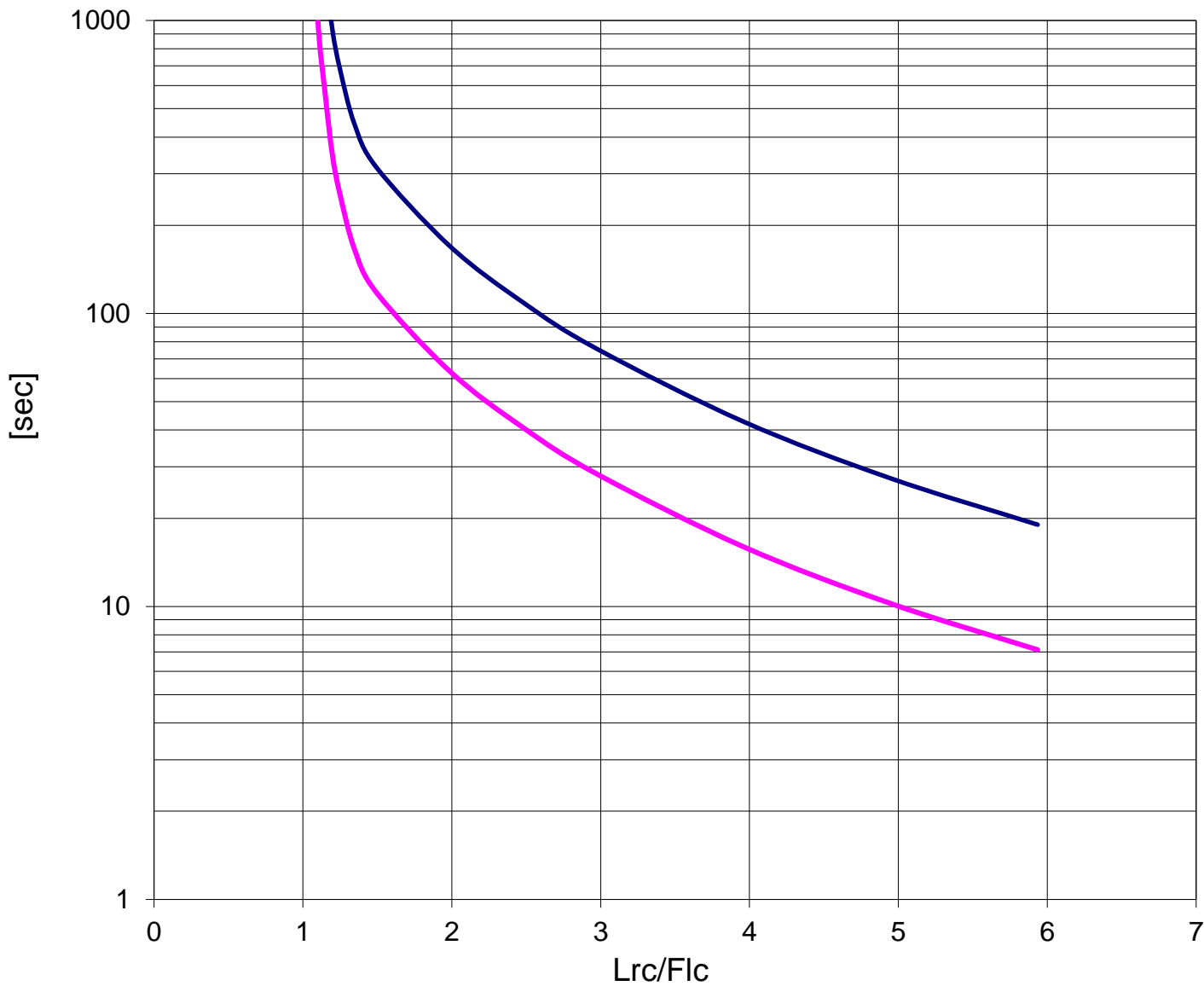

Valori calcolati - Data obtained by calculation method

CURVA LIMITE CORRENTE TEMPO (Tensione ridotta)
THERMAL WITHSTAND CURVE (Reduced voltage)

Cliente / Customer -
 Ordine cliente / Customer order -
 Impianto / Plant -
ITEM -
 Conferma ordine / Acknowledgment -
 Numero di serie / Serial Number -

Motore / Motor **E3AB30 160LB 6**
 Potenza nominale / Rated power 11,00 kW
 Poli / Pole 6
 Tensione - Frequenza / Voltage - Frequency 400 - 50 V - Hz
 Corrente / Rated current 21,87 A
 Velocità / Speed 977 rpm
 Coppia / Torque 107,52 Nm

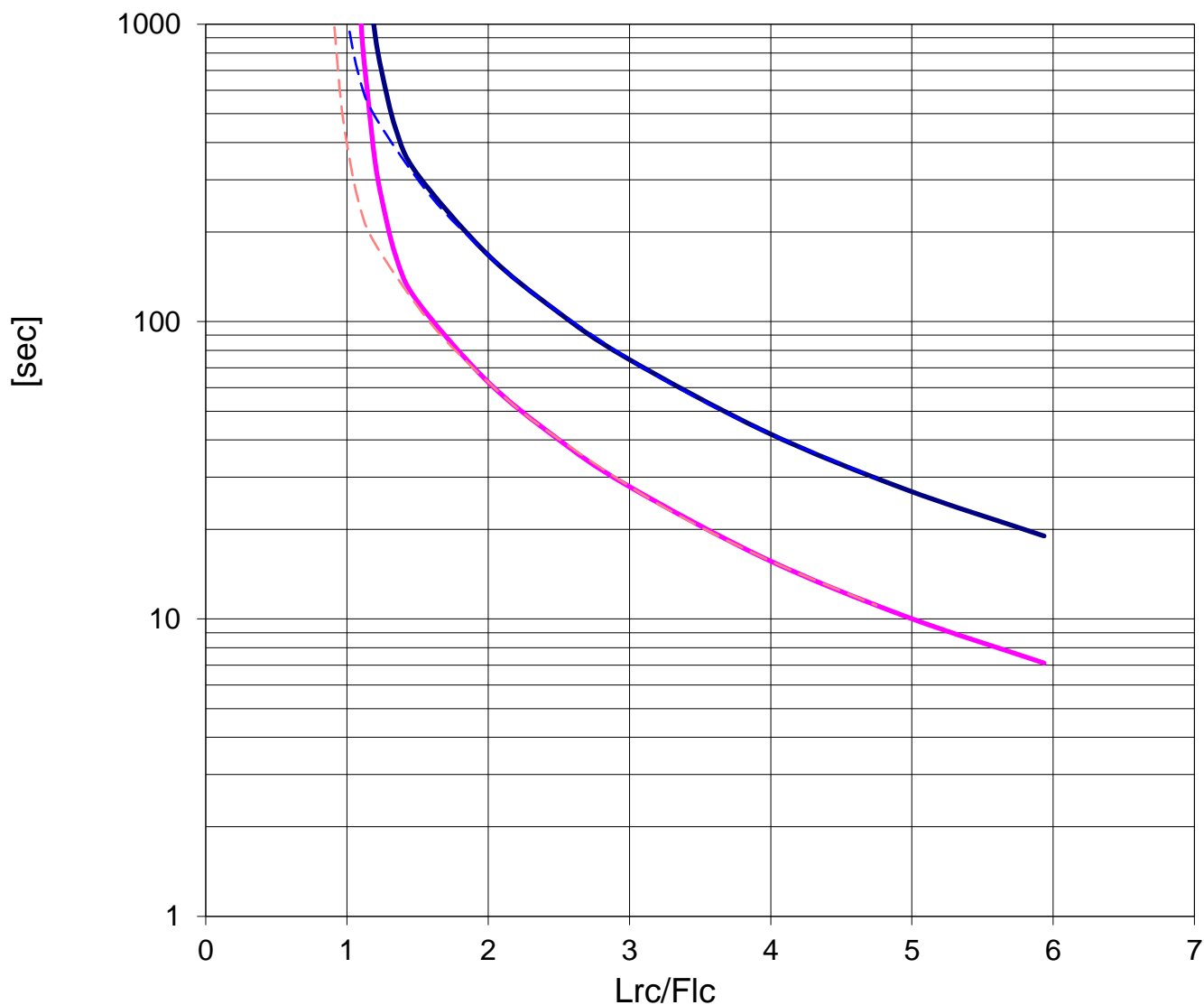
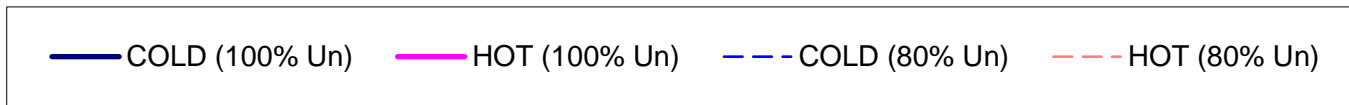

Valori calcolati - Data obtained by calculation method