

PRODUCT INFORMATION PACKET

rotor nl®

Model No: 6RN200L02E35U461041

Catalog No: 6RN200L02E35U46@1041

37.00 kW General Purpose Low Voltage IEC Motor IE3, 3 phase, 3000 rpm, D400/Y690V 50Hz,
200L Frame B3, IC411

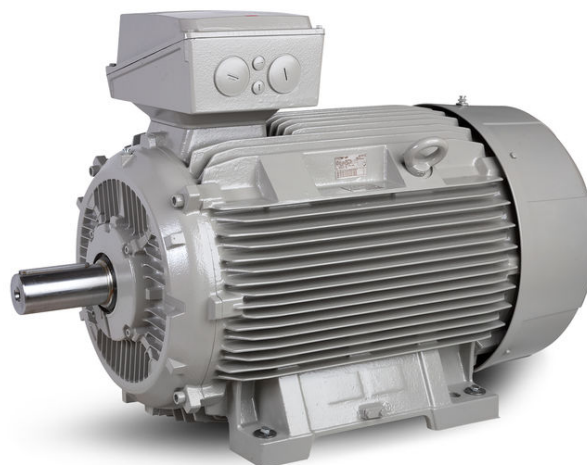

Regal and Rotor nl are trademarks of Regal Rexnord Corporation or one of its affiliated companies.
©2023 Regal Rexnord Corporation, All Rights Reserved. MC017097E

RegalRexnord



Nameplate Specifications

Output HP	50 Hp	Output KW	37.0 kW
Frequency	50 Hz	Voltage	D400/Y690 V
Current	64.97 A	Speed	2955 rpm
Service Factor	1	Phase	3
Efficiency	93.7 %	Power Factor	0.88
Duty	S1	Insulation Class	F
Frame	200L	Enclosure	Totally Enclosed Fan Cooled
Thermal Protection	No Protection	Ambient Temperature	40 °C
Drive End Bearing Size	6312-2Z/C3WT (-40°C/+160°C)	Opp Drive End Bearing Size	6312-2Z/C3WT (-40°C/+160°C)
UL	No	CSA	Optional
CE	Yes	IP Code	IP55
Number of Speeds	1	Efficiency Class	IE3

Technical Specifications

Electrical Type	Squirrel Cage	Starting Method	Direct On Line
Poles	2	Rotation	Clockwise Shaft End
Mounting	B3	Motor Orientation	Any
Frame Material	Cast iron	Shaft Type	Keyed
Shaft Diameter	55 mm	Shaft Extension	110 mm
Outline Drawing	6RN200L02E35U461041		

This is an uncontrolled document once printed or downloaded and is subject to change without notice. Date Created:01/19/2023

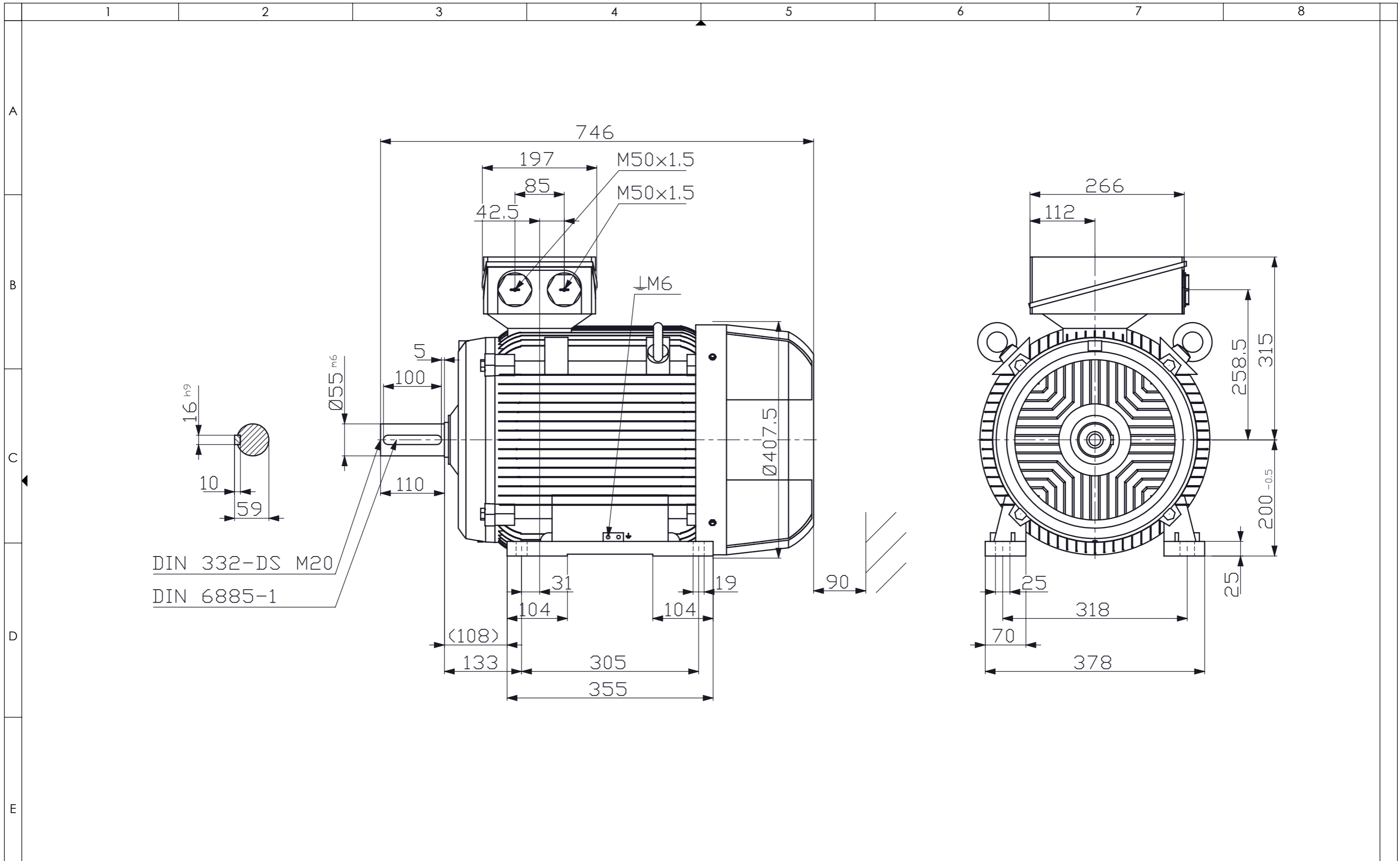

REVISIONS				
ZONE	REV.	DESCRIPTION	DATE	APPROVED

REGAL

rotor

Mors 2, P.O.box 45
7150 AA Eibergen nl
Tel:+31(0)545 464640
E-mail:info@rotor.nl

MOTORTYPE: 6RN200L02E35
MOUNTING: IM1041
PROTECTION:
COOLING: IC411
REMARKS:
DIMENSIONS: MM SCALE: 1:6

TITLE: Outline drawing
SPECIAL:
ART. NR.:
REVISION:
PAPER SIZE: A3 PAGE 1 OF 1

DRAWN:
CHECKED:
COMPLETE OR PARTIAL
COPYING OR USE OF
SPECIFICATIONS IS
NOT ALLOWED WITHOUT
OUR PERMISSION.
SUBJECT TO ALTERATIONS

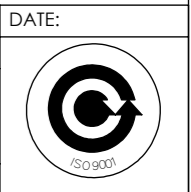

Datasheet



Mors 1-5, 7151 MX Eibergen NL
 www.rotor.nl tel.: +31 545 464640
 sales@rotor.nl tel.: +31 545 464646

Model No. 2-Pole cage motor 6RN 200L 37kW D400V 50Hz IM1041

U (V)	Δ / Y Conn	f [Hz]	P		I [A]	n [RPM]	T [Nm]	IE Class	% EFF at __ load			PF at __load			I _A /I _N [pu]	T _A /T _N [pu]	T _R /T _N [pu]
			[kW]	[hp]					FL	3/4FL	1/2FL	FL	3/4FL	1/2FL			
400	D	50	37	49,6	64,9	2955	119	IE3	93,9	94,1	93,7	0,88	0,85	0,79	7,00	2,39	3,18
690	Y		37,5														
460	D	60	41,5	55,63	63,2	3550	111	IE3	93,9	93,9	93,1	0,89	0,86	0,79	7,02	2,50	3,20

Motor type	6RN200L02E35
Enclosure	Totally Enclosed Fan Cooling
Frame Material	Cast iron
Frame size	200L
Duty	S1
Voltage	400 V
Frequency	50 Hz
Power output	37 kW
Insulation class	F
Ambient temperature	-20 till 40 °C
Temperature rise	temp.rise acc. B (80K)
Temperature rise winding	65 K
Temperature rise surface	25 K
Altitude above sea level	1000 mtr
Hazardous area classification	Safe area

Rotor type	Cage motor
Bearing type	6312-2Z/C3WT

Type of grease	Unirex N3
----------------	------------------

Phase resistance at 20°C	0,1399 Ohm
Country of origin	CZ

Voltage/Freq	Locked rotor Torque [nom] [%]	Starting current [% nom]	Pull-up Torque [% nom]	Breakdown Torque [% nom]	No-load Current [A]
@ D 400V 50Hz	239%	701%	210%	318%	20 A
@ D 460V 60Hz	250%	702%	210%	320%	18,5 A

NOTE

All performance values at rated voltage and frequency.
 All performance parameters are subjected to standard tolerance as per IEC 60034-1
 Voltage, Frequency are as per IEC60034-1
 Technical data are subject to change. There may be discrepancies between calculated and name plate values.

Efficiency	Europe	Global IEC
Standards	EN-IEC: 60034-30	IEC: 60034-30

This is an uncontrolled copy, data can be changed anytime.

Degree of protection	IP55
Mounting type	IM1041
Cooling method	IC411
Motor weight - approx.	249 kg
Gross weight - approx.	260 kg
Motor inertia	0,1600 kgm²
Vibration level	according IEC60034-14
Noise level (pressure) acc 60034-9	67 dB(A)

Direction of rotation	cw / ccw
-----------------------	-----------------

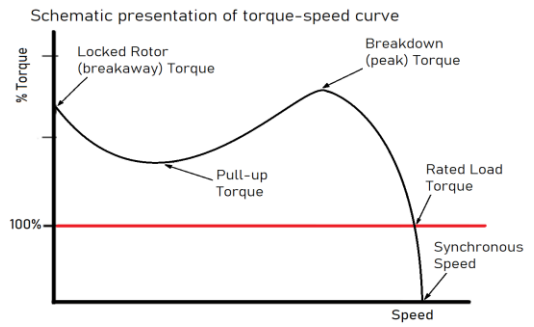

6RN200L02E35 2-pole 37,00kW D/Y 400/690V 50Hz S1 IC411 IE3



Torque versus Speed curve with variable frequency drive

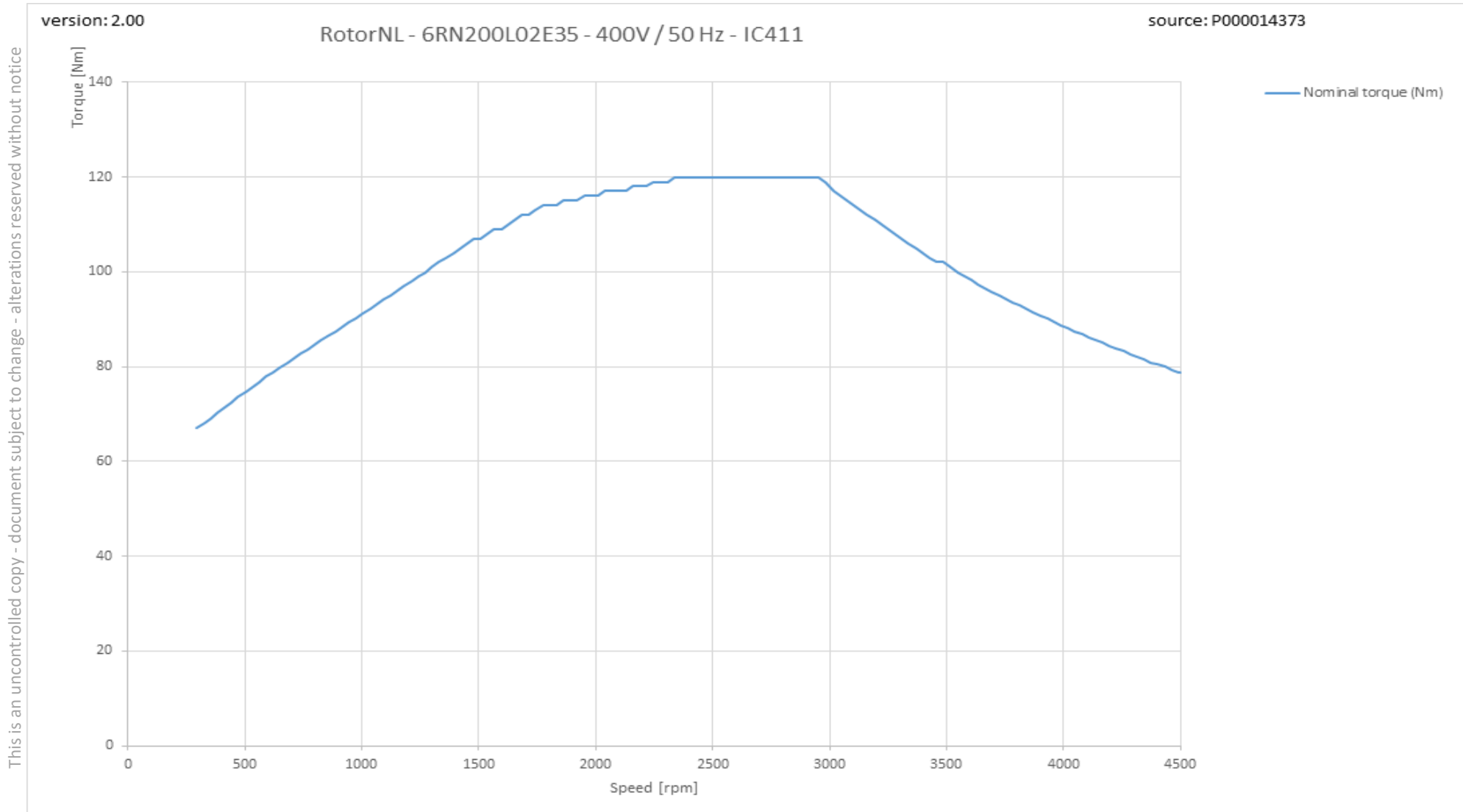

This is an uncontrolled copy - document subject to change - alterations reserved without notice

Therm_VSD graph

This is an uncontrolled copy - document subject to change - alterations reserved without notice

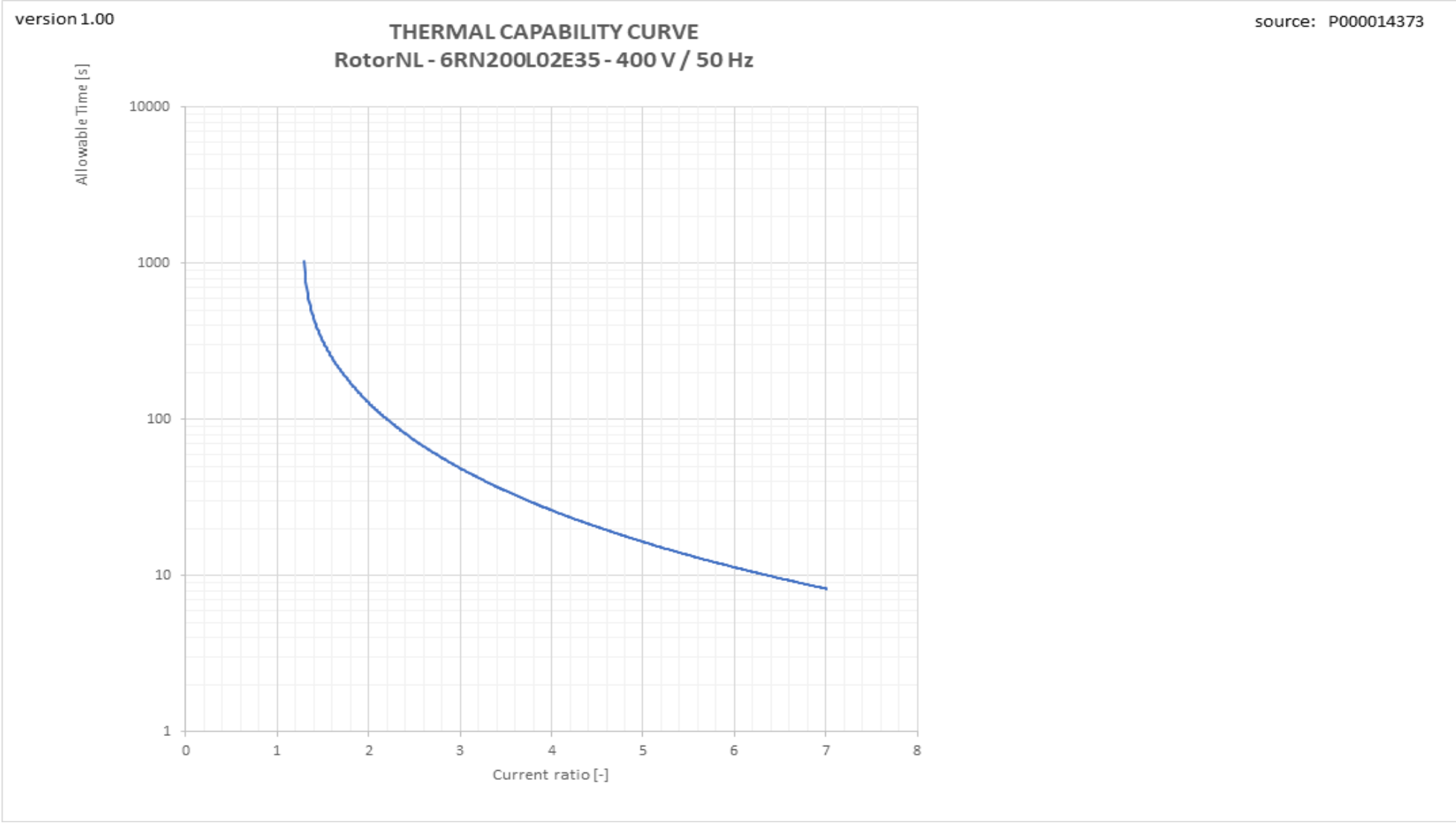

Tn graph

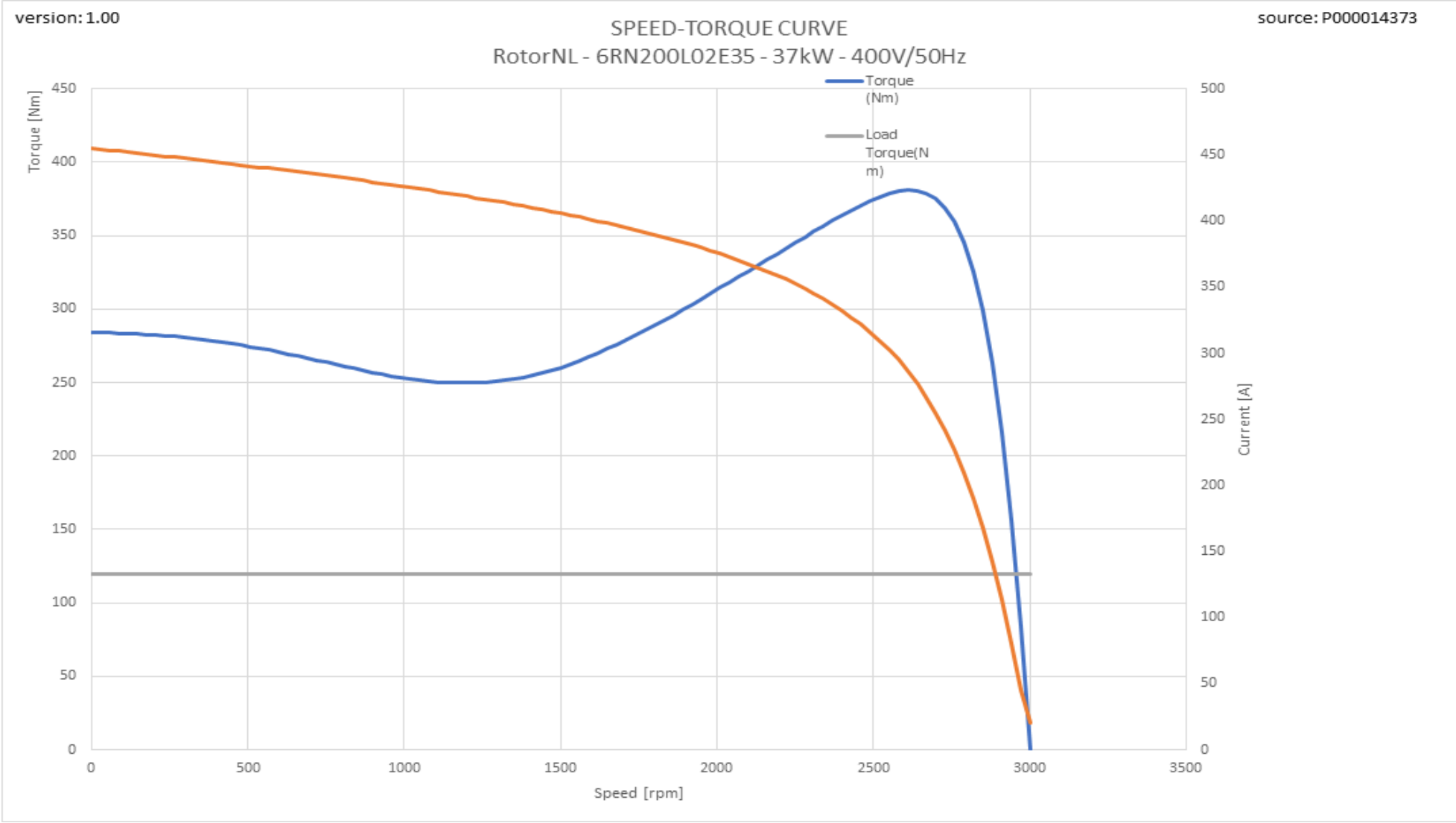

This is an uncontrolled copy - document subject to change - alterations reserved without notice