

PRODUCT INFORMATION PACKET

marathon®
Motors

Model No: 324TTFC6026

Catalog No: GT1034A

Globetrotter® General Purpose Motor, 40 & 30 HP, 3 Ph, 60 & 50 Hz, 230/460 & 190/380 V,
1800 & 1500 RPM, 324T Frame, TEFC



Regal and Marathon are trademarks of Regal Rexnord Corporation or one of its affiliated companies.

©2024 Regal Rexnord Corporation, All Rights Reserved. MC017097E

RegalRexnord



Nameplate Specifications

Phase	3	Output HP	40 & 30 Hp
Output KW	30.0 & 22.4 kW	Voltage	230/460 & 190/380 V
Speed	1782 & 1485 rpm	Service Factor	1.15 & 1.15
Frame	324T	Enclosure	Totally Enclosed Fan Cooled
Thermal Protection	No Protection	Efficiency	94.1 & 94.2 %
Ambient Temperature	40 °C	Frequency	60 & 50 Hz
Current	95/47.5 & 87/43.5 A	Power Factor	84
Duty	Continuous	Insulation Class	F
Design Code	B	KVA Code	G
Drive End Bearing Size	6312	Opp Drive End Bearing Size	6212
UL	Listed	CSA	Y
CE	Y	IP Code	55
Number of Speeds	1	Hazardous Location	DIVISION 2 T2B

Technical Specifications

Electrical Type	Squirrel Cage Inverter Rated	Starting Method	Part Wdg Start Low Volt Only & Wye Start Delta Run Or Inverter
Poles	4	Rotation	Reversible
Resistance Main	.18 Ohms	Mounting	Rigid Base
Motor Orientation	Horizontal	Drive End Bearing	Ball
Opp Drive End Bearing	Ball	Frame Material	Cast Iron
Shaft Type	T	Overall Length	29.69 in
Shaft Diameter	2.125 in	Shaft Extension	5.25 in
Assembly/Box Mounting	F1/F2 CAPABLE	Inverter Load	CONSTANT 10:1/VARIABLE 20:1
Outline Drawing	SS312782-100	Connection Drawing	EE7358

OUTLINE

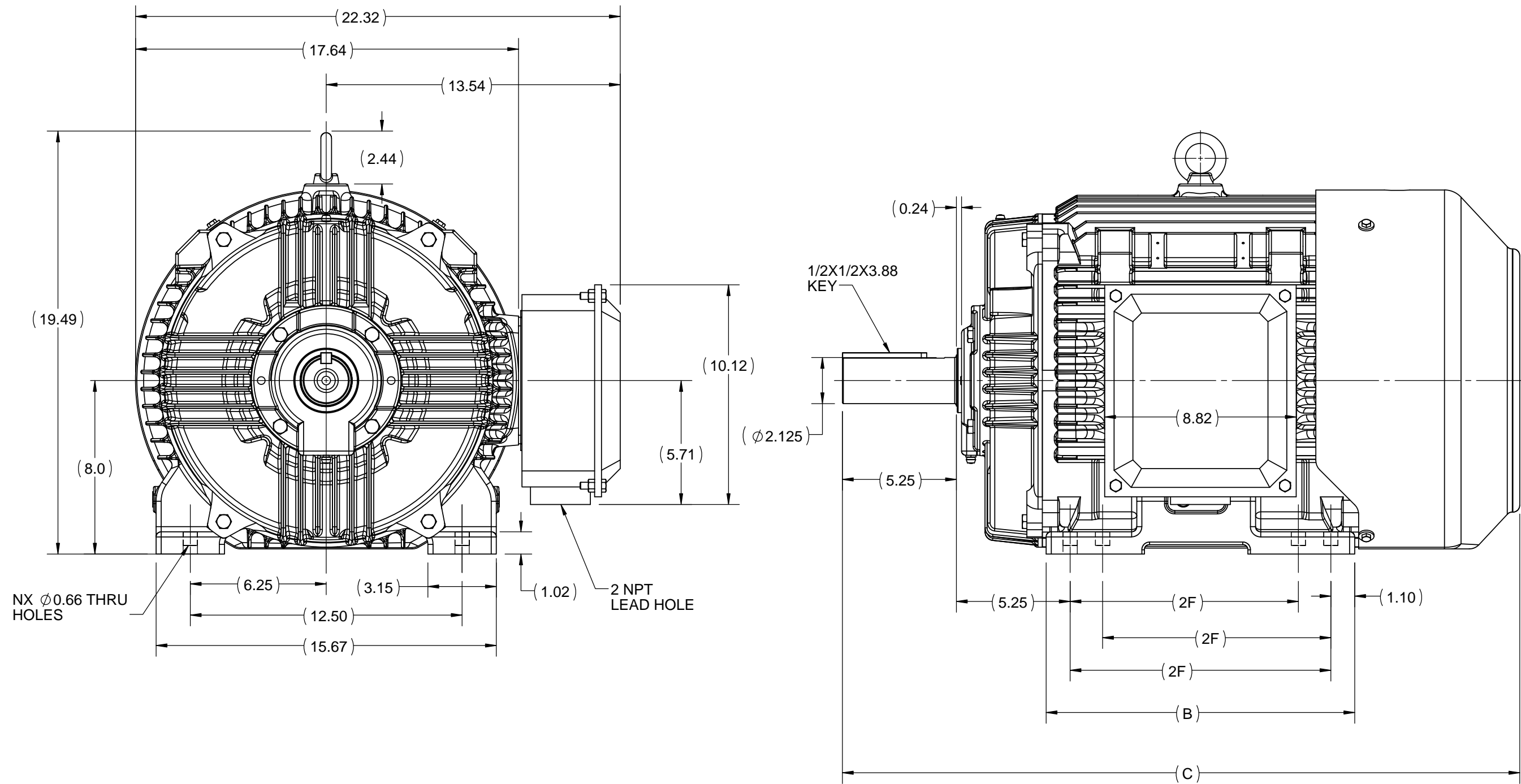

DRAWING REVISION A	REVISION BY NIV	DATE 30/01/2017
ECO ECO-0116959	APPROVED BY SBD	DATE 30/01/2017
ECO DESCRIPTION NEW OUTLINE RELEASE COPYRIGHT REGAL BELOIT AMERICA, INC. ALL RIGHTS RESERVED. PROPRIETARY AND CONFIDENTIAL INFORMATION - THIS DOCUMENT IS THE PROPERTY OF REGAL BELOIT AMERICA, INC. ("OWNER") AND CONTAINS OWNER'S PROPRIETARY INFORMATION. ANY PERSON, CORPORATION OR OTHER FIRM RECEIVING IT IS DEEMED, BY RECEIVING IT, TO AGREE THAT IT, AND/OR ANY PART OF IT, SHALL NOT BE DISCLOSED TO ANY PERSON, CORPORATION OR OTHER ENTITY, DUPLICATED, AND/OR USED, EXCEPT AS EXPRESSLY APPROVED IN WRITING IN ADVANCE BY OWNER. THIS DOCUMENT SHALL BE RETURNED TO OWNER UPON REQUEST. IT MAY BE SUBJECT TO CERTAIN RESTRICTIONS UNDER APPLICABLE EXPORT CONTROL LAWS AND REGULATIONS.		

DRAWN BY NIV	REGAL ™ Regal Beloit America, Inc.
DATE 27/12/2016	
APPROVED BY SBD	DESCRIPTION OUTLINE 320T FR-TEFC
DATE 27/12/2016	MATERIAL
REFERENCE	PROCESS/FINISH
THIRD ANGLE PROJECTION	SIZE B
	DRAWING NUMBER SS312782F
	SHEET 1 OF 1

326T	14.21	31.19	12.0	8
324T	12.71	29.69	10.5	4
FRAME	B	C	2F	N

HIGH VOLTAGE

WYE START

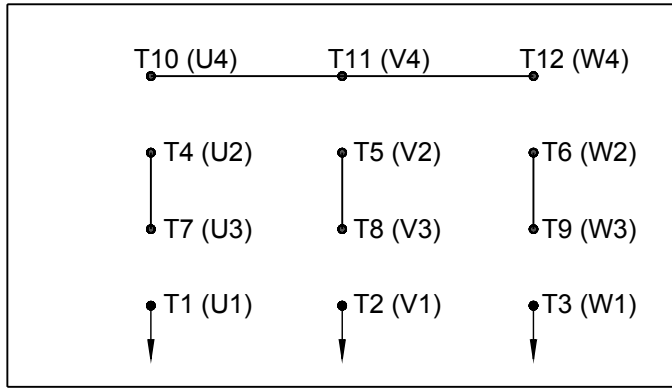

DELTA RUN

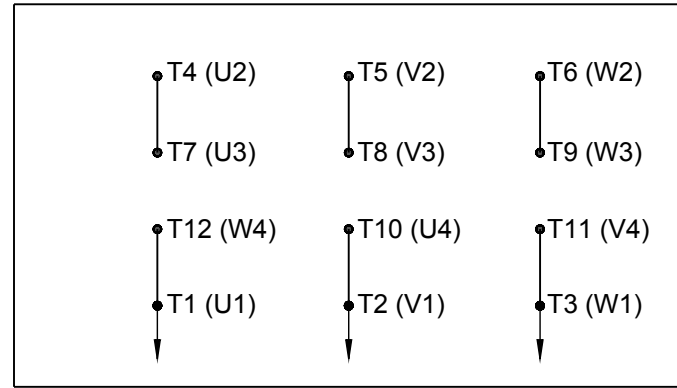

WYE START

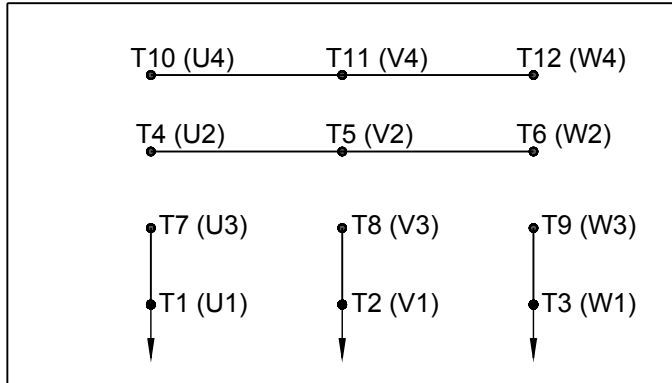

LOW VOLTAGE

DELTA RUN

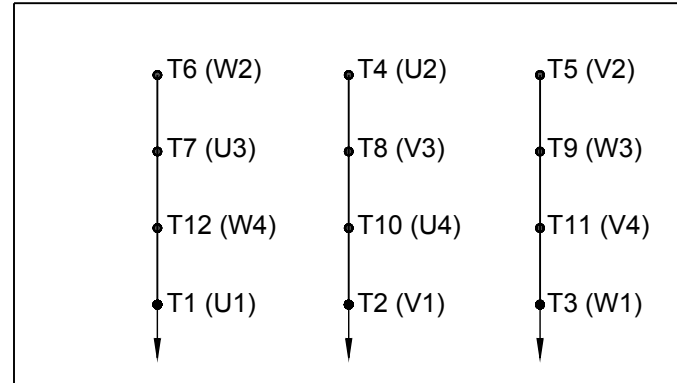

4/2 CKTY \triangle

DRAWING REVISION D	REVISION BY JWO	DATE 01-26-2016
ECO ECO-0092547	APPROVED BY TB	DATE 01-26-2016

ECO DESCRIPTION
ADDED IEC MARKINGS

COPYRIGHT REGAL BELOIT AMERICA, INC. ALL RIGHTS RESERVED. PROPRIETARY AND CONFIDENTIAL INFORMATION - THIS DOCUMENT IS THE PROPERTY OF REGAL BELOIT AMERICA, INC. ("OWNER") AND CONTAINS OWNER'S PROPRIETARY INFORMATION. ANY PERSON, CORPORATION OR OTHER FIRM RECEIVING IT IS DEEMED, BY RECEIVING IT, TO AGREE THAT IT, AND/OR ANY PART OF IT, SHALL NOT BE DISCLOSED TO ANY PERSON, CORPORATION OR OTHER ENTITY, DUPLICATED, AND/OR USED, EXCEPT AS EXPRESSLY APPROVED IN WRITING IN ADVANCE BY OWNER. THIS DOCUMENT SHALL BE RETURNED TO OWNER UPON REQUEST. IT MAY BE SUBJECT TO CERTAIN RESTRICTIONS UNDER APPLICABLE EXPORT CONTROL LAWS AND REGULATIONS.

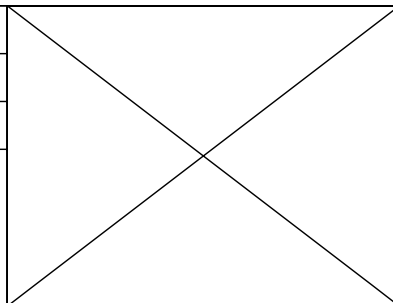

DRAWN BY BLR	Regal Beloit America, Inc.		
DATE 03-09-1998			
APPROVED BY GK	DESCRIPTION CONN DIAGRAM-EXTERNAL 12 LEAD - DUAL VOLT. - WYE START - DELTA RUN		
DATE 03-23-1998			
REFERENCE	MATERIAL	PROCESS/FINISH	
THIRD ANGLE PROJECTION	SIZE A	DRAWING NUMBER EE7358	SHEET 1 OF 1

DRAWING REVISION D		REVISION BY JWO		DATE 01-26-2016	
ECO ECO-0092547		APPROVED BY TB		DATE 01-26-2016	
ECO DESCRIPTION ADDED IEC MARKINGS					
<small>COPYRIGHT REGAL BELOIT AMERICA, INC. ALL RIGHTS RESERVED. PROPRIETARY AND CONFIDENTIAL INFORMATION - THIS DOCUMENT IS THE PROPERTY OF REGAL BELOIT AMERICA, INC. ("OWNER") AND CONTAINS OWNER'S PROPRIETARY INFORMATION. ANY PERSON, CORPORATION OR OTHER FIRM RECEIVING IT IS DEEMED, BY RECEIVING IT, TO AGREE THAT IT, AND/OR ANY PART OF IT, SHALL NOT BE DISCLOSED TO ANY PERSON, CORPORATION OR OTHER ENTITY, DUPLICATED, AND/OR USED, EXCEPT AS EXPRESSLY APPROVED IN WRITING IN ADVANCE BY OWNER. THIS DOCUMENT SHALL BE RETURNED TO OWNER UPON REQUEST. IT MAY BE SUBJECT TO CERTAIN RESTRICTIONS UNDER APPLICABLE EXPORT CONTROL LAWS AND REGULATIONS.</small>					
DRAWN BY BLR		Regal Beloit America, Inc.			
DATE 03-09-1998					
APPROVED BY GK		DESCRIPTION CONN DIAGRAM-EXTERNAL 12 LEAD - DUAL VOLT. - WYE START - DELTA RUN			
DATE 03-23-1998					
REFERENCE		MATERIAL		PROCESS/FINISH	
THIRD ANGLE PROJECTION		SIZE A		DRAWING NUMBER EE7358	
				SHEET 1 OF 1	



**P.O. BOX 8003
WAUSAU, WI 54401-8003
PH. 715-675-3311**

CERTIFICATION DATA SHEET

CUSTOMER:

**CUSTOMER
PO#:**

ORDER #:

MODEL #: 324TTFC6026 BB

CONN. DIAGRAM: EE7308AA

**CUSTOMER PART
#:**

OUTLINE: SS312782-324T

MOUNTING: F1/F2 CAPABLE

WINDING #: HE32004007 2

TYPICAL MOTOR PERFORMANCE DATA

HP	kW	SYNC. RPM	F.L. RPM	FRAME	ENCLOSURE	KVA CODE	DESIGN
40&30	30.0&22.4	1800	1782&1485	324T	TEFC	G	B

PH	Hz	VOLTS	AMPS	START TYPE	DUTY	INSL	S.F.	AMB°C
3	60/50	230/460&190/380	95/47.5&86/43	Y START D RUN OR INV	CONTINUOUS	F7	1.15/1.15	40

FULL LOAD EFF:	94.1&93.9	3/4 LOAD EFF:	94.1	1/2 LOAD EFF:	93.6	GTD. EFF		ELEC. TYPE	
FULL LOAD PF:	84&84	3/4 LOAD PF:	81	1/2 LOAD PF:	72.5	93.6		SQ CAGE INV RATED	

F.L. TORQUE	LOCKED ROTOR AMPS	L.R. TORQUE	B.D. TORQUE	F.L. RISE°C
118 LB-FT	580 / 290	212 LB-FT 180 %	313 LB-FT 265 %	55

SOUND PRESSURE @ 3 FT.	SOUND POWER	ROTOR WK^2	MAX. WK^2	SAFE STALL TIME	STARTS / HOUR	APPROX. MOTOR WGT
60 dBA	70 dBA	11.2 LB-FT^2	- LB-FT^2	20 SEC.	2	625 LBS.

***** SUPPLEMENTAL INFORMATION *****

DE BRACKET TYPE	ODE BRACKET TYPE	MOUNT TYPE	ORIENTATION	SEVERE DUTY	HAZARDOUS LOCATION	DRIP COVER	SCREENS	PAINT
STANDARD	STANDARD	RIGID	HORIZONTAL	FALSE	DIVISION 2 T2B	FALSE	NONE	BLUE (ENAMEL)

BEARINGS		GREASE	SHAFT TYPE	SPECIAL DE	SPECIAL ODE	SHAFT MATERIAL	FRAME MATERIAL
DE	ODE						
BALL	BALL	POLYREX EM	T	NONE	NONE	1045 HOT ROLLED (C-204)	CAST IRON
6312	6212						

THERMO-PROTECTORS				THERMISTORS	CONTROL	SPACE HEATERS
THERMOSTATS	PROTECTORS	WDG RTDs	BRG RTDs			
NONE	NOT	NONE	NONE	NONE	FALSE	NONE VOLTS

*
N
O
T
E
S
*

INVERTER TORQUE: CONSTANT 10:1/VARIABLE 10:1
INV. HP SPEED RANGE: NONE
ENCODER: NONE NONE NONE NONE NONE PPR
BRAKE: NONE NONE NONE P/N NONE NONE NONE NONE FT-LB NONE V NONE Hz

PREPARED BY: Anusha Muthyala
DATE: 09/24/2019 01:20:44 AM
FORM 3531 REV.3 02/07/99
** Subject to change without notice.

Data Sheet

Date: 12/14/2018
 Customer: _____
 Attention: _____
 Submitted by: FAREEDA DUDEKULA



324TTFCD6026

Submittal

Data @ 460 V

Motor Load Data

Load	0%	25%	50%	75%	100%	115%	125%	LR
Current (Amps)	17.5	20.5	27.8	37.0	47.5	54.2	59.0	290
Torque (ft-lb)	0.00	29.3	58.5	88.3	118	136	149	212
RPM	1800	1795	1790	1788	1782	1,780	1778	0
Efficiency (%)		91.0	93.6	94.1	94.1	93.6	93.0	
P.F. (%)	5.0	50.5	72.5	81.0	84.0	85.5	85.5	32.0

Motor Speed Data

	LR	Pull-Up	BD	Rated	Idle
Speed (RPM)	0	900	1710	1782	1800
Current (Amps)	290	230	170	47.5	17.5
Torque (ft-lb)	212	180	313	118	0.00

Information Block

HP	40.0			
Sync. RPM	1800			
Frame	324			
Enclosure	TEFC			
Construction	TFC			
Voltage	230/460#190/380 V			
Frequency	60 Hz			
Design	B			
LR Code letter	G			
Service Factor	1.15			
Temp Rise @ FL	55 °C			
Duty	CONT			
Ambient	40 °C			
Elevation	1,000 feet			
Rotor/Shaft wk ²	11.2 Lb-Ft ²			
Ref Wdg	HE32004007 NONE			
Sound Pressure @ 1M	60 dBA			
VFD Rating	VARIABLE 10:1			
Outline Dwg	SS312782			
Conn. Diag	EE7308AA			
Additional Specifications:				
0				
0				
EQUIV CKT (OHMS / PHASE)				
R1	R2	X1	X2	Xm
0.1130	0.0610	0.4680	0.8300	15.3850

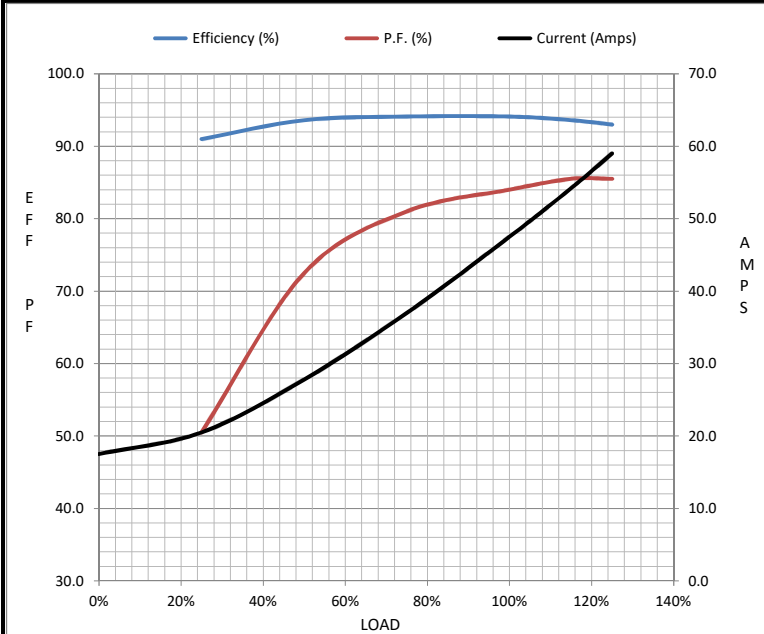

Speed -Torque Curve

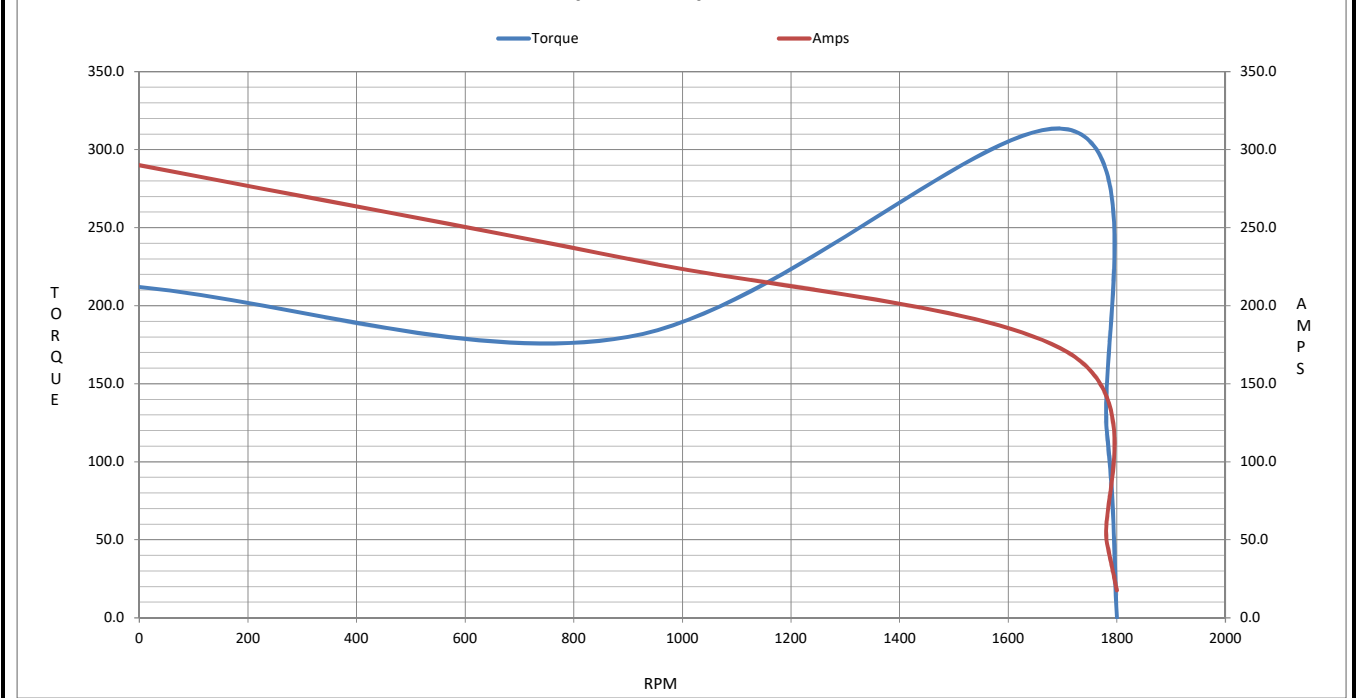

EC Declaration of Conformity

The undersigned representing
the manufacturer:

Regal Beloit America
100 East Randolph St.
Wausau, WI 54401

and the authorized representative
established within the Community:

Marathon Electric UK
6F Thistleton Road Ind. Estate
Market Overton
Oakham, Rutland LE15 7PP UK

are committed to providing customers with products that comply with applicable regulations and international protocols to which they are subject, including the requirements of the European Parliament Directive on the Harmonization of the laws relating to electrical equipment designed for use within certain voltage limits (2014/35/EU).

Regal Beloit America declares that the following product(s), to which this declaration relates, are in conformity with the relevant sections of the EC standards listed below.

This statement supersedes any statements previously issued pertaining to the product(s) listed below and is subject to change without notice.

Model No : 324TTFCD6026

(Model No. may contain prefix and/or suffix characters)

Catalog No : GT1034A

Rework No : N/A

Directives :

Low Voltage Directive 2014/35/EU

Harmonized Standards Used :

EN 60034-1: 2010 (IEC 60034-1: 2010)

EN 60034-5: 2001/A1:2007 (IEC 60034-5: 2000/A1:2006)

Authorized Representative:



Michael A. Logsdon
Vice President, Technology

Authorized Representative in the Community:



Julian Clark
Marketing Engineer

Created on 09/01/2022

CE 22