

PRODUCT INFORMATION PACKET

Model No: 213TBFW7026

Catalog No: I216

General Purpose Motor, 5 HP, 1 Ph, 60 Hz, 208-230 V, 1800 RPM, 213T Frame, TEFC



Regal and Marathon are trademarks of Regal Rexnord Corporation or one of its affiliated companies.

©2023 Regal Rexnord Corporation, All Rights Reserved. MC017097E

Nameplate Specifications

Phase	1	Output HP	5 Hp
Output KW	3.7 kW	Voltage	208-230 V
Speed	1749 rpm	Service Factor	1
Frame	213T	Enclosure	Totally Enclosed Fan Cooled
Thermal Protection	No Protection	Efficiency	82.5 %
Ambient Temperature	40 °C	Frequency	60 Hz
Current	24.5-22.0-22.0 A	Power Factor	89
Duty	Continuous	Insulation Class	B
Design Code	L	KVA Code	G
Drive End Bearing Size	6307	Opp Drive End Bearing Size	6206
UL	Recognized	CSA	Y
CE	Y	IP Code	43
Number of Speeds	1		

Technical Specifications

Electrical Type	Capacitor Start Capacitor Run	Starting Method	Across The Line
Poles	4	Rotation	Selective Counterclockwise
Resistance Main	.358 Ohms	Mounting	Rigid Base
Motor Orientation	Horizontal	Drive End Bearing	Ball
Opp Drive End Bearing	Ball	Frame Material	Rolled Steel
Shaft Type	T	Overall Length	18.73 in
Frame Length	9.65 in	Shaft Diameter	1.375 in
Shaft Extension	3.47 in	Assembly/Box Mounting	F1/F2 CAPABLE
Outline Drawing	037646-965	Connection Drawing	A-EE9048MF

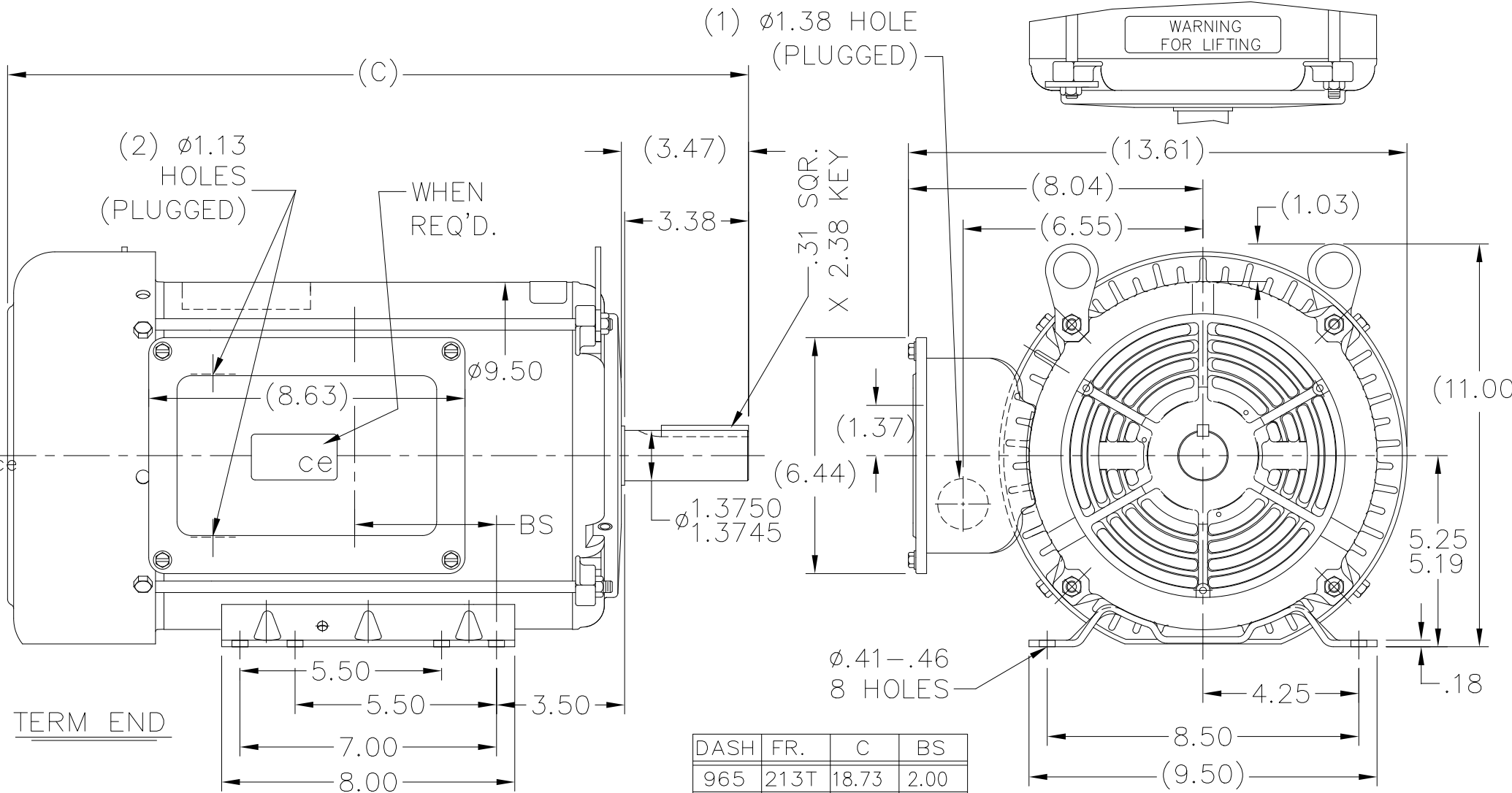

NOTES:
1. NAMEPLATE TO BE READ FROM C'BOX SIDE OF MOTOR.

		TOLERANCES UNLESS SPECIFIED			DRAWN GRB 11/14/08
		DEC.	INCHES		CHK SK 11/14/08
			.X	±.1	APPD
			.XX	±.03	SCALE 1=4
02	COND.BOX LEAD POSITION UPDATED—CR—0017070	SR 10/5/2023	.XXX	±.005	REF SS86677
01	ADD CE DECAL PER ISAAC 11—0604	LST 2/11/11	.XXXX	±.0005	FMF
NO.	REVISION	BY & DATE	CHK	ANG ±7'30"	PREV
THIS DRAWING IN DESIGN AND DETAIL IS OUR PROPERTY AND MUST NOT BE USED EXCEPT IN CONNECTION WITH OUR WORK ALL RIGHTS OF DESIGN AND INVENTION ARE RESERVED THIS IS AN ELECTRONICALLY GENERATED DOCUMENT — DO NOT SCALE THIS PRINT			RFP	CAD FILE 037646	SIZE A
			DIST LB		DRAWING NO. 037646
					PAGE 1 OF 1
					REV. 02

C.W. ROTATION

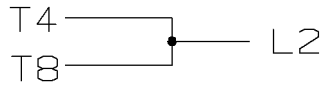
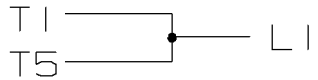

C.C.W. ROTATION

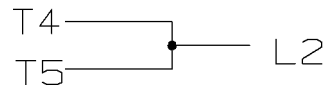
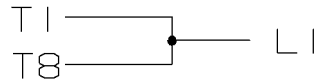

SINGLE VOLTAGE
CAPACITOR START
CAPACITOR RUN
REVERSIBLE

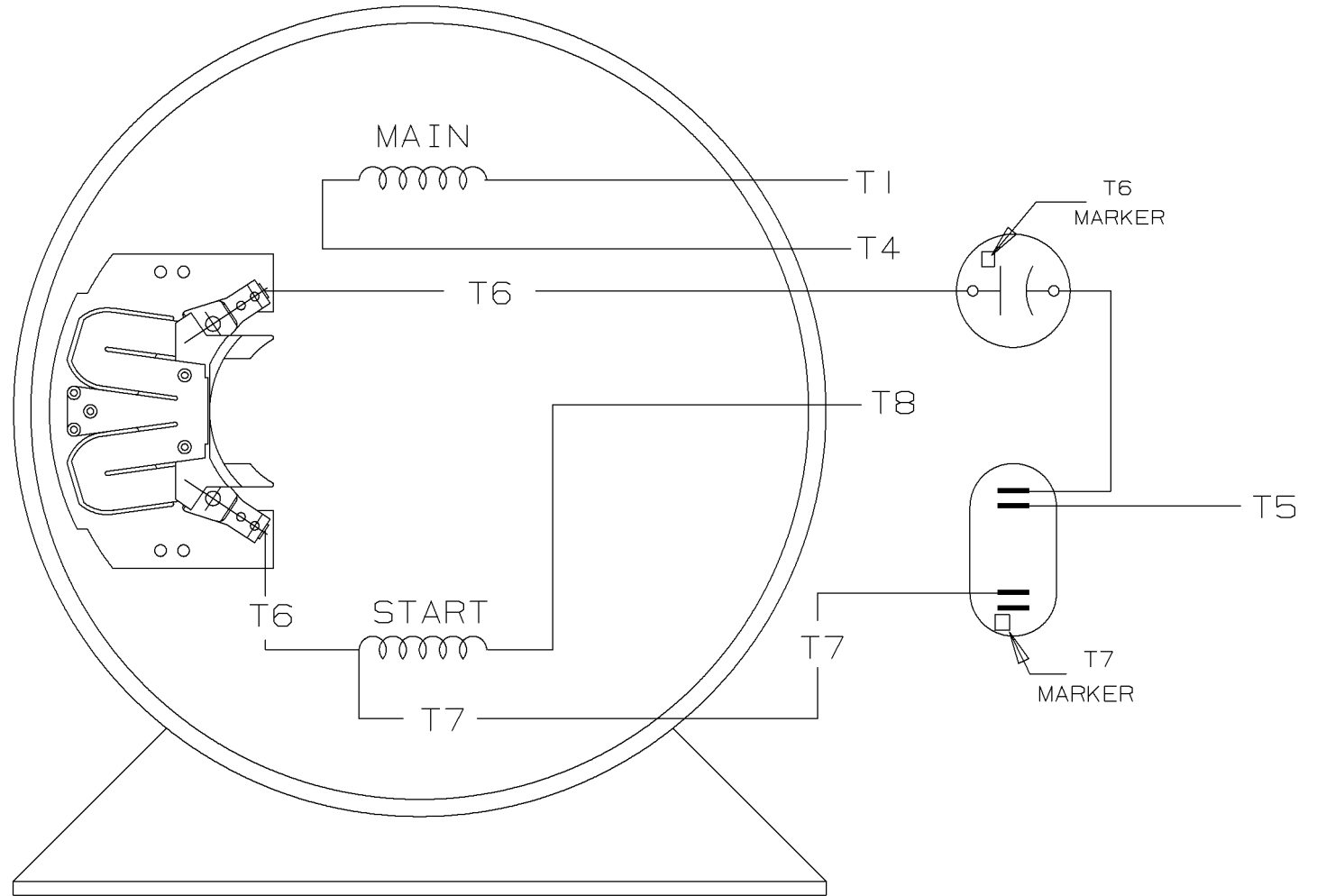

VIEW OF TERMINAL END

				✓ MAX. SURFACE ROUGHNESS UNLESS NOTED OTHERWISE	UNLESS OTHERWISE SPECIFIED DIMENSIONS ARE IN INCHES TOL. ON XX± XXX±.005 XXXX±.0005 ANGLES±		
				MATL SPEC	180 - 210 SWITCH	DRAWN BY	GK 11-01-1986
				FINISH	MARATHON ELECTRIC	CHKD BY	ML 11-01-1986
I	11-04-1986	NEW DRAWING	CN 7664C	GK	REFERENCE DRW.	WAUSAU, WISCONSIN 54401	APPD BY FG 11-04-1986
REV	DATE	CHANGE	NAME	PART NAME CONNECTION DIAGRAM			DRWG NO A-EE9048MF

SHOP BOOK

PURCHASED

DISTRIBUTION - WA - LB - WP - LM - BR

CADD FILE NO.

EE9048MF

CERTIFICATION DATA SHEET

Model#: 213TBFW7026 AB WINDING#: BK104123 NONE 2
 CONN. DIAGRAM: A-EE9048MF ASSEMBLY: F1/F2 CAPABLE
 OUTLINE: 037646-965

TYPICAL MOTOR PERFORMANCE DATA

HP	KW	SYNC. RPM	F.L. RPM	FRAME	ENCLOSURE	KVA CODE	DESIGN
5	3.7	1800	1749	213T	TEFC	G	L

PH	Hz	VOLTS	FL AMPS	START TYPE	DUTY	INSL	S.F	AMB°C	ELEVATION
1	60	208-230	24.5-22	ACROSS THE LINE	CONTINUOUS	B4	1.0	40	3300

FULL LOAD EFF: 82.5	3/4 LOAD EFF: 0	1/2 LOAD EFF: 0	GTD. EFF	ELEC. TYPE	NO LOAD AMPS
FULL LOAD PF: 89	3/4 LOAD PF: 0	1/2 LOAD PF: 0	80	CAP START CAP RUN	6.7

F.L. TORQUE	LOCKED ROTOR AMPS	L.R. TORQUE	B.D. TORQUE	F.L. RISE°C
15 LB-FT	130	31.4 LB-FT -	34.9 LB-FT -	70

SOUND PRESSURE @ 3 FT.	SOUND POWER	ROTOR WK^2	MAX. WK^2	SAFE STALL TIME	STARTS /HOUR	APPROX. MOTOR WGT
0 dBA	10 dBA	- LB-FT^2	0 LB-FT^2	0 SEC.	0	- LBS.

*** SUPPLEMENTAL INFORMATION ***

DE BRACKET TYPE	ODE BRACKET TYPE	MOUNT TYPE	ORIENTATION	SEVERE DUTY	HAZARDOUS LOCATION	DRIP COVER	SCREENS	PAINT
STANDARD	STANDARD	RIGID	HORIZONTAL	FALSE	NONE	FALSE	NONE	BLUE (ENAMEL)

BEARINGS		GREASE	SHAFT TYPE	SPECIAL DE	SPECIAL ODE	SHAFT MATERIAL	FRAME MATERIAL
DE	OPE						
BALL	BALL	POLYREX EM	T	NONE	NONE	AISI 1045 (C-240)	ROLLED STEEL
6307	6206						

THERMO-PROTECTORS				THERMISTORS	CONTROL	SPACE /n HEATERS
THERMOSTATS	PROTECTORS	WDG RTDs	BRG RTDs			
NONE	NOT	NONE	NONE	NONE	FALSE	NONE VOLTS

If Inverter equals NONE, contact factory for further information

*
N
O
T
E
S
*

INVERTER TORQUE: NONE
INV. HP SPEED RANGE: NONE
ENCODER: NONE
NONE NONE
NONE NONE PPR
BRAKE: NONE NONE
NONE P/N NONE
NONE NONE
- FT-LB NONE V NONE Hz

DATE: 06/22/2017 03:48:43 AM
 FORM 3531 REV.3 02/07/99
 ** Subject to change without notice.



MARATHON ELECTRIC CORPORATION
TYPICAL PERFORMANCE CURVE for AC MOTOR

Customer

Curve at

230
60
5

Volts
HZ
HP

HP 5.00

PHASE 1

Model No 213TBFW7026

VOLTS 208-230

Catalog No I216

HZ 60

RPM 1749

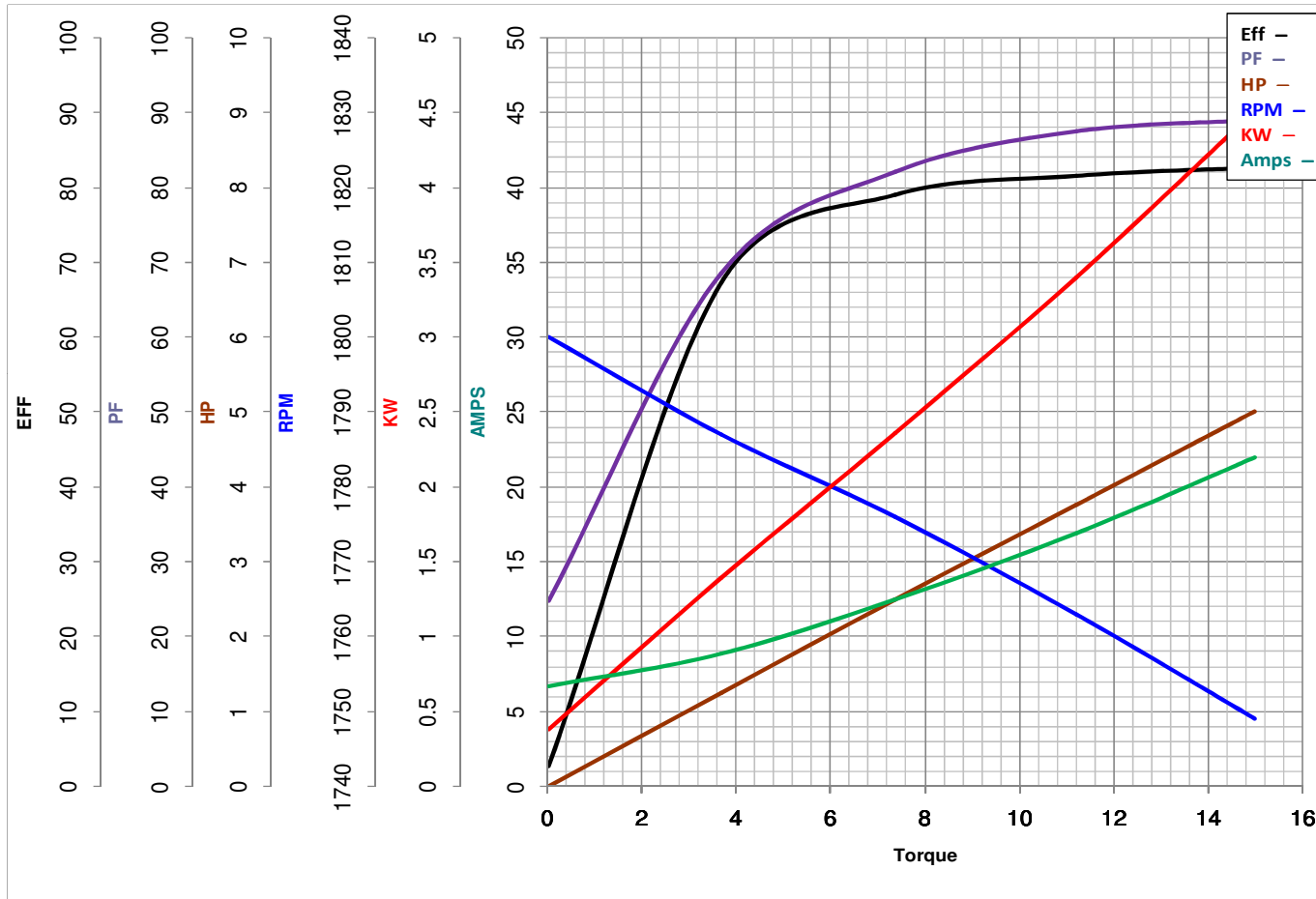

Torque in Lb.Ft

FL TORQUE 15 Lb.Ft
BD TORQUE 34.9 Lb.Ft
LR TORQUE 31.4 Lb.Ft

FL AMPS 24.5-22
PU TORQUE 31.0 Lb.Ft
LR AMPS 130

WINDING BK104123-2

Date 1/25/2019

EC Declaration of Conformity

The undersigned representing
the manufacturer:

Regal Beloit America
100 East Randolph St.
Wausau, WI 54401

and the authorized representative
established within the Community:

Marathon Electric UK
6F Thistleton Road Ind. Estate
Market Overton
Oakham, Rutland LE15 7PP UK

are committed to providing customers with products that comply with applicable regulations and international protocols to which they are subject, including the requirements of the European Parliament Directive on the Harmonization of the laws relating to electrical equipment designed for use within certain voltage limits (2014/35/EU).

Regal Beloit America declares that the following product(s), to which this declaration relates, are in conformity with the relevant sections of the EC standards listed below.

This statement supersedes any statements previously issued pertaining to the product(s) listed below and is subject to change without notice.

Model No : 213TBFW7026

(Model No. may contain prefix and/or suffix characters)

Catalog No : I216

Rework No : N/A

Directives :

Low Voltage Directive 2014/35/EU

Harmonized Standards Used :

EN 60034-1: 2010 (IEC 60034-1: 2010)

EN 60034-5: 2001/A1:2007 (IEC 60034-5: 2000/A1:2006)

Authorized Representative:

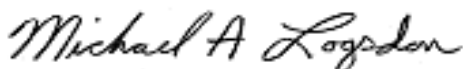

Michael A. Logsdon
Vice President, Technology

Authorized Representative in the Community:



Julian Clark
Marketing Engineer

Created on 09/01/2022

CE 22