

Installation, Operation, and Maintenance Instructions

NEMA 182T – 286T, IEC 112 -180 Permanent Magnet Motors Operated On Variable Frequency Drives (VFD)



www.leeson.com



www.marathonelectric.com

**INSTALLER: PLEASE LEAVE THIS MANUAL FOR THE OWNER'S USE
OWNER: READ AND SAVE THESE INSTRUCTIONS**

SAFETY INSTRUCTIONS

- ▲ This is the safety alert symbol. It is used to alert you to potential personal injury hazards. Obey all safety messages that follow this symbol to avoid possible injury or death.
- ▲ **WARNING:** Warning indicates a potentially hazardous situation which, if not avoided, could result in death or serious injury.
- ▲ **CAUTION:** Caution indicates a potentially hazardous situation which, if not avoided, may result in minor or moderate injury.
- ▲ **NOTICE:** Notice indicates a situation not related to personal injury which, if not avoided, may result in motor or equipment damage.

▲ Before installing, using, or servicing this product, carefully read and fully understand the instructions including all warnings, cautions, & safety notice statements. To reduce risk of personal injury, death and/or property damage, follow all instructions for proper motor installation, operation and maintenance.

Although you should read and follow these instructions, they are not intended as a complete listing of all details for installation, operation, and maintenance. If you have any questions concerning any of the procedures, or if you have a safety concern not covered by the instructions, STOP, and call the appropriate motor company listed on the motor nameplate. The phone number can be found on the web site listed above.

Table of Contents

1.0 SAFETY INFORMATION

- 1.1 Electrical Safety
- 1.2 Mechanical Safety
- 1.3 Environmental Safety

2.0 RECEIVING & INSPECTION

- 2.1 Initial Inspection
 - 2.1.1 Packing List & Inspect
 - 2.1.2 Turn Motor Shaft
 - 2.1.3 Check Nameplate
- 2.2 Handling
 - 2.2.1 Lifting Angle Limitations
- 2.3 Storage
 - 2.3.1 Bearing Lubrication
 - 2.3.2 Shaft Rotation
 - 2.3.3 Damp or Humid Storage Locations

3.0 INSTALLATION AND OPERATION

- 3.1 Location
 - 3.1.1 Selecting a Location
 - 3.1.2 Ambient Temperature Limits
 - 3.1.3 Construction Selection per Location
 - 3.1.3.1 Totally Enclosed
 - 3.1.3.2 Hazardous Locations Motors
- 3.2 Mounting Motor
 - 3.2.1 Rigid Base (Footed)
 - 3.2.2 Rigid Base Hole Selection -6 or 8 Hole Bases
 - 3.2.3 Vertical Mounting
- 3.3 Application Assembly to Motor
 - 3.3.1 General: Proper Alignment
 - 3.3.2 Direct Coupling
 - 3.3.3 Direct Connected
 - 3.3.3.1 Sheave Diameter Requirements
 - 3.3.3.2 Number of Belts
 - 3.3.3.3 Sheave Location
 - 3.3.3.4 Belt Tension
 - 3.3.4 Belted
 - 3.3.4.1 Sheave Diameter Requirements
 - 3.3.4.2 Number of Belts
 - 3.3.4.3 Sheave Location
 - 3.3.4.4 Belt Tension
- 3.3.5 Permanent Magnet Motor VFD Operation
 - 3.3.5.1 Overspeed Capability

- 3.3.5.2 Cable Lengths
- 3.3.5.3 VFD Grounding
- 3.3.5.4 Stray Voltage On Accessory Leads

3.3.6 Accessories

- 3.3.6.1 General
- 3.3.6.2 Brake Motors
- 3.3.6.3 Space Heaters
- 3.3.6.4 Thermal Protection
- 3.3.6.5 RTD Alarm & Trip Settings

3.3.7 Guards

3.4 Electrical Connections

- 3.4.1 Power Supply / Branch Circuit
 - 3.4.1.1 Fuses, Breakers, Overload Relays
 - 3.4.1.2 AC Power Supply Limits
- 3.4.2 Terminal Box
 - 3.4.2.1 Conduit opening
- 3.4.3 Lead Connections
- 3.4.4 Ground Connections
 - 3.4.4.1 Electrical Interference
- 3.4.5 Start Up
 - 3.4.5.1 Start Up – No Load Procedure
 - 3.4.5.2 Start Up – Load Connected Procedure

4.0 MAINTENANCE

4.1 General Inspection

- 4.1.1 Ventilation
- 4.1.2 Insulation
- 4.1.3 Electrical Connections
- 4.1.4 Seal Condition
- 4.1.5 Safety Labels

4.2 Lubrication and Bearings

- 4.2.1 Grease Type
- 4.2.2 Bearing Operating Temperature
- 4.2.3 Lubrication Interval
- 4.2.4 Lubrication Procedure
- 4.2.5 Lubrication Example

4.3 Trouble Shooting

- 4.3.1 General Trouble-Shooting Warnings

1.0 SAFETY INFORMATION

1.1 ELECTRICAL SAFETY

WARNING: ELECTRICAL SHOCK HAZARD

Electrical connections shall be made by a qualified electrician in accordance with all applicable codes, ordinances and sound practices. Failure to follow these instructions could result in serious personal injury, death and/or property damage. Only qualified personnel who are familiar with the applicable National Code (USA = NEC) and local codes should install or repair electrical motors and their accessories.

 **WARNING: ELECTRICAL HAZARD:** Failure to connect motor and variable frequency drive in accordance with the drive manufacturer's documentation may result in serious injury, death, and/or property damage.

 **WARNING: ELECTRICAL LIVE CIRCUIT HAZARD**
Do not touch electrically live parts. Disconnect, lockout and tag input power supply before installing or servicing motor (includes accessory devices). Use a voltmeter to verify that power is off before contacting conductors.

 **WARNING: ELECTRICAL SHOCK HAZARD**
Shaft rotation produces voltage in PM motors even when motor is disconnected from power source. Do not open terminal box or touch unprotected terminals while the motor shaft is rotating. Failure to do so may cause serious injury or death to personnel.

 **WARNING: ELECTRICAL HAZARD**
Shaft rotation produces voltage in PM motors even when motor is disconnected from power source. Do not operate the motor or allow equipment to back drive the motor above the maximum RPM listed on the motor nameplate. Failure to do so may cause serious injury or death to personnel or damage the motor or system equipment.

 **WARNING: ELECTRICAL GROUNDING HAZARD**
Failure to properly ground motors, per the National Electrical Code (NEC) Article 430 and local codes may cause serious injury or death to

personnel. For general information on grounding refer to NEC Article 250. (Also see "Ground Connections section 3.4.4").

WARNING: MAGNETIC FIELD HAZARD

Permanent magnet motor rotors, when removed from the stator, expose surrounding personnel and equipment to powerful magnetic fields which may cause serious health hazards to persons with pacemakers, hearing aids, or other implanted electronic medical devices and may impact other electronic devices such as mobile phones, credit cards, etc.

NOTICE: MOTOR NOT SUITED FOR OPERATION ON LINE POWER

Permanent magnet (PM) motors can only be operated by a PM motor compatible VFD (Variable Frequency Drive). Connecting directly to line power may result in motor damage.

1.2 MECHANICAL SAFETY

WARNING: LOOSE PARTS HAZARD

Before starting the motor, remove all unused shaft keys and loose rotating parts to prevent them from flying off. Failure to follow these instructions could result in serious personal injury, death and/or property damage.

WARNING: ROTATING PARTS HAZARD

Keep extremities, hair, jewelry and clothing away from moving parts. Failure to follow these instructions could result in serious personal injury, death and/or property damage. See section 3.3.7.

WARNING: DO NOT DISASSEMBLE:

Due to powerful magnetic fields, disassembly and assembly of permanent magnet motors should only be performed by the manufacturer or specialized personnel authorized by the manufacturer. Only qualified personnel who are familiar with the applicable national codes, local codes and sound practices should install or repair electric motors and their accessories. See the Magnetic Field Hazard in section 1.1

1.3 ENVIRONMENTAL SAFETY

⚠ WARNING: HAZARDOUS LOCATIONS

The NEC and the local authority having jurisdiction must be consulted concerning the installation and suitability of motors for use in Hazardous Locations, in accordance with NEC Article 500. The local authority having jurisdiction must make the final determination of what type of motor is required. The application and operation is beyond the control of the motor manufacturer. Failure to do so may cause serious injury or death to personnel.

2.0 RECEIVING AND INSPECTION

2.1 INITIAL INSPECTIONS

⚠ WARNING: ELECTRICAL SHOCK HAZARD

Shaft rotation produces voltage at motor leads and connected equipment even when motor is disconnected from power source. Do not open terminal box or touch unprotected terminals while the motor shaft is rotating. Failure to do so may cause serious injury or death to personnel.

2.1.1 CHECK PACKING LIST AND INSPECT the packaging to make certain no damage has occurred in shipment. If there is visible damage to the packaging, unpack and inspect the motor immediately. Claims for any damage done in shipment must be made by the purchaser against the transportation company.

2.1.2 TURN MOTOR SHAFT (see Electrical Shock Hazard above) by hand to be certain that it rotates freely. Note: Motor will not turn freely if leads are shorted together. User may feel small pulsations when turning shaft due to the magnets in rotor. Shaft seals and bearing seals may add drag.

⚠ **CAUTION:** Observe caution when working near threads or keyways. Finger or ring contact may cause injury.

2.1.3 CHECK NAMEPLATE for conformance with purchase order requirements and compliance with power supply and control equipment requirements.

2.2 HANDLING

⚠ WARNING: FALLING OBJECT HAZARD

Eyebolts or lifting lugs, where provided, are intended for lifting only the motor and accessories mounted by the motor manufacturer (unless specifically stated otherwise on the motor). Utilizing the motor lifting provision to lift other components such as pumps and gear boxes could result in serious personal injury, death and/or property damage.

⚠ WARNING: FALLING OBJECT HAZARD

Before using the lifting provision, check the eyebolts and/or other lifting means to assure they are not bent or damaged and are completely threaded, seated & secured to the motor. Equipment to lift motor must have adequate lifting capacity. While lifting the motor, DO NOT stand under or in the vicinity of the motor. Failure to follow these instructions could result in serious personal injury, death and/or property damage.

2.2.1 LIFTING ANGLE LIMITATIONS

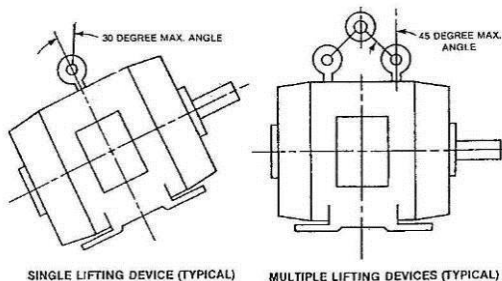

2.3 STORAGE: Motors, not put into service immediately, must be stored indoors in a clean, dry location. Avoid locations with large temperature swings that will result in condensation. Motors must be

covered to eliminate airborne dust and dirt. If the storage location exhibits high vibration, place isolation pads under motor to minimize damage to motor bearings.

2.3.1 BEARING LUBRICATION: Bearings are grease packed at the factory; relubrication upon receipt of motor or while in storage is not necessary. If stored more than one year, add grease per lubrication instructions (Table 4-4) before start-up.

2.3.2 SHAFT ROTATION: (see Electrical Shock Hazard Warning in section 2.1) It is recommended that the motor shaft be rotated 5 to 10 rotations every three months to distribute the grease in the bearings. This will reduce the chance for corrosion to form on the bearing rolling elements and raceways. Note: User may feel small pulsations when turning shaft due to the magnets in rotor. Shaft seals and bearing seals may add drag.

2.3.3 DAMP OR HUMID STORAGE LOCATIONS: Treat unpainted flanges, shafts, and fittings with a rust inhibitor. Apply appropriate power to the motor's space heaters (if so equipped).

3.0 INSTALLATION AND OPERATION

⚠ WARNING: ELECTRICAL SHOCK HAZARD

Only qualified personnel who are familiar with and understand the appropriate national codes, local codes and sound practices should install or repair electrical motors and their accessories. Installation should conform to the appropriate national code as well as local codes and sound practices. Failure to follow these instructions could result in serious personal injury, death and/or property damage.

⚠ WARNING: ELECTRICAL LIVE CIRCUIT HAZARD

Do not touch electrically live parts. Disconnect, Lockout and Tag input power supply before installing or servicing motor (includes accessory devices). Use a voltmeter to verify that power is off before contacting conductors.

⚠ WARNING: ELECTRICAL SHOCK HAZARD

Shaft rotation produces voltage at PM motor leads and connected equipment even when motor is disconnected from power source. Do not open terminal box or touch unprotected terminals while the motor shaft is rotating. Failure to do so may cause serious injury or death to personnel.

⚠ WARNING: ELECTRICAL SAFETY

Refer to Section 1.0 for additional warnings before proceeding with installation and operation.

3.1 LOCATION

3.1.1 SELECTING A LOCATION: Consideration should be given to environment and ventilation. Motors should be installed in an area that is protected from direct sunlight, corrosives, harmful gases or liquids, dust, metallic particles, and vibration. A motor with the proper enclosure for the expected operating condition should be selected. Provide accessible clearance for cleaning, repair, service, and inspections (See section 3.1.3 for construction clearances). The location should be considered for possible future motor removal or motor handling. The free flow of air around the motor should not be obstructed.

3.1.2 AMBIENT TEMPERATURE LIMITS: The ambient temperatures of the air inlet to the motor should not exceed 40°C (104°F) or be less than -30°C (-22°F) unless the motor nameplate specifically states an ambient temperature outside of these limits. The ambient inside an enclosure built around the motor shall not exceed the nameplate ambient. For ambient temperatures outside of these limits consult the motor manufacturer.

NOTICE: INSULATION DEGRADATION WARNING

Insulation at high temperatures ages at an accelerated rate. Each 10°C increase in temperature reduces the insulation life by one half.

3.1.3 CONSTRUCTION SELECTION PER LOCATION

3.1.3.1 TOTALLY ENCLOSED MOTORS are suitable for indoor or outdoor standard service applications. Severe duty construction is recommended for severe service applications.

TEAO or AOM (Totally Enclosed Air Over) motors must be mounted in the air stream. When the motor nameplate states a minimum airflow the motor must be mounted in an air stream meeting this minimum value.

TEFC (Totally Enclosed Fan Cooled) motors must meet a minimum distance equal to ½ the shaft height between the fan guard grill openings and the nearest obstruction.

3.1.3.2 HAZARDOUS LOCATIONS MOTORS: Not all motors covered by this manual are intended for hazardous duty locations. Motors intended for hazardous duty locations are labeled with the division and class.

⚠ WARNING: HAZARDOUS LOCATIONS

Hazardous Locations motors are intended for installations in accordance with NEC Article 500. For all installations involving Hazardous Locations motors, consult the applicable national codes, local codes, and the authority having jurisdiction. Failure to do so may cause serious injury or death to personnel.

Division 2 Installations – Class I only: Use only motors that are CSA Certified and bear the CSA Certification Mark. These motors include a phrase on the main motor nameplate that indicates the motor is CSA Certified for Class I, Division 2 / Zone 2 locations.

⚠ WARNING: EXPLOSION HAZARD

A motor should never be placed in an area with a hazardous process or where flammable gases or combustible materials may be present unless it is specifically designed and nameplated for this type of service. Hazardous Locations motors are intended for installations in accordance with NEC Article 500. For all installations involving Hazardous Locations motors, consult the NEC, local codes, and the authority having jurisdiction. Failure to follow these instructions could result in serious personal injury, death and/or property damage. (For other limitations see section 1.3).

3.2 MOUNTING MOTOR

3.2.1 RIGID BASE (FOOTED): The motor must be securely installed to a rigid foundation or a mounting surface to minimize vibration and maintain alignment between the motor shaft and the load's shaft. The mounting surfaces of the four mounting pads must be flat within 0.01 inches for 210 frame & smaller; 0.015 inches for 250 frame & larger. [IEC 0.25 mm for 130 frame & smaller, 0.38 mm for 160 frame & larger]. This may be accomplished by shims under the motor feet. For special isolation mounting, contact manufacturer for assistance

3.2.2 RIGID BASE HOLE SELECTION -6 OR 8 HOLES

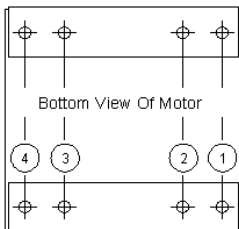

Location 1 and 3 holes for short frame:
(NEMA) 182, 213, 254, 284
(IEC) 112S, 132S, 160M, 180M

Location 2 holes are for F1,
F2 Conversion (if provide)

Location 1 and 4 holes for long frames:
(NEMA) 184, 215, 256, 286
(IEC) 112M, 132M, 160L, 180L

3.2.3 VERTICAL MOUNTING

⚠ WARNING: FALLING OBJECT HAZARD

The lifting provision on standard horizontal footed motors is not designed for lifting the motor in a vertical shaft up or shaft down position. (see Diagram 2.2.1). Doing so may cause the motor to

fall. Lifting method / provisions for mounting a rigid base (footed) motor vertically is the responsibility of the installer.

VERTICAL SHAFT DOWN: Most standard horizontal motors through 449 Fr. (excluding brake motors) can be mounted in a vertical shaft down orientation. For vertical brake motors see section 3.3.6.2.

VERTICAL SHAFT UP:

⚠ WARNING: HAZARDOUS LOCATIONS VERTICAL MOUNT: Hazardous locations motors must **NOT** be mounted vertically shaft up without approval by the motor manufacturer. Without proper retaining provisions the rotor may move axially and contact components, creating a spark hazard.

Belted or Radial Load when mounted vertically: The following frame sizes / constructions with applied (axial) down loads within the limit stated are acceptable when mounted vertical shaft up.

Table 3-1 Belted or Radial Load Applications (All speeds)

Frame Size	Enclosure	Construction	Shaft Up OK	Max Applied Down Load2
180	TEFC	All	Yes	35 lbs
210	TEFC	All	Yes	40 lbs
250	TEFC	All	Yes	40 lbs
280	TEFC	Cast Iron	Yes	30 lbs

Notes:

The max applied down load is any applied load external to the motor, including such things as sheave weight, fan loads, axial belt force, pump load, etc. If the application is direct drive with no applied radial load or is beyond the limits listed, consult the motor manufacturer.

3.3 APPLICATION ASSEMBLY TO MOTOR

NOTICE: EQUIPMENT DAMAGE

Do not connect or couple motor to load until correct rotational direction is established.

3.3.1 GENERAL: PROPER ALIGNMENT of the motor and driven equipment minimizes vibration levels, maximizes bearing life, and extends the overall life of the machinery. Consult the drive or equipment manufacturer for more information.

NOTICE: BEARING FAILURE

During assembly do **NOT** force components onto the shaft. Striking or hammering the component may result in bearing damage.

3.3.2 DIRECT COUPLING: Use flexible couplings if possible.

For applications that apply radial, axial or moment loading on the motor shaft see section 3.3.3.

NOTICE: BEARING FAILURE

Unless approved by the motor manufacturer, do **NOT** direct couple a vertical shaft up motor or roller bearing motor. Direct coupling a vertical shaft up motor or a motor with a roller bearing may result in bearing damage.

3.3.3 DIRECT CONNECTED: Radial loading for direct connected equipment (gears, fans etc.) must be approved by the motor manufacturer unless within the maximum overhung load limits (Table 3-2). Combined loading (axial, radial and/or moments) must be approved by motor manufacturer. For belted loads see section 3.3.4.

Table 3-2 Maximum Radial Load (pounds force) @ Middle of the Shaft Extension Length

NEMA Frame	Motor Rated RPM			
	3600	1800	1200	900
182T	187	230	261	287
184T	193	237	273	301
213T	319	317	470	510
215T	327	320	480	533
254T	500	631	729	793
256T	510	631	736	820
284T	-	866	990	1100
286T	-	871	1005	1107

Values based on 26,280 hrs B-10 Life
For "End of Shaft" Load multiply value by 0.88

3.3.4 BELTED

The goal of any belted system is to efficiently transmit the required torque while minimizing the loads on the bearings and shafts of the motor and driven equipment. This can be accomplished by following four basic guidelines:

1. Use the largest practical sheave diameter.
2. Use the fewest number of belts possible.
3. Keep sheaves as close as possible to support bearings.
4. Tension the belts to the lowest tension that will still transmit the required torque without slipping. V-belts may squeal initially in high starting torque applications.

3.3.4.1 Sheave Diameter Guidelines

In general, smaller sheaves produce greater shaft stress and shaft deflection due to increased belt tension. See Table 3-3 (next page) for recommended minimum sheave diameters. Using larger sheaves increases the contact with belts which reduces the number of belts required. It also increases the belt speed, resulting in higher system efficiencies. When selecting sheaves, do not exceed the belt manufacturer's recommended maximum belt speed, typically 6,500 feet per minute for cast iron sheaves. Determine belt speed by the following formula:

$$\text{BELT SPEED (Ft/min)} = \frac{\text{Shaft RPM} \times 3.14 \times \text{Sheave Dia (inches)}}{12}$$

Figure 1

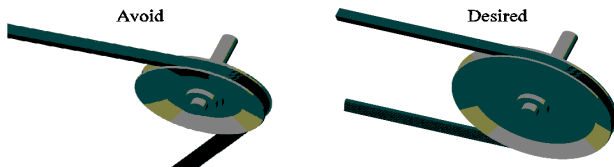
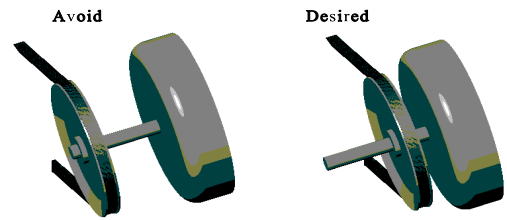

Figure 2



3.3.4.4 Belt Tension

⚠ WARNING: EQUIPMENT FAILURE

Excessive belt tension may lead to bearing failure and/or shaft failure. Failure to properly tension belts may result in serious personal injury, death, and/or property damage. Belt tension must be adjusted using a belt tension gage. Adjusting belt tension by "feel" (i.e., pushing on belt with fingers or hand) may result in excessive belt tension.

In general, belt tensions should be kept as loose as possible while still transmitting the required torque without slipping. Belt tensions must be measured with a belt tension gage. These inexpensive gages may be obtained through belt manufacturers or distributors. V-belts may squeal initially in high starting torque applications.

Proper belt tension is determined by measuring the force required to deflect the center of the belt a given distance. The proper deflection (in inches) is determined by dividing the belt span in inches by 64. Calculate the proper deflection and then see Table 3-3 (next page) for the required "Average Deflected Force" to achieve that deflection.

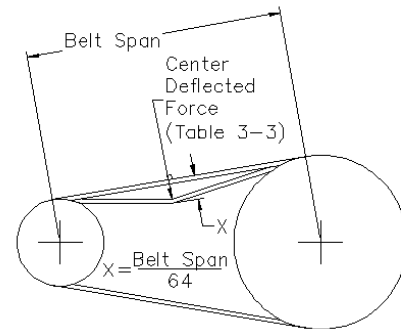

After tensioning the belt, rotate the sheaves for several rotations or operate the system for a few minutes to seat belts into the grooves, then re-tension the belts. New belts will stretch during use, and should be retensioned after the first eight hours of use.

3.3.4.2 Number of Belts

In general, use the fewest number of belts that will transmit the required torque without slipping. See Table 3-3 (next page) for recommended maximum number of belts. Each belt adds to the tension in the system, which increases load on the shafts and bearings. Belts are most efficient when operated at or near their rated horsepower.

If the sheaves have more grooves than the number of belts required, use the grooves closest to the motor.

3.3.4.3 Sheave Location

Install sheaves as close to the housing as possible to increase the bearing life of the motor and driven equipment.

3.3.5 PERMANENT MAGNET MOTOR VFD (Variable Frequency Drives) OPERATION

⚠ CAUTION: Power Factor Correction Capacitors

Placing power factor correction capacitors between the motor and VFD may cause personal injury and significant damage to the VFD. Power factor correction capacitors should never be installed between the VFD and the motor and should not be installed at VFD input unless approved by VFD manufacturer.

NOTICE: MOTOR NOT SUITED FOR OPERATION ON LINE POWER

PM motors can only be operated by a PM motor compatible VFD. Connecting directly to line power may result in motor damage. Consult VFD installation and operation manual for additional instructions and safety information.

Table 3-3 Recommended Minimum Sheave Diameters, Belt Type, Number of Belts and Deflected Force

Motor Hp	1200 rpm				1800 rpm				3600 rpm			
	Min Sheave Dia (in)	Belt Type	Max # of Belts	Avg. Deflected Force (lbs)	Min Sheave Dia (in)	Belt Type	Max # of Belts	Avg. Deflected Force (lbs)	Min Sheave Dia (in)	Belt Type	Max # of Belts	Avg. Deflected Force (lbs)
0.75	2.2	3VX	1	3.4	2.2	3VX	1		2.2	3VX	1	
1	2.4	3VX	1	4.0	2.2	3VX	1	3.1	2.2	3VX	1	
1.5	2.4	3VX	2	3.1	2.4	3VX			2.2	3VX	1	2.5
2	2.4	3VX	3	2.8	2.4	3VX	2	2.9	2.4	3VX		
3	3.0	3VX	2	3.3	2.4	3VX	3	2.9	2.4	3VX	2	2.3
5	3.0	3VX	3	4.0	3.0	3VX	3	3.7	2.4	3VX	3	2.5
7.5	3.8	3VX	4	4.7	3.0	3VX	4	4.1	3.0	3VX	2	4.2
10	4.4	3VX	4	5.4	3.8	3VX	4	4.3	3.0	3VX	3	3.8
15	4.4	3VX	5	5.4	4.4	3VX	4	5.4	3.8	3VX	3	4.4
20	5.2	3VX	6	6.0	4.4	3VX	6	4.8	4.4	3VX	3	5.0
25	6.0	3VX	7	5.6	4.4	3VX	7	5.2	4.4	3VX	4	4.7
30	6.8	3VX	7	5.9	5.2	3VX	7	5.3				

Notes:

- The ratings listed above assume normal frame size assignments per NEMA MG-1 (2009) Table 13.2. Horsepower is the nameplate motor horsepower, and RPM is the motor (driver) speed.
- Minimum sheave diameters are from NEMA standards where applicable.
- For variable speed applications or values outside these recommendations, consult motor manufacturer.**
- Selections are based on a 1.4 belt service factor, 5 to 1 speed reduction and various Power Transmission Manufacturers' catalogs.
- These selections are for Narrow V-belt sections only. Consult motor manufacturer for details on conventional V-belt sections (A, B, C, D and E), or other belt types.
- "Average Deflected Force" is per section 3.3.4.4 of this document and is the force required to deflect the center of a belt 1/64 of the belt span distance. Tolerance on this force is ±1 lbf for forces ≤10 lbs, and ±2 lbs for forces >10 lbs as measured utilizing a belt tension gage.
- When more than one belt is required, the belts must be a matched set (matched for length).
- If possible, the lower side of the belt should be the driving side to increase the length of wrap on the sheave.
- Do not exceed nameplate maximum RPM.

NOTICE: VFD / Motor Setup

It is the responsibility of the startup personnel during set up of the VFD / motor system to properly tune the drive to the motor for the specific application per the VFD user manual. The correct voltage boost, volts per hertz, and overload current level settings are application dependent and unique to each motor design. Current setting shall not exceed nameplate service factor amps. Failure to connect over temperature devices (when provided) will void the warranty.

3.3.5.1 Overspeed Capability

Do not exceed nameplate maximum RPM without first contacting manufacturer.

⚠ WARNING: ELECTRICAL HAZARD

Shaft rotation produces voltage in PM motors even when motor is disconnected from power source. Do not operate the motor or allow equipment to back drive the motor above the maximum RPM listed on the motor nameplate. Failure to do so may cause serious injury or death to personnel or damage the motor or system equipment.

3.3.5.2 Cable Lengths: These motors are equipped with an insulation system designed for use with variable frequency drives. For optimum insulation life, limit VFD to motor cable lengths as documented in Table 3-5. For additional information, or for installations requiring longer cable runs, please contact the motor manufacturer.

Table 3-5 Max Cable Lengths

These values are based on 3 kHz carrier frequency. Add suitable VFD output-side filters when exceeding the listed values.

Frame Size	230V	460 V	575 V
NEMA 180-280	2000 ft.	2000 ft.	650 ft.
IEC 112-180	600 m.	600 m.	200 m.

3.3.5.3 VFD Grounding: See Grounding section 3.4.4

3.3.5.4 Stray Voltage on Accessory Leads

VFDs will couple stray voltage to accessories such as RTDs, thermistors, thermostats and space heaters. The leads of these elements must be properly insulated and control input circuits must be designed to withstand this voltage.

3.3.6 ACCESSORIES / PROVISIONS

3.3.6.1 General: Carefully read and understand the accessory manufacturer's instructions, supplied with motor. Contact the manufacturer for additional information.

3.3.6.2 Brake Motors

⚠ WARNING: Backup Brake System

Failure of the brake may put people in the vicinity of the motor at risk for serious personal injury or death, or cause damage to nearby equipment. If people or equipment will be in the vicinity of the motor, a backup system should be supplied.

⚠ WARNING: Vertical Motor Premature Brake Failure

Motors with brakes that are designed for vertical applications are equipped with springs to support the brake pressure plate. Mounting a horizontal brake motor vertically shaft up or down may require a pressure plate spring modification. Failure to modify the brake for the vertical application may result in premature brake failure, creating a risk of serious personal injury or death and/or equipment damage. If in question, consult brake literature or brake manufacturer.

⚠ WARNING: DO NOT CONNECT BRAKE SOLENOID to the output of a VFD. The brake solenoid must be wired to 50/60 Hz line power for proper operation. Failure to do so may result in brake damage, potentially leading to serious injury, death, or equipment damage.

3.3.6.3 Space Heaters

Motors provided with space heaters have two leads that are brought into the conduit box or into an auxiliary box. These leads are marked "H1", "H2" ("H3", "H4" if a second space heater is supplied). See the space heater nameplate on motor for heater rating.

⚠ WARNING: DIVISION 2 EXPLOSION HAZARD

The space heater temperature rating when used in Class I, Division 2 motors shall **NOT** exceed 80% of the auto ignition temperature of the hazardous gas or vapor. See the space heater nameplate on motor for heater Temperature Code and heater rating. Failure to follow this instruction could result in serious personal injury, death and/or property damage

3.3.6.4 Thermal Protection

General Information: When thermal protection is provided, "WITH OVERHEAT PROTECTIVE DEVICE" will be stamped on the nameplate. The motor is provided with an overheat protective device that does not directly open the motor circuit. Motors nameplated with this phrase have either thermostats, thermistors or RTDs. The leads to these devices are routed into the motor conduit box or into an auxiliary box. The lead markings are defined on the nameplate.

THERMOSTAT: The circuit controlled by the thermostats must be limited to a maximum of 600 volts and 360 volt-amps. See connection decal provided inside the terminal box cover. Failure to connect these over temperature devices (when provided) will void the motor warranty.

THERMISTERS OR RESISTANCE TEMPERATURE DETECTORS (RTDs)

These sensors are to be connected to a solid state resistance monitoring device designed for use with thermistors or RTDs. Failure to connect these over temperature devices (when provided) will void the motor warranty.

3.3.6.5 RTD Alarm & Trip Settings

Tables 3-6 & 3-7 are suggested initial RTD alarm and trip settings. For motors found to operate significantly below these values the settings may be reduced accordingly.

**Table 3-6 Winding RTD – Temperature Limit (8C)
40 8C Max Ambient**

Temperature (degrees C)	
Alarm	Trip
130	140

**Table 3-7 Bearing RTD – Temperature Limit (8C)
40 8C Max Ambient**

Bearing Type	Alarm	Trip
Standard bearings	110	115
Motors specified with heat stabilized bearings to 150 C	130	135

3.3.7 GUARDS

⚠ WARNING: ROTATING PARTS HAZARD

When devices are assembled to the motor shaft, be sure to install protective devices such as belt guards, chain guards, and shaft covers. These devices must protect against accidental contact with extremities, hair, and clothing. Consider the application and provide guarding to protect personnel. Remove all unused shaft keys and loose rotating parts to prevent them from flying off and causing bodily injury. Failure to follow this warning could result in serious personal injury, death and/or property damage.

3.4 ELECTRICAL CONNECTIONS

⚠ WARNING: ELECTRICAL HAZARDS

Before proceeding read Section 1.1 on Electrical Safety. Failure to follow the instructions in Section 1.1 could result in serious personal injury, death and/or property damage

⚠ WARNING: ELECTRICAL SHOCK HAZARD: Voltage may be present at the motor terminals even after the motor has stopped rotating. To assure there is no voltage at motor, remove input power from VFD and follow VFD manufacture documentation for voltage decay time before servicing motor. Failure to follow this instruction could result in serious personal injury or death.

NOTICE: MOTOR NOT SUITED FOR OPERATION ON LINE POWER

Permanent magnet motors can only be properly operated by a variable frequency drive (VFD). Attempting to run in bypass mode (across the line) may cause motor damage.

3.4.1 POWER SUPPLY / BRANCH CIRCUIT

⚠ WARNING: POWER SUPPLY INCOMPATIBILITY HAZARD

Check power supply to make certain that voltage, frequency and current carrying capacity are in accordance with the motor nameplate and VFD. Connecting the VFD to the wrong power source could result in serious personal injury, death and/or property damage

⚠ WARNING: BRANCH CIRCUIT SUPPLY HAZARD

Motor and control wiring, fusing, overload protection, disconnects, accessories and grounding must always conform to the applicable electrical codes as well as local codes and sound practices.

3.4.1.1 Fuses, Breakers, Overload Relays

Consult variable frequency drive (VFD) operating manual and applicable electric codes for branch circuit protection sizing.

⚠ WARNING: PROTECTIVE DEVICE DISABLED HAZARD

DO NOT bypass or disable these or other protective devices. Protection removal could result in serious personal injury, death and/or property damage.

3.4.1.2 AC Power Supply Limits

PM motors are designed to operate with variable frequency drives with rated input voltage 600 VAC or less. Drive RMS output voltage should not exceed motor nameplate voltage for which the motor is connected.

NOTICE: REDUCED MOTOR PERFORMANCE

Operation outside of these limits will degrade motor performance and increase operating temperature.

3.4.2 TERMINAL BOX

⚠ WARNING: ELECTRICAL SHOCK HAZARD

Shaft rotation produces voltage in PM motors even when motor is disconnected from power source. Do not open terminal box or touch unprotected terminals while the motor shaft is rotating. Failure to do so may cause serious injury or death to personnel.

3.4.2.1 Conduit Opening

For ease of connections, motors are typically provided with large terminal boxes. Most motors have conduit access in 90 degree increments, the terminal box conduit opening is typically provided via knockouts, holes with covers, or the terminal box is rotatable. Fabricated conduit boxes may have a removable plate for the installer to provide correctly sized hole(s).

3.4.3 LEAD CONNECTIONS

Electrical connections are to be made per nameplate connection diagram or separate connection plate. In making connections follow the applicable electrical code as well as local codes and practices.

⚠ WARNING: ELECTRICAL CONNECTION HAZARD

Failure to correctly connect the motor leads and grounding conductor can result in serious personal injury or death. Motor lead connections can short and cause damage or injury if not well secured and insulated.

3.4.4 GROUND CONNECTION(S)

⚠ WARNING: ELECTRICAL GROUNDING HAZARD

For general information on grounding (USA) refer to NEC Article 250. Improper grounding of an inverter fed motor may result in frame voltages in excess of 500 Volts. In making the ground connection, the installer must make certain that a good electrical connection is obtained between motor and grounding lead. Failure to properly ground motors, per the applicable national code (such as NEC Article 430) and local codes may cause serious injury or death to personnel.

Equalize ground potential between the motor and driven equipment if the driven equipment and motor are not mounted to the same metallic base plate.

3.4.4.1 Electrical Interference

Due to high switching frequencies of variable frequency drives, use a low resistance ground cable that is low impedance at high frequencies. A shielded motor power cable with a complete circumferential braided or copper film ground jacket around the power leads is recommended to minimize electrical interference. Secure this ground to both the motor's primary ground and the variable frequency drive ground.

Primary "Internal" Ground: A grounding conductor must be connected to the grounding terminal provided in the terminal housing. This grounding terminal is either a ground screw, ground lug, or a tapped hole to be used with a separately provided ground screw. The internal grounding feature is accessible inside the terminal housing and must be used as the primary grounding connection.

Secondary "External" Ground: Some motors are provided with a supplemental grounding terminal located on the external surface of the motor frame or feet. This external terminal is for supplemental grounding connections where local codes permit or require such connection.

3.4.5 START UP

⚠ WARNING: LOOSE & ROTATING PARTS HAZARD
Before proceeding read Section 1.2 on Mechanical Safety. Failure to follow the instructions could result in serious personal injury, death and/or property damage

⚠ WARNING: ELECTRICAL LIVE CIRCUIT HAZARD
Shaft rotation produces voltage in PM motors even when motor is disconnected from power source. Do not open terminal box or touch unprotected terminals while the motor shaft is rotating. Failure to do so may cause serious injury or death to personnel

⚠ WARNING: ELECTRICAL SHOCK HAZARD
Be certain that all connections are secure and the conduit box cover is fastened in place before electrical power is applied. Failure to follow these instructions could result in serious personal injury, death, and/or property damage.

⚠ WARNING: EXCESSIVE SURFACE TEMPERATURE HAZARDOUS LOCATIONS
Motors with the temperature code stated on the nameplate are designed to operate within this limit. Improper application or operation can cause the maximum surface temperature to be exceeded. A motor operated in a Hazardous Location that exceeds this surface temperature limit increases the potential of igniting hazardous materials. Therefore, motor selection, installation, operation, and maintenance must be carefully considered to ensure against the following conditions: (1) Motor load exceeds service factor value, (2) Ambient temperature above nameplate value, (3) Voltages outside of limits in Section 3.4.1.2, (4) Loss of proper ventilation, (5) VFD operation exceeding motor nameplate rating, (6) Altitude above 3300 feet / 1000 meters, (7) Severe duty cycles, (8) Repeated starts, (9) Motor stall, (10) Motor reversing, and (10) Single phase operation. Failure to follow these instructions could result in serious personal injury, death and/or property damage.

⚠ CAUTION: USER CONTACT OF HOT SURFACE
Normal motor surface temperatures may exceed 90 ° C (194° F). Touching the motor frame may cause discomfort or injury. Surface temperatures should only be measured with suitable instruments and not estimated by hand touch.

3.4.5.1 Start Up - No Load Procedure

⚠ WARNING: ROTATION HAZARD
Incorrect motor rotation direction can cause serious or fatal injury or equipment damage. Verify rotation direction before coupling to driven equipment.

1. **Check Instructions:** Before startup carefully read and fully understand these instructions including all warnings, cautions, and safety notice statements.

2. **Motor out of storage after more than three months:**
Check winding insulation integrity with a Megger. If winding resistance to ground is less than 1.5 Meg-ohms consult the local authorized service shop before energizing the motor.
3. **Check Installation: Mechanical** - Check tightness of all bolts and nuts. Manually rotate the motor shaft to ensure motor shaft rotates freely. Note: Motor will not turn freely if power leads are shorted together. User may feel small pulsations when turning shaft due to the magnets in rotor. Shaft & bearing seals will add drag.
Electrical - Inspect all electrical connections for proper terminations, clearance, mechanical tightness and electrical continuity. Be sure to verify connections are made per the nameplate connection diagram or separate connection plate. Replace all panels and covers that were removed during installation before energizing the motor.
4. **Energize Motor: Check Rotation**
If practical, check motor rotation before coupling to the load. If motor has a rotational arrow, only operate the motor in the rotation identified. Energize VFD and momentarily jog motor to verify direction of rotation. If opposite rotation is required, (a) select reverse rotation from VFD or (b) de-energize VFD, remove power, then reconnect motor leads for reverse rotation. Repeat jog cycle and ensure proper rotation.
5. **Record No Load Amps, Watts & Voltage:**
Recommend - To establish a baseline value check and record the no load amps, watts, and voltage.

3.4.5.2 Start Up – Load Connected Procedure

1. **Check Instructions:** Before startup carefully read and fully understand these instructions including all warnings, cautions, & safety notice statements.
2. **Coupling Installation:** Check that the connected equipment is properly aligned and not binding. Check that all guards and protective devices are properly installed.
3. **Energize Motor:** When all personnel are clear of the machine, apply power and verify that the load is not transmitting excessive vibration back to the motor through the shaft or the foundation. Verify that motor amps are within nameplate rating. The equipment can now be fully loaded and operated within specified limits as stated on the nameplate.

4.0 MAINTENANCE

⚠ WARNING: ELECTRICAL SHOCK HAZARD: Voltage may be present at the motor terminals even after the motor has stopped rotating. Disconnect power to the VFD and verify VFD DC output voltage is zero before performing service or maintenance. Failure to follow this instruction could result in serious personal injury or death.

⚠ WARNING: ELECTRICAL SHOCK HAZARD
Electrical connections are to be made by a qualified electrician in accordance with all applicable codes, ordinances and sound practices. Failure to follow these instructions could result in serious personal injury, death and/or property damage. Only qualified personnel who are familiar with the applicable national codes, local codes and sound practices should install or repair electric motors and their accessories.

⚠ WARNING: ELECTRICAL LIVE CIRCUIT HAZARD
Do not touch electrically live parts. Disconnect, lockout and tag input power supply before installing or servicing motor (includes accessory devices).

⚠ WARNING: ELECTRICAL LIVE CIRCUIT HAZARD
Shaft rotation produces voltage in PM motors even when motor is disconnected from power source. Do not open terminal box or touch unprotected terminals while the motor shaft is rotating. Failure to do so may cause serious injury or death to personnel

⚠ WARNING: DISASSEMBLY APPROVAL REQUIRED
Due to powerful magnetic fields, disassembly and assembly of permanent magnet motors should only be performed by the manufacturer or specialized personnel authorized by the manufacturer.

⚠ WARNING: MAGNETIC FIELD HAZARD
Permanent magnet motor rotors contain powerful magnetic fields. Exposure to magnetic field may cause serious health hazards to persons

with pacemakers, hearing aids, or other implanted electronic medical devices and may impact other electronic devices such as mobile phones, credit cards, etc.

⚠ WARNING: ELECTRICAL SAFETY

Refer to Section 1.0 for additional warnings before proceeding with maintenance.

4.1 GENERAL INSPECTION

Inspect the motor approximately every 500 hours of operation or every three months, whichever occurs first. Keep the motor clean and the ventilation and fin openings clear. The following steps should be performed at each inspection:

4.1.1 VENTILATION: Check that the ventilation openings and/or exterior of the motor are free of dirt, oil, grease, water, etc, which can accumulate and block motor ventilation. If the motor is not properly ventilated, overheating can occur and cause early motor failure.

4.1.2 INSULATION: To monitor motor insulation, disconnect motor from the VFD and use a “Megger” to take periodic readings. Record the Megger readings. If winding resistance to ground is less than 1.5 Meg-ohms consult the local authorized service shop before re-energizing the motor.

4.1.3 ELECTRICAL CONNECTIONS: With all power off and motor stopped, check all electrical connectors to be sure that they are tight.

4.1.4 SEAL CONDITION: When supplied, check the condition of shaft seals and replace if necessary.

4.1.5 SAFETY LABELS: Do not remove or cover safety labels. Inspect and clean safety labels to maintain visibility. Replace labels if they are no longer readable.

The lubricating ability of grease (over time) depends primarily on the type of grease, the size of the bearing, the speed at which the bearing operates and the severity of the operating conditions. Longer bearing life can be obtained if the listed recommendations are followed:

NOTE: If lubrication instructions are provided on the motor nameplate, the nameplate instructions will supersede these instructions. Motors marked “Permanently Lubricated” do not require additional service”.

NOTICE: BEARING / MOTOR DAMAGE

Lubricant should be added at a steady state of moderate pressure. If added under heavy pressure, bearing shield(s) may collapse. Over greasing bearings  greatly increases bearing friction and can cause premature bearing and/or motor failure.

4.2.1 GREASE TYPE (unless nameplate states otherwise)
Nameplate Ambient Temperature between -30°C (-22°F) to 65°C (150°F) inclusive: Recommended grease for standard service conditions is Polyrex EM (Exxon Mobil). Equivalent and compatible greases include: Texaco Polystar RB, Rykon Premium #2, Pennzoil Pen 2 Lube, Chevron SRI & Mobil SHC 100.

Nameplate Ambient Temperature below -30°C (-22°F): Special low temperature grease is recommended, such as Aeroshell 7 or Beacon 325 for ball bearings and Mobil SHC 100 for roller bearings.

Nameplate Ambient Temperature above 65°C (150°F): Dow Corning DC44 or equivalent, a special high temperature grease is required. Note that Dow Corning DC44 grease does not mix with other grease types.

4.2.2 BEARING OPERATING TEMPERATURE

⚠ CAUTION: HOT SURFACE

The external surface temperature of the end shield (bracket) bearing hub may reach 100° C (212° F) during normal operation. Touching this surface may cause discomfort or injury. Surface temperatures should only be measured with suitable instruments and not estimated by hand touch.

For RTD settings see Table 3-7.

4.2 LUBRICATION & BEARINGS

4.2.3 LUBRICATION INTERVALS (For motors with regreasing provisions)

Eq. 4.2 Lubrication Interval = [(Table 4-1) hrs] x [Interval Multiplier (Table 4-2)] x [Construction Multiplier (Table 4-3)]
 Recommended lubrication intervals are shown in Table 4-1. These values are based on average use.

Table 4-1 Lubrication Intervals

NEMA / [IEC] Frame Size	Operating Speed – RPM (See Table 3.4 for Maximum Operating Speed)					
	<7200	<5400	<4500	<3600	<1800	<1200
180 [110]	2500 Hrs.	4000 Hrs	5000 Hrs	6000 Hrs.	17000 Hrs.	20000 Hrs.
210-250 [130-160]		2500 Hrs	4000 Hrs	5000 Hrs.	12000 Hrs.	16000 Hrs.
280 [180]		2000 Hrs	3000 Hrs	4000 Hrs.	10000 Hrs.	14000 Hrs.

Seasonal Service: If motor remains idle for more than six months, Lubricate at the beginning of the season, then follow lubrication interval.
Do not exceed maximum safe operating speed without manufacturer’s approval

Table 4-2 Service Conditions

Use highest level Multiplier: Maximum Ambient Temperature and Contamination are independent factors

Severity of Service	Maximum Ambient Temperature	Atmospheric Contamination	Multiplier
Standard	Less than 40° C (104° F)	Clean, Slight Corrosion, indoors, less than 16 hrs per day	1.0
Severe	Above 40° C (104° F) to 50° C	Moderate dirt or Corrosion or outdoors or more than 16 hrs per day	0.5
Extreme	Greater than 50° C or Class H Insulation	Severe dirt or Abrasive dust or Corrosion	0.2

Table 4-3 Construction Multiplier

Construction	Multiplier
Angular Contact or Roller Bearing	0.5
Vertical Motor	0.5
All others	1.0

Table 4-4 Relubrication Amounts

Frame Size		Volume		
NEMA	IEC	Cu. In.	Fluid oz	ml
180	110	0.50	0.28	8.0
210	130	0.75	0.42	12.5
250	160	1.00	0.55	16.0
280	180	1.50	0.83	25.0

For regreasing while operating multiply volume by 125%.

**4.2.4 LUBRICATION PROCEDURE
(For Motors with Regreasing Provisions)**

NOTICE: BEARING DAMAGE WARNING

Added grease must be compatible with the original equipment's grease. If a grease other than those stated in 4.2.1 is to be utilized, contact the motor manufacturer. Nameplate information supersedes section 4.2.1 (GREASE TYPE). New grease must be free of dirt. Failure to follow these instructions and procedure below may result in bearing and/or motor damage.

NOTICE: GREASE DRAIN PLUGGED

Old grease may completely block the drain opening and must be mechanically removed prior to regreasing. Forcing a blocked drain open by increased greasing pressure may collapse bearing shields and / or force excess grease through the bearings and into the motor.

For an extremely dirty environment, contact the motor manufacturer for additional information.

LUBRICATION PROCEDURE:

1. Clean the grease inlet plug or zerk fittings prior to regreasing.
2. (If present) Remove grease drain plug and clear outlet hole blockage.
3. Add grease per Table 4-4
4. Re-install grease inlet and drain plugs (if removed).

4.2.5 EXAMPLE: LUBRICATION

Assume - NEMA 286T (IEC 180), 1750 RPM Vertical motor driving an exhaust fan in an ambient temperature of 43° C and the atmosphere is moderately corrosive.

1. Table 4-1 list 10,000 hours for standard conditions.
2. Table 4-2 classifies severity of service as "Severe" with a multiplier of 0.5.
3. Table 4-3 lists a multiplier value of 0.5 for "Vertical"
4. (Eq. 4.2) Interval = 10,000 hrs x 0.5 x 0.5 = 2500 hrs
5. Table 4-4 shows that 1.5 cubic inch of grease is to be added.

Relubricate every 2,500 hrs of service with 1.5 cubic inch of recommended grease.

4.3 TROUBLE-SHOOTING

⚠ WARNING: READ INSTRUCTIONS:

Before trouble-shooting a motor, carefully read and fully understand the warnings, cautions, & safety notice statements in this manual. Failure to do so could cause severe injury, death, and/or equipment damage

4.3.1 GENERAL TROUBLE SHOOTING

⚠ WARNINGS:

1. **Disconnect power to the VFD and verify VFD DC output voltage is zero before performing service or maintenance.**
2. **Always keep hands, hair, and clothing away from moving parts.**
3. **Be sure required safety guards are in place before starting equipment.**
4. **If the problem persists, contact the manufacturer.**

Motor Trouble-shooting Cause / Corrective Action - Table 4-5

⚠ Before conducting any trouble-shooting, be sure to read and follow all safety warnings and instructions. Failure to do so could cause severe injury, death, and/or equipment damage.

Issue	Likely Cause	Corrective Action
Motor fails to start upon initial installation		
A	Low or no input voltage to VFD.	(1) Ensure that rated input voltage is present at VFD. Ref. Section 3.4.1.2. (2) Check line fuses. Ref. Section 3.4.1.1.
B	Motor leads are not connected or miswired in conduit box or at VFD output terminals.	(1) Match motor lead wiring to motor nameplate connection diagram for operating voltage. Ref. Section 3.4.3. (2) Check continuity between VFD and motor terminals. Ref. Section 3.4.5.
C	Driven load exceeds motor/VFD capacity. VFD may trip on overload fault.	(1) Verify that VFD current / torque limit setting equals motor rated service factor amps (these parameters may be set to zero at the factory for safety purposes). Ref Section 3.3.5 (2) Verify that motor and VFD rating are adequate for application.
D	Load is jammed or motor is binding. VFD trips on overload fault.	(1) Verify that motor & load turn freely. Ref. Section 3.4.5. (2) Disconnect motor from load & ensure motor turns freely. Ref. Section 3.4.5. (3) Verify that motor starts when disconnected from load. Ref. Section 3.4.5. (4) Remove excessive / binding load if present.
E	Acceleration time set too short.	Increase acceleration to maximum acceptable time for the application.
F	VFD programmed incorrectly. VFD trips on overload fault.	(1) Repeat checks listed above. (2) Consult VFD service manual. Ref. Section 3.3.5.

Motor has been running, then slows down, stalls, or fails to restart

A	Drive has faulted.	Check fault codes on VFD and follow VFD troubleshooting procedures. Ref Section 3.3.5.
B	Supply voltage to VFD has drooped or has become severely unbalanced.	(1) Check fuse or reset circuit breaker. Ref. Section 3.4.1.1. (2) Verify that rated and balanced supply voltage has been restored at VFD input before restarting motor. Measure VFD input voltage after motor has reached set speed during restart. Ref. Section 3.4.1.2.
C	Motor is overloaded. VFD trips on overload.	(1) Verify that motor & load turn freely. Ref. Sections 3.3.5 and 3.4.5.
D	Motor bearings are seized.	(2) Disconnect motor from load & ensure motor turns freely. Ref. Section 3.4.5. (3) Verify that motor starts when disconnected from load. Ref. Section 3.4.5.
E	Load is jammed. VFD trips on overload.	(4) Remove excessive / binding load if present. (5) Motor may have overheated. Check thermostats and if tripped, allow motor to cool before attempting to restart. Ref. Section 3.3.6.4.
F	VFD will not restart motor after tripping.	(1) Check fault codes on VFD and follow VFD troubleshooting procedures. (2) Verify that VFD input voltage is balanced and within limits. Ref. Section 3.4.1. (3) Remove excessive mechanical load if present.
G	Rotor magnets have been partially demagnetized due to excessive heat or excessive current.	To diagnose, motor must be cooled to room temperature. Disconnect motor shaft from load and motor leads from VFD. Ref. Section 4.0. Connect AC volt meter across T1 and T2 motor leads. Drive motor at a speed below rated speed and measure both voltage generated and actual RPM. The voltage per 1000 rpm should match the nameplate value within 10%.

Motor takes too long to accelerate

A	Acceleration rate set too long.	(1) Decrease acceleration setting in VFD. (2) Make sure motor is wired to match VFD output voltage. (3) Verify motor nameplate voltage matches VFD output voltage. Ref. Section 3.4.1.2.
B	Supply voltage has drooped or become severely unbalanced.	Ensure that steady state supply voltage at VFD input terminals is within limits. Ref. Section 3.4.1.2. Correct as needed.
C	Load exceeds motor/VFD capability.	(1) Verify the motor rating and VFD current capability are sized correctly for the load. (2) Set current / torque limit setting to match the maximum motor capability. Ref. Section 3.4.5. (3) Disconnect motor from load & ensure motor turns freely. Ref. Section 3.4.5.

Motor rotates in the wrong direction

A	Motor lead wiring is reversed or commanded direction is reversed at VFD.	(1) Interchange any two motor leads between motor and VFD output terminals. Ref. Section 4.0. (2) Program direction change in VFD.
----------	--	---

VFD trips repeatedly on overload or motor over-temperature fault

A	Load exceeds motor/VFD capability.	(1) Verify the motor rating and VFD current capability are sized correctly for the load. (2) Set current / torque limit setting to match the maximum motor capability. Ref. Section 3.4.5. (3) Disconnect motor from load & ensure motor turns freely. Ref. Section 3.4.5.
B	Ambient temperature too high.	Confirm that ambient at motor does not exceed value stamped on motor nameplate. Reduce ambient as needed. Ref. Section 3.1.2.
C	Motor cooling fins and/or vent openings blocked.	Remove foreign materials – clear vent openings, fan guard air inlets and frame fins (TEFC motors). Ref. Section 4.1.1.
D	Insufficient Air Flow.	TEAO (Totally Enclosed Air Over) motors: Measure airflow next to motor surface and obtain minimum requirements from motor manufacturer. Ref. Section 3.1.3.1.
E	Load acceleration time is set too short.	Increase acceleration time as needed.
F	Start/stop time (duty cycle) is too short or too frequent.	(1) Increase acceleration/deceleration times. (2) Reduce the number of start/stop cycles.

Motor Vibrates

A	Motor misaligned to load.	Realign load.
B	Load out of balance.	(1) Ensure that load is dynamically balanced. (2) Verify that motor shaft is not bent. Uncouple motor from load and inspect motor shaft. Rule of thumb is 0.002" runout for shafts extension lengths up to 3.00". Add 0.0005" per every additional inch of shaft length beyond 3.00".
C	Uneven tension on multiple belts.	(1) Belts are not evenly worn. Realign motor to load and replace all belts. Ref. Section 3.3.4. (2) A mix of new and used belts is used. Replace multiple belt applications with a complete set of matched belts. Ref. Section 3.3.4.
D	Driven load operating at resonant point / natural frequency.	(1) De-energize motor and record vibration as load coasts from 100% speed to 0 RPM. If vibration drops immediately, vibration source is electrical. If levels do not drop immediately, source is mechanical. (2) If electrical sources, program skip frequencies to bypass resonant points. (3) If mechanical, redesign system to operate below the resonant point.

E	Uneven, weak or loose mounting support.	Shim, strengthen or tighten where required.
F	Motor bearings worn.	Uncouple motor from load and rotate shaft by hand. Ref section 2.1.2. If you hear noise or feel roughness, have bearings replaced. Ref Section 4.0. For motors with regreasing provisions, add grease per relubricating instructions. Ref. Section 4.2.3. If noise persists contact motor manufacturer.
G	Motor out of balance.	Motor is balanced at the factory and will remain balanced in operation. If motor balance is in question, remove motor from application and send to a motor manufacturer authorized service shop for inspection. Do not attempt to disassemble motor in the field.
Bearings repeatedly fail		
A	Load to motor may be excessive or unbalanced.	(1) If belt drive, check system per section 3.3.4. (2) Other than belting, check loading on motor shaft. An unbalanced load will also cause the bearings to fail. (3) Check run-out of mating components, such as a C-face and pump flange.
B	Bearings contaminated.	Motor enclosure not suitable for environment. Replace with correct enclosure construction.
C	Incorrect grease or bearings for ambient extremes.	See section 4.2.1.
Motor makes a rubbing, grinding, or squealing noise		
A	Contact between rotating and stationary components.	Isolate motor from load. To locate point of contact turn motor shaft by hand. Ref. Section 2.1.2. If point of contact is not located, contact motor manufacturer authorized service shop.
VFD trips on Ground Fault		
A	VFD trips at low speed during starting. Voltage boost is set too high.	Reduce boost, repeat auto tune.
B	Condensation forms on motor winding.	Remove source of moisture. Dry out motor. Add space heaters to motor. Ref. Section 3.3.6.3 and 4.0.
C	Motor winding is shorted to ground.	Disconnect leads at motor conduit box and Megger motor leads to ground. Ref. Section 4.1.2. If resistance is less than 1.5 mega-ohms, remove motor from service. Service shop must check for excessive moisture or contamination on windings or short to ground.
Motor shaft cogs		
A	Shaft cogs when turned by hand.	Motor leads are shorted together inside conduit box producing braking torque. Isolate all leads and repeat shaft turning by hand. Ref. Section 3.4.5.1.
B	Shaft cogs when operated by VFD.	Voltage boost is excessive. Reduce boost. Repeat auto tune.
VFD trips during deceleration		
A	VFD cannot absorb regenerated power.	(1) Add dynamic brake resistors or change VFD to line-regenerative design. For multi-drive installations, connect drives in common bus configuration to share regenerated power. (2) Increase capacity of dynamic braking circuit.
B	Deceleration time is set too fast. VFD's dynamic braking circuit overloads.	Increase deceleration time to reduce regenerated energy.